

RETAIL PRICE CATALOGUE

EFFECTIVE 1ST MAY 2022

BATHROOMS

FLOW CONTROL

SAFE-ASSIST HEALTHCARE



PURCHASE ORDERS

- Email purchase orders directly to invoicing@con-serv.com.au.
- Fax orders to (07) 3630 5755.
- All purchase orders must include the official purchase order number, Con-Serv product code, quantity required, store details, contact number and minimum order freight charge when applicable.
- Project purchases - refer to PROJECT QUOTATIONS.
- Purchase orders delivered direct to secondary sites (e.g. building site) will incur additional freight charges - please see DELIVERY SERVICES below.

ONLINE ORDERS

- Con-Serv's Online Ordering System allows successfully registered Con-Serv account customers to process orders through the Con-Serv website.
- To access, customers must have an existing Con-Serv trade account, and have successfully registered for an online account on our website www.con-serv.com.au/register. Please note, not all trade accounts automatically qualify for an online account. For more information, please contact our customer service team on (07) 3630 5744 or mail@con-serv.com.au.
- After an online account has been approved, users can log in to view their custom pricing, place an order, review past orders and check the status of an order.
- All Freight Delivery Requirements and Delivery Services as outlined below apply to online ordering.
- Con-Serv do not accept online payment for goods. All online orders will be processed and invoiced as per our standard terms and conditions.

FREIGHT DELIVERY REQUIREMENTS

- Purchase orders valued over \$200 including GST will be delivered FREE INTO STORE
- Purchase orders valued under \$200 including GST will incur a \$19.80 GST inclusive freight delivery charge.
- Grab rails with dimensions exceeding 1500mm incur an oversize delivery charge. This charge will be confirmed by quotation prior to processing the purchase order.
- Destination surcharges will apply for some regional locations. Check our website www.con-serv.com.au/freight for postcodes and charges which must be included with your purchase order.
- All urgent orders requiring a priority delivery incur a freight delivery charge. Email invoicing@con-serv.com.au for a priority freight quotation. Please include the quotation amount on the purchase order.
- These freight delivery requirements will be held firm unless an unexpected or unusual freight cost increase occurs.
- In the event of there being any conflict between conditions of sale and conditions of purchase, or any other terms by the buyer, Con-Serv's conditions of sale will prevail unless otherwise agreed in writing.

DELIVERY SERVICES

- Con-Serv bathroom and healthcare products are made to order, assembled and packaged in our Brisbane factory, with delivery subject to production schedules. We endeavour to despatch all orders in a timely manner.
- Purchase orders will be despatched via Road Express Service. Refer to delivery schedule below for ETA.
- Purchase orders required for delivery to secondary sites will incur an additional freight charge. Email invoicing@con-serv.com.au for a quotation and include the quoted amount on the purchase order.
- Special make and fixed design healthcare products will be subject to freight charges. Email quotes@con-serv.com.au for a quotation and include the quoted amount on the purchase order.

DELIVERY SCHEDULE

South East Queensland	2 working days
Rest of Queensland	3-7 working days
New South Wales	3 working days
Victoria	3 working days
South Australia	7 working days
Tasmania	7 working days
Western Australia	7 working days
Northern Territory	7 working days

Not a time guaranteed service

HEAD OFFICE

Email

mail@con-serv.com.au

Phone

(07) 3630 5744

1300 467 322

Fax

(07) 3630 5755

PROJECT QUOTATIONS

- Con-Serv will offer preferential pricing for project and commercial quantities.
- Any reductions, variations or split deliveries from the original offer will require a separate quotation and applicable freight charges.
- Project quotations will be held until the expiry date specified on the quotation.
- All purchase orders resulting from a quotation must include the specified quotation number.

STOCK RETURNS

- For store purchasing errors, customer changes and cancellations, including specified project item(s) returns, a 15% stock return fee will apply on the net value of the returned item(s). The stock return fee will be waived should the item(s) be returned at the expense of the purchaser, within 28 days of stock receipt date.
- Please report any goods received damaged within 7 days. Any damages reported after this period will require goods to be returned at the purchaser's expense.
- All goods returned through store purchase errors, customer changes and cancellations must be received undamaged and in original condition.
- Special make products are non-returnable.
- Item(s) not returned within 12 months of the original purchase date will not be accepted for credit.

CREDITS

- Credits will not be approved without an authorisation number from Con-Serv head office.
- Credits are only subject for approval once item(s) have been inspected upon return.
- Credit authorisations will be cancelled if the item(s) are not returned within 90 days of authorisation.

OUR PROMISE

Con-Serv Corporation Australia Pty Ltd warrants all of its products (as below) with a 20 year warranty on all mechanical parts from manufacturing defects in materials and workmanship under normal use in a domestic installation for as long as the original purchaser owns their home into which the particular product(s) was/were installed. A 7 year warranty (also on the terms below) will apply to commercial installations, irrespective of ownership.

Con-Serv will repair or replace defective items correctly installed as per the Con-Serv installation instructions. Con-Serv will not be liable for defects arising through normal wear and tear. Item(s) must be returned with proof of purchase to Con-Serv at 17 Glentanna Street, Kedron, Queensland 4031. We will attend to your warranty claim after we make appropriate investigations. Contact our Service Manager during normal office hours on 1300 467 322 or email warranty@con-serv.com.au. If a warranty claim is accepted, Con-Serv will bear the reasonable costs of the return of the defective item(s) to us. A claim for expenses associated with making a claim for a defective product must be in writing and submitted to us with copies of supporting documents. The benefits given under our warranty are in addition to other rights and remedies of the customer under a law in relation to goods and services to which this warranty relates. Our goods come with guarantees that cannot be excluded under the Australian Consumer Law. You are entitled to a replacement or a refund for a major failure and compensation for any other reasonable, foreseeable loss or damage. You are also entitled to have the goods repaired or replaced if the goods fail to be of acceptable quality and the failure does not amount to a major failure. Visit the Con-Serv website www.con-serv.com.au/warranty for our detailed warranty policy.

BATHROOMS

BATHROOM ACCESSORIES

Modena Collection.....	6
Comfort Collection.....	8
Bathroom Baskets.....	11

SHOWERS

Overhead Showers.....	13
Paddington.....	13
Streamjet™.....	14
Streamjet™ XL.....	15
Cosmic.....	16
Quewb.....	18
Rainstorm.....	20
Tamper and Vandal Resistant Showers.....	21
Handheld Showers.....	22
Comfort Rail.....	22
Crystal Rail.....	23
Wall Outlet Bracket.....	24
For Rails Only.....	25
Polar Rail.....	26
Riviera Rail.....	27
Antonio Rail.....	28
Quewb Rail.....	29
Combination Showers.....	30
Twin Waters™.....	30

SPARE PARTS

Elbows and Brackets.....	32
Rails and Flanges.....	33
Shower Arms.....	34
Sliders and Accessories.....	35
Shower Handpieces.....	36
Shower Hoses.....	38
Shower Hose Parts.....	39
Switchcock Valve.....	39
Hose Restrictor Bracket.....	39
Hob Mount Set.....	39

FLOW CONTROL

Aerators.....	42
Flow Valves.....	45
Control Valves, Regulators and Spigots.....	45
Dual Check/Non-Return Valves.....	46
Flood Stop Valves.....	46
Meter-Beater® Tap Components.....	47
Measuring Devices.....	47

SAFE-ASSIST HEALTHCARE

Anti-Ligature Collection.....	50
Anti-Ligature Grab Rails.....	50
Anti-Ligature Shower Kits.....	51
Antimicrobial Collection.....	52
Backrests - Accessible Toilet Assist.....	54
Bariatric Collection.....	56
Bariatric Grab Rails.....	56
Bariatric Shower Kits.....	58
Bariatric Shower Seat.....	59
Bariatric Tiltlock®.....	59
Clam® Flange Collection.....	60
Clam® Flange Grab Rails.....	60
Clam® Flange Shower Kits.....	63
Hygienic Seal® Collection.....	66
Hygienic Seal® Grab Rails.....	66
Hygienic Seal® Shower Kits.....	72
Linear Collection.....	80
Linear Grab Rails.....	80
Linear Shower Kits.....	82
Linear Twin Waters™.....	84
Shower Seats.....	88
Folding, Swing and Floor/Wall Grab Rails.....	90
Tiltlock® Folding Grab Rails.....	90
Swinglock® Grab Rails.....	91
Floor/Wall Mounted Grab Rail.....	91
Lift-N-Lock™ Grab Rail.....	91
Spare Parts and Accessories.....	92
Grab Rail Accessories.....	92
Mounting Systems.....	93
Hose Restrictor Bracket.....	94
Sliders and Accessories.....	94
Rails with Sliders.....	95
Shower Kits.....	96
AS 1428.1:2021 Combination Kits.....	102
Accessible Sanitary Facilities.....	102
Accessible Shower Recess.....	104
Accessible Combined Sanitary Facilities.....	106
Ambulant Accessible Compartments.....	108

TECHNICAL INFORMATION

Care and Maintenance.....	111
Certification and Licencing.....	112
Symbols.....	113
Index.....	114
Terms and Conditions.....	122



About Con-Serv

The Con-Serv story began in 1979, when our founding director Gary Harland pioneered a water efficient shower head, that could withstand the harsh Australian environment, and conserve Australia's most valuable liquid asset... water. Although he didn't realise it at the time, Gary had developed something that would be seen as the foundation for today's WELS scheme.

In 1982, Gary incorporated the company to trade as Con-Serv Corporation Australia Pty Ltd, and diversified to better service the plumbing and construction industries introducing bathroom accessories, healthcare and plumbing products. By 1986, Con-Serv had enough production capacity to start distributing products throughout Australia. This is when Con-Serv truly became a widely adopted brand by architects, plumbers and renovators.

Today, the range is as strong as ever consisting of over 2,500 products across three different categories. Con-Serv continue to lead the industry with innovative solutions that push boundaries without compromising the values of quality, efficiency and sustainability we were founded on. Con-Serv have no plans on slowing down and are excited to introduce new products in our 2022 Retail Price Catalogue which include new and extended product ranges, and a wider selection of sizes and finishes.

Bathroom Accessories

Con-Serv Bathroom Accessories are second to none offering superior style, quality and functionality.

Good storage and well-placed bathroom accessories are a must in every bathroom helping to remove clutter from prime real estate areas such as counter tops and shower recess areas. Here are a few tips to help with your next purchase.

Towel Rails Ensure you have the correct size towel rail for the number of towels you hang. This will help them dry faster too!

Bathroom Shelves Perfect in the shower, or above the vanity. Keeping everyday items at arm's length will help speed up your time in the bathroom, and free up your counter top.

Bathroom Baskets Super handy for storing items of all shapes and sizes, Con-Serv have a range of sizes for flexible options that will adapt to your needs.

Robe Hooks Apart from the obvious, this versatile accessory can be used to hold additional towels, clothes, appliances – just about anything!

[See our full range of Bathroom Accessories pages 6-12.](#)

Overhead Showers

From modern minimalist designs to vandal proof functionality, our overhead shower range offers a selection of shower arms that can be combined with any of our water saving shower heads to create the perfect overhead shower for your lifestyle.

Ceiling Showers

Our ceiling shower range offers both striking geometric forms and traditional shower designs featuring the best in water conservation technology. Choose from our Cosmic, Quewb and new Rainstorm shower heads.

Wall Showers

Con-Serv has perfected water saving technology to provide you with its diverse collection of fixed wall showers designed to complement our extensive selection of shower arms. Choose from our Paddington, Streamjet™ and Streamjet™ XL shower heads.

Tamper Proof Showers

Our vandal and tamper proof showers have been developed to enhance safety and security in commercial and public bathrooms. Manufactured with heavy-duty materials, our range is available in WELS 3 Star 9L/min and 4 Star 6.5L/min options.

[See our full range of Overhead Showers pages 13-21.](#)

Handheld Showers

A soothing water odyssey is yours with Con-Serv handheld showers. Minimalist beauty and high performance come together to create a variety of contemporary showers offering total rejuvenation while utilising the best in water conservation technology.

Mix and match Con-Serv showering components to create your customised showering experience. Choose from slide rails with easy to adjust friction sliders that accommodate various heights, and standard wall mounting brackets for a more traditional, minimalist handheld shower.

Select your handpiece from our Breeze, Streamjet™, Streamjet™ Turbo, Streamjet™ XL, Streamjet™ XL Turbo or Princess handpieces which are all WELS 3 Star 9L/min. Our Streamjet™ handpiece is also available in a 4 Star 6.5L/min option.

Con-Serv's collection of handheld showers are available in a variety of finishes* including Brushed Nickel, Chrome, Matte Black or White. All Con-Serv handheld showers include a dual check/non-return valve for protection against backflow contamination.

See our full range of Handheld Showers pages 22-29.

*Not all finishes are available in every range.



Twin Waters™ - Combination Showers

Enjoy the best of both worlds with our dual outlet Twin Waters™ shower system that combines traditional overhead shower luxury with the flexibility of a handheld shower.

Connection options support installation for both top and bottom inlets allowing you to easily convert your bath or shower into a combination shower that will enhance any bathroom.

Available with our Cosmic or Quewb overhead shower rose, you can select your handpiece from our Breeze, Streamjet™, Streamjet™ Turbo, Streamjet™ XL, Streamjet™ XL Turbo or Princess which are all WELS 3 Star 9L/min. Our Streamjet™ handpiece is also available in a 4 Star 6.5L/min option.

See our full range of Twin Waters™ Combination Showers pages 30-31.



Spare Parts

Genuine Parts

We are proud of the Con-Serv range and we design every part that goes into our product. Whether you are renovating, installing, or repairing your bathroom, we have the authentic accessory or part to do the job.

See our full range of genuine Spare Parts pages 32-39.

Quality Guaranteed







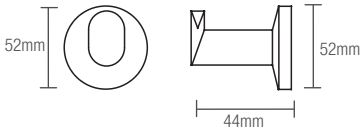

All Con-Serv products are covered by our 20 year domestic or 7 year commercial warranty. Should you need more information about our warranty, contact our team on (07) 3630 5744 or visit our website www.con-serv.com.au/warranty.

BATHROOMS

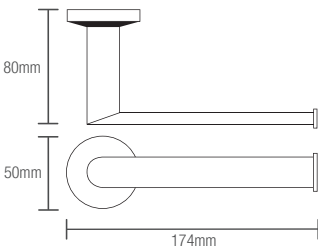
Bathroom Accessories.....	6	Handheld Showers	22
Modena Collection	6	Comfort Rail	22
Comfort Collection	8	Crystal Rail	23
Bathroom Baskets.....	11	Wall Outlet Bracket	24
Overhead Showers	13	For Rails Only	25
Paddington	13	Polar Rail	26
Streamjet™	14	Riviera Rail	27
Streamjet™ XL	15	Antonio Rail	28
Cosmic	16	Quewb Rail	29
Quewb	18	Combination Showers	30
Rainstorm.....	20	Twin Waters™	30
Tamper and Vandal Resistant Showers	21	Spare Parts	32

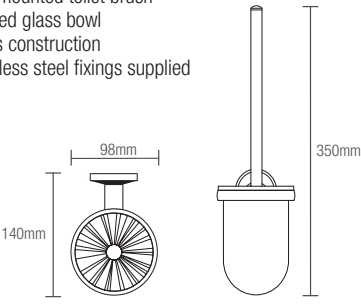

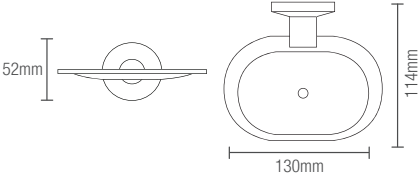

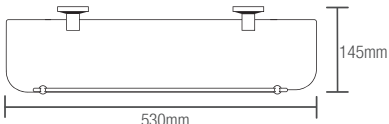

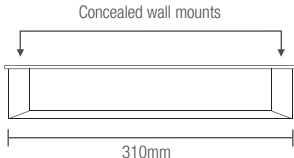

BATHROOM ACCESSORIES MODENA COLLECTION

Quality accessories combining modern materials with classic design elements to create a stylish and sleek finish that will bring your bathroom to life. It is a popular choice amongst interior designers due to the high quality brass construction and timeless chrome finish.

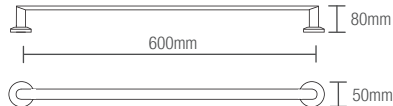
	Code	Finish	Without GST	With GST	Features	
MODENA ROBE HOOK SINGLE						
	BA 115 C	Chrome	34.00	37.40	<ul style="list-style-type: none"> • Brass construction • Stainless steel fixings supplied 	
MODENA TOILET PAPER HOLDER						
	BA 112 C	Chrome	45.00	49.50	<ul style="list-style-type: none"> • Brass construction • Stainless steel fixings supplied 	
MODENA TOILET BRUSH WITH HOLDER						
	BA 114 C	Chrome	90.00	99.00	<ul style="list-style-type: none"> • Wall mounted toilet brush • Frosted glass bowl • Brass construction • Stainless steel fixings supplied 	
	SPARE PARTS					
	BA 714 FR GO	Glass only	21.00	23.10		
	BA 714 WT BO	Brush head only	10.00	11.00		
	BA 714 C BH	Handle only	25.00	27.50		
MODENA SOAP DISH HOLDER						
	BA 101 C	Chrome	70.00	77.00	<ul style="list-style-type: none"> • Brass construction • Stainless steel fixings supplied 	
MODENA GLASS SHELF						
	BA 108 C	Chrome	96.00	105.60	<ul style="list-style-type: none"> • 530mm shelf with barrier • 10mm clear tempered glass • Brass construction • Stainless steel fixings supplied 	
	SPARE PARTS					
	BA 729 C B0	Barrier only	26.00	28.60		



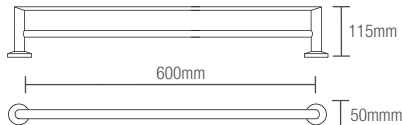

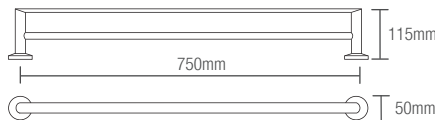

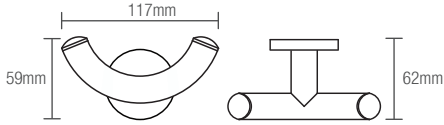

BATHROOM ACCESSORIES MODENA COLLECTION

Quality accessories combining modern materials with classic design elements to create a stylish and sleek finish that will bring your bathroom to life. It is a popular choice amongst interior designers due to the high quality brass construction and timeless chrome finish.

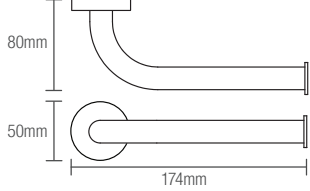
	Code	Finish	Without GST	With GST	Features
MODENA HAND TOWEL RAIL					
	BA 111 C	Chrome	75.00	82.50	<ul style="list-style-type: none"> • 280mm, centre to centre • Brass construction • Stainless steel fixings supplied 
MODENA TOWEL RAIL SINGLE 600MM					
	BA 104 C	Chrome	90.00	99.00	<ul style="list-style-type: none"> • 600mm, centre to centre • Brass construction • Stainless steel fixings supplied 
MODENA TOWEL RAIL SINGLE 750MM					
	BA 105 C	Chrome	120.00	132.00	<ul style="list-style-type: none"> • 750mm, centre to centre • Brass construction • Stainless steel fixings supplied 
MODENA TOWEL RAIL DOUBLE 600MM					
	BA 106 C	Chrome	128.00	140.80	<ul style="list-style-type: none"> • 600mm, centre to centre • Brass construction • Stainless steel fixings supplied 
MODENA TOWEL RAIL DOUBLE 750MM					
	BA 107 C	Chrome	160.00	176.00	<ul style="list-style-type: none"> • 750mm, centre to centre • Brass construction • Stainless steel fixings supplied 

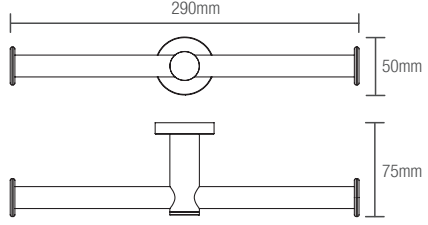

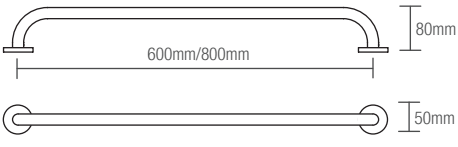

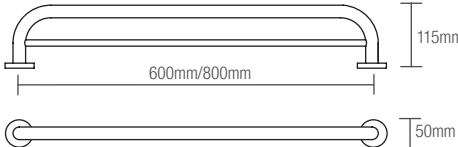

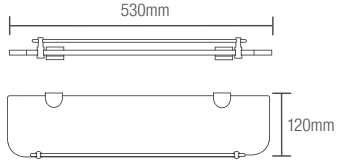

BATHROOM ACCESSORIES COMFORT COLLECTION

Our most popular range, the Comfort Collection features sleek European designs that will stand the test of time. Simple geometric forms with rounded edges enhance the aesthetics while ensuring safety. This comprehensive range is crafted from quality materials for long-lasting looks and durability.

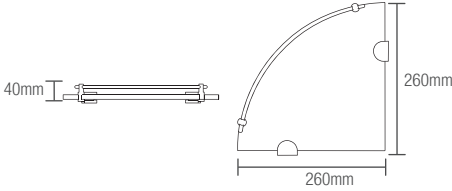
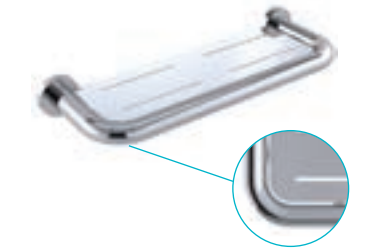
	Code	Finish	Without GST	With GST	Features
COMFORT ROBE HOOK DOUBLE					
	BA 715 BN	Brushed Nickel	65.00	71.50	<ul style="list-style-type: none"> • Brass construction • Stainless steel fixings supplied 
	BA 715 C	Chrome	46.00	50.60	
	BA 715 MB	Matte Black	70.00	77.00	
COMFORT TOILET PAPER HOLDER					
	BA 712 BN	Brushed Nickel	60.00	66.00	<ul style="list-style-type: none"> • Brass construction • Stainless steel fixings supplied 
	BA 712 C	Chrome	40.00	44.00	
	BA 712 MB	Matte Black	65.00	71.50	
COMFORT TOILET PAPER HOLDER DOUBLE					
	BA 722 C	Chrome	66.00	72.60	<ul style="list-style-type: none"> • Brass construction • Stainless steel fixings supplied 
COMFORT TOWEL RAIL SINGLE					
	600MM				<ul style="list-style-type: none"> • 600mm and 800mm, centre to centre, 20mm rail • Brass construction • Stainless steel fixings supplied 
	BA 704 C	Chrome	91.00	100.10	
	800MM				
	BA 705 C	Chrome	105.00	115.50	
COMFORT TOWEL RAIL DOUBLE					
	600MM				<ul style="list-style-type: none"> • 600mm and 800mm, centre to centre, 20mm rail • Brass construction • Stainless steel fixings supplied 
	BA 706 C	Chrome	115.00	126.50	
	800MM				
	BA 707 C	Chrome	140.00	154.00	

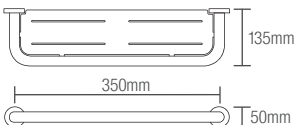
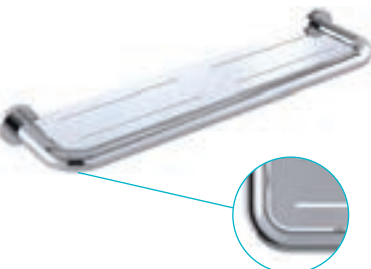
BATHROOM ACCESSORIES COMFORT COLLECTION

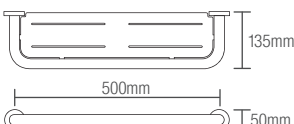

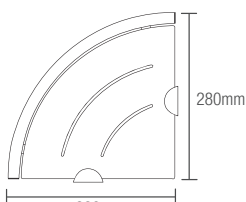



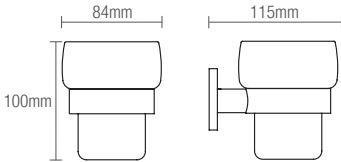

Our most popular range, the Comfort Collection features sleek European designs that will stand the test of time. Simple geometric forms with rounded edges enhance the aesthetics while ensuring safety. This comprehensive range is crafted from quality materials for long-lasting looks and durability.

	Code	Finish	Without GST	With GST	Features	
COMFORT GLASS SHELF						
	BA 729 C	Chrome	95.00	104.50	<ul style="list-style-type: none"> • 530mm shelf with barrier • 10mm clear tempered glass • Brass construction • Stainless steel fixings supplied 	
	SPARE PARTS					
	BA 729 C B0	Barrier only	26.00	28.60		
	BA 769 C	Mount brackets (2)	35.00	38.50		
COMFORT CORNER GLASS SHELF						
	BA 739 C	Chrome	95.00	104.50	<ul style="list-style-type: none"> • 260mm x 260mm shelf with barrier • 10mm clear tempered glass • Brass construction • Stainless steel fixings supplied 	
	SPARE PARTS					
	BA 739 C B0	Barrier only	26.00	28.60		
	BA 769 C	Mount brackets (2)	35.00	38.50		
COMFORT STAINLESS STEEL SHELF 350MM						
	BA 710 BS	Brushed Stainless	165.00	181.50	<ul style="list-style-type: none"> • 350mm, centre to centre • Stainless steel construction • Stainless steel fixings supplied • Complies with requirements of AS 1428.1:2021 section 12.4.2 (B1) Shelves within circulation space  	
	BA 710 MB	Matte Black	210.00	231.00		
	BA 710 PS	Polish Supreme™	175.00	192.50		
COMFORT CORNER STAINLESS STEEL SHELF 500MM						
	BA 708 BS	Brushed Stainless	170.00	187.00	<ul style="list-style-type: none"> • 500mm, centre to centre • Stainless steel construction • Stainless steel fixings supplied • Complies with requirements of AS 1428.1:2021 section 12.4.2 (B2) Shelves external to circulation space  	
	BA 708 MB	Matte Black	220.00	242.00		
	BA 708 PS	Polish Supreme™	185.00	203.50		
COMFORT CORNER STAINLESS STEEL SHELF						
	BA 718 BS	Brushed Stainless	125.00	137.50	<ul style="list-style-type: none"> • 280mm x 280mm radius • Stainless steel construction • Floating mount brackets • Stainless steel fixings supplied 	
	BA 718 PS	Polish Supreme™	140.00	154.00		

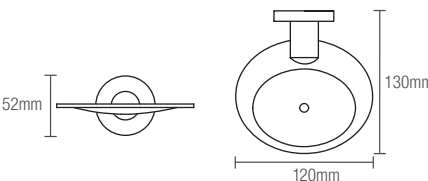
Rounded Safety Edge

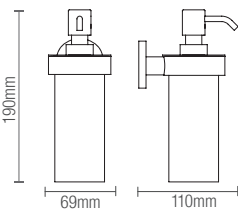
BATHROOM ACCESSORIES COMFORT COLLECTION

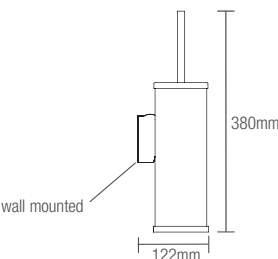
Our most popular range, the Comfort Collection features sleek European designs that will stand the test of time. Simple geometric forms with rounded edges enhance the aesthetics while ensuring safety. This comprehensive range is crafted from quality materials for long-lasting looks and durability.

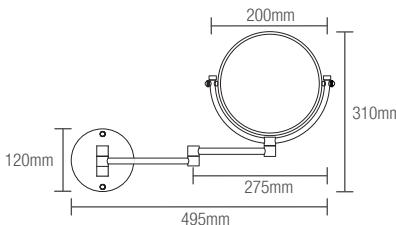
	Code	Finish	Without GST	With GST	Features	
COMFORT TUMBLER HOLDER						
	BA 700 C	Chrome	30.00	33.00	<ul style="list-style-type: none"> • Wall mounted tumbler holder • Frosted glass tumbler • Brass construction • Stainless steel fixings supplied 	
	SPARE PART					
	BA 700 FR GO	Glass only	14.00	15.40		
COMFORT SOAP DISH HOLDER						
	BA 701 C	Chrome	65.00	71.50	<ul style="list-style-type: none"> • Brass construction • Stainless steel fixings supplied 	
COMFORT WALL MOUNTED SOAP HOLDER						
	BA 742 C	Chrome	140.00	154.00	<ul style="list-style-type: none"> • Brass construction • Stainless steel fixings supplied 	
COMFORT WALL MOUNTED TOILET BRUSH WITH HOLDER						
	BA 750 C	Chrome	130.00	143.00	<ul style="list-style-type: none"> • Brass construction • Stainless steel fixings supplied 	
COMFORT MIRROR DUAL SIDED						
	BA 780 C	Chrome	125.00	137.50	<ul style="list-style-type: none"> • Wall mounted with double swivel arm • Normal and 3x magnification • Brass construction • Stainless steel fixings supplied 	

BATHROOM ACCESSORIES COMFORT COLLECTION









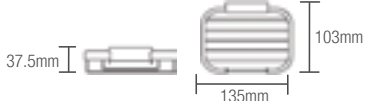

Our most popular range, the Comfort Collection features sleek European designs that will stand the test of time. Simple geometric forms with rounded edges enhance the aesthetics while ensuring safety. This comprehensive range is crafted from quality materials for long-lasting looks and durability.

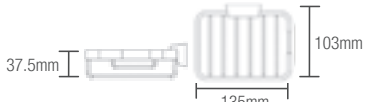
	Code	Finish	Without GST	With GST	Features
COMFORT LIFESTYLE RAIL					
	300MM				<ul style="list-style-type: none"> • Straight support rail • Constructed from 25mm stainless steel for enhanced support • Mount vertically or horizontally • Concealed fixings • Stainless steel fixing screws supplied • Available in 300mm, 450mm, 600mm and 900mm rails • Custom finishes available P.O.A.
	CR 300 BS	Brushed Stainless	100.00	110.00	
	CR 300 MB	Matte Black	140.00	154.00	
	CR 300 PS	Polish Supreme™	105.00	115.50	
	450MM				
	CR 450 BS	Brushed Stainless	110.00	121.00	
	CR 450 MB	Matte Black	150.00	165.00	
	CR 450 PS	Polish Supreme™	115.00	126.50	
	600MM				
	CR 600 BS	Brushed Stainless	120.00	132.00	
	CR 600 MB	Matte Black	160.00	176.00	
	CR 600 PS	Polish Supreme™	130.00	143.00	
	900MM				
CR 900 BS	Brushed Stainless	135.00	148.50		
CR 900 MB	Matte Black	170.00	187.00		
CR 900 PS	Polish Supreme™	150.00	165.00		
COMFORT SHOWER FOOTREST					
	BA 719 C	Chrome	40.00	44.00	<ul style="list-style-type: none"> • Polycarbonate/ABS corner footrest • Concealed fixings • Must be fitted to a solid wall • 1½" x 10G stainless steel screws and wall plugs supplied • Max. 70kg load bearing
COMFORT CLOTHES LINE RETRACTABLE					
	BA 782 C	Chrome	45.00	49.50	<ul style="list-style-type: none"> • 2500mm (maximum) retractable cord extension • Brass construction • Stainless steel fixings supplied
COMFORT CORNER BASKET LARGE					
	BB 017 C	Chrome	95.00	104.50	<ul style="list-style-type: none"> • Concealed fixings • Stainless steel fixings supplied
	BB 017 MB	Matte Black	120.00	132.00	
COMFORT RECTANGULAR BASKET LARGE					
	BB 011 C	Chrome	110.00	121.00	<ul style="list-style-type: none"> • Concealed fixings • Stainless steel fixings supplied
	BB 011 MB	Matte Black	135.00	148.50	

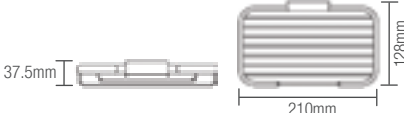
BATHROOM ACCESSORIES

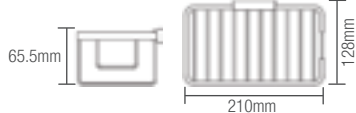
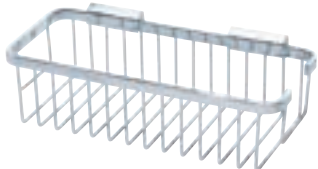
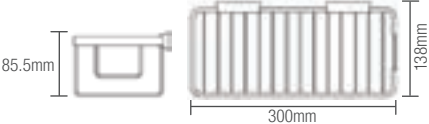
BATHROOM BASKETS

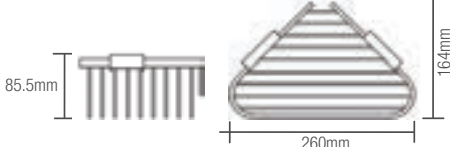
Add some finishing touches to your bathroom with Con-Serv's Bathroom Basket range. Constructed using heavy chrome plated brass, all Con-Serv Bathroom Baskets have innovative concealed fixings and are built to last.

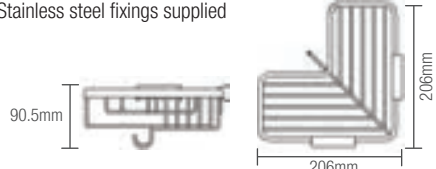
	Code	Finish	Without GST	With GST	Features
RECTANGULAR BASKET SMALL					
	WB 003 C	Chrome	25.00	27.50	<ul style="list-style-type: none"> • Brass construction • Concealed fixings • Stainless steel fixings supplied
					
OPEN FRONT RECTANGULAR BASKET SMALL					
	WB 005 C	Chrome	41.00	45.10	<ul style="list-style-type: none"> • Brass construction • Concealed fixings • Stainless steel fixings supplied
					
OPEN FRONT RECTANGULAR BASKET MEDIUM					
	WB 004 C	Chrome	61.00	67.10	<ul style="list-style-type: none"> • Brass construction • Concealed fixings • Stainless steel fixings supplied
					
RECTANGULAR BASKET MEDIUM					
	WB 002 C	Chrome	70.00	77.00	<ul style="list-style-type: none"> • Brass construction • Concealed fixings • Stainless steel fixings supplied
					
RECTANGULAR BASKET LARGE					
	WB 001 C	Chrome	100.00	110.00	<ul style="list-style-type: none"> • Brass construction • Concealed fixings • Stainless steel fixings supplied
					
CORNER BASKET SMALL					
	WB 008 C	Chrome	84.00	92.40	<ul style="list-style-type: none"> • Brass construction • Concealed fixings • Stainless steel fixings supplied
					
CORNER BASKET MEDIUM					
	WB 006 C	Chrome	100.00	110.00	<ul style="list-style-type: none"> • Brass construction • Concealed fixings • Stainless steel fixings supplied
					

OVERHEAD SHOWERS PADDINGTON

Domed ABS 150mm shower rose with rub-clean diffuser in a traditional single pattern spray. Suited to difficult pressure applications, gravity fed tanks and instantaneous heaters. All Con-Serv Paddington showers are 3 Star 9L/min as per WELS licence number 0046.

	Code	Finish	Without GST	With GST	Features
PADDINGTON ROSE ONLY					
	OH 005A C	Chrome	70.00	77.00	<ul style="list-style-type: none"> • ABS 150mm domed shower rose with rub-clean spray diffuser • Full pattern spray • WaterMark AS 3662 WMKT 21147 • 3 Star 9L/min as per WELS licence number 0046 
PADDINGTON SWAN NECK RISING ARM					
	OH 005E C	Chrome	130.00	143.00	<ul style="list-style-type: none"> • ABS 150mm domed shower rose with rub-clean spray diffuser • Brass 290mm rising arm with flow Interchange® spigot • Brass 57mm wall flange • Full pattern spray • WaterMark AS 3662 WMKT 21147 • 3 Star 9L/min as per WELS licence number 0046 
PADDINGTON HORIZONTAL ARM					
 <div style="position: absolute; top: -40px; left: -40px; border: 2px solid red; border-radius: 50%; padding: 5px; color: white; font-weight: bold;">NEW</div>	OH 005H C	Chrome	150.00	165.00	<ul style="list-style-type: none"> • ABS 150mm domed shower rose with rub-clean spray diffuser • 316 stainless steel 450mm horizontal fixed arm with flow Interchange® spigot • Ball joint mounted • ½" BSP female connection to wall outlet ½" BSP male thread for shower connection • Stainless steel 62mm wall flange • Full pattern spray • WaterMark AS 3662 WMKT 21147 • 3 Star 9L/min as per WELS licence number 0046 
PADDINGTON CLICKLOCK™ ORBITAL/ADJUSTABLE ARM					
 <div style="position: absolute; top: 100px; left: 100px; font-size: 20px;">360°</div>	OH 005D C	Chrome	170.00	187.00	<ul style="list-style-type: none"> • ABS 150mm domed shower rose with rub-clean spray diffuser • Brass 300mm orbital/adjustable arm with flow Interchange® spigot • Brass 57mm wall flange • Full pattern spray • WaterMark AS 3662 WMKT 21147 • 3 Star 9L/min as per WELS licence number 0046 
PADDINGTON VERTICAL ARM					
 <div style="position: absolute; top: 100px; left: 100px; font-size: 12px;"> 150mm/300mm 450mm/600mm </div>	OH 005T C	Chrome 150mm	105.00	115.50	<ul style="list-style-type: none"> • ABS 150mm domed shower rose with rub-clean spray diffuser • Ball joint mounted to 316 stainless steel vertical fixed arm with flow Interchange® spigot • ½" BSP shower connection (Female to Male) • Stainless steel 62mm wall flange • Full pattern spray • WaterMark AS 3662 WMKT 21147 • 3 Star 9L/min as per WELS licence number 0046 • Available in 150mm, 300mm, 450mm and 600mm arms • Custom lengths available on request P.O.A. 
	OH 005U C	Chrome 300mm	115.00	126.50	
	OH 005W C	Chrome 450mm	125.00	137.50	
	OH 005X C	Chrome 600mm	140.00	154.00	



OVERHEAD SHOWERS STREAMJET™

A contemporary ABS 100mm shower rose with concentric single pattern jet spray diffuser producing a rich full pattern spray for a dense shower experience. Streamjet™ overhead showers are available in 3 Star 9L/min and 4 Star 6.5L/min as per WELS licence number 0046.





Code	Finish	Without GST	With GST	Features
------	--------	-------------	----------	----------



STREAMJET™ ROSE ONLY

	OH 006A BN	Brushed Nickel	120.00	132.00	<ul style="list-style-type: none"> • ABS 100mm shower rose with rub-clean spray diffuser • Full pattern spray • WaterMark AS 3662 WMKT 21147 • Available in 3 Star 9L/min and 4 Star 6.5L/min as per WELS licence number 0046 
	OH 006A BN/6.5	Brushed Nickel	120.00	132.00	
	OH 006A C	Chrome	55.00	60.50	
	OH 006A C/6.5	Chrome	55.00	60.50	
	OH 006A MB	Matte Black	100.00	110.00	
	OH 006A MB/6.5	Matte Black	100.00	110.00	
	OH 006A WTC	White/Chrome	60.00	66.00	
	OH 006A WTC/6.5	White/Chrome	60.00	66.00	



STREAMJET™ UPSWEPT FIXED ARM

	OH 006B BN	Brushed Nickel	185.00	203.50	<ul style="list-style-type: none"> • ABS 100mm shower rose with rub-clean spray diffuser • Brass 150mm fixed arm with flow Interchange® spigot • Brass 57mm wall flange • Chrome plated finish • Full pattern spray • WaterMark AS 3662 WMKT 21147 • Available in 3 Star 9L/min and 4 Star 6.5L/min as per WELS licence number 0046 
	OH 006B BN/6.5	Brushed Nickel	185.00	203.50	
	OH 006B C	Chrome	105.00	115.50	
	OH 006B C/6.5	Chrome	105.00	115.50	
	OH 006B MB	Matte Black	165.00	181.50	
	OH 006B MB/6.5	Matte Black	165.00	181.50	
	OH 006B WTC	White/Chrome	120.00	132.00	
	OH 006B WTC/6.5	White/Chrome	120.00	132.00	



STREAMJET™ CLICKLOCK™ ORBITAL/ADJUSTABLE ARM

	OH 006D BN	Brushed Nickel	250.00	275.00	<ul style="list-style-type: none"> • ABS 100mm shower rose with rub-clean spray diffuser • Brass 300mm orbital/adjustable arm with flow Interchange® spigot • Brass 57mm wall flange • Full pattern spray • WaterMark AS 3662 WMKT 21147 • Available in 3 Star 9L/min and 4 Star 6.5L/min as per WELS licence number 0046 
	OH 006D BN/6.5	Brushed Nickel	250.00	275.00	
	OH 006D C	Chrome	155.00	170.50	
	OH 006D C/6.5	Chrome	155.00	170.50	
	OH 006D MB	Matte Black	230.00	253.00	
	OH 006D MB/6.5	Matte Black	230.00	253.00	
	OH 006D WTC	White/Chrome	170.00	187.00	
	OH 006D WTC/6.5	White/Chrome	170.00	187.00	

STREAMJET™ SWAN NECK RISING ARM

	OH 006E BN	Brushed Nickel	215.00	236.50	<ul style="list-style-type: none"> • ABS 100mm shower rose with rub-clean spray diffuser • Brass 290mm rising arm with flow Interchange® spigot • Brass 57mm wall flange • Full pattern spray • WaterMark AS 3662 WMKT 21147 • Available in 3 Star 9L/min and 4 Star 6.5L/min as per WELS licence number 0046 
	OH 006E BN/6.5	Brushed Nickel	215.00	236.50	
	OH 006E C	Chrome	115.00	126.50	
	OH 006E C/6.5	Chrome	115.00	126.50	
	OH 006E MB	Matte Black	195.00	214.50	
	OH 006E MB/6.5	Matte Black	195.00	214.50	
	OH 006E WTC	White/Chrome	135.00	148.50	
	OH 006E WTC/6.5	White/Chrome	135.00	148.50	











STREAMJET™ GRAND ARM

	OH 006G C	Chrome	126.00	138.60	<ul style="list-style-type: none"> • ABS 100mm shower rose with rub-clean spray diffuser • Brass 165mm upswept arm • Full pattern spray • WaterMark AS 3662 WMKT 21147 • Available in 3 Star 9L/min and 4 Star 6.5L/min as per WELS licence number 0046 
	OH 006G C/6.5	Chrome	126.00	138.60	
	OH 006G WTC	White/Chrome	136.00	149.60	
	OH 006G WTC/6.5	White/Chrome	136.00	149.60	

OVERHEAD SHOWERS

STREAMJET™ XL

A premium extra large (XL) ABS 130mm chrome face shower rose with concentric single pattern jet spray producing a lavish rain-like spray for a soothing and relaxing shower. All Con-Serv Streamjet™ XL showers are 3 Star 9L/min as per WELS licence number 0046.

	Code	Finish	Without GST	With GST	Features
STREAMJET™ XL ROSE ONLY					
	OH 008A BN	Brushed Nickel*	150.00	165.00	<ul style="list-style-type: none"> • ABS 130mm extra large shower rose with rub-clean spray diffuser • Full pattern spray • WaterMark AS 3662 WMKT 21147 • 3 Star 9L/min as per WELS licence number 0046 
	OH 008A C	Chrome	75.00	82.50	
	OH 008A MB	Matte Black*	110.00	121.00	
		*AVAILABLE JULY 2022			
STREAMJET™ XL UPSWEPT FIXED ARM					
	OH 008B BN	Brushed Nickel*	215.00	236.50	<ul style="list-style-type: none"> • ABS 130mm extra large shower rose with rub-clean spray diffuser • Brass 150mm fixed arm with flow Interchange® spigot • Brass 57mm wall flange • Chrome plated finish • Full pattern spray • WaterMark AS 3662 WMKT 21147 • 3 Star 9L/min as per WELS licence number 0046 
	OH 008B C	Chrome	125.00	137.50	
	OH 008B MB	Matte Black*	175.00	192.50	
		*AVAILABLE JULY 2022			
STREAMJET™ XL CLICKLOCK™ ORBITAL/ADJUSTABLE ARM					
	OH 008D BN	Brushed Nickel*	280.00	308.00	<ul style="list-style-type: none"> • ABS 130mm extra large shower rose with rub-clean spray diffuser • Brass 300mm orbital/adjustable arm with flow Interchange® spigot • Brass 57mm wall flange • Full pattern spray • WaterMark AS 3662 WMKT 21147 • 3 Star 9L/min as per WELS licence number 0046 
	OH 008D C	Chrome	175.00	192.50	
	OH 008D MB	Matte Black*	240.00	264.00	
		*AVAILABLE JULY 2022			
STREAMJET™ XL SWAN NECK RISING ARM					
	OH 008E BN	Brushed Nickel*	245.00	269.50	<ul style="list-style-type: none"> • ABS 130mm extra large shower rose with rub-clean spray diffuser • Brass 290mm rising arm with flow Interchange® spigot • Brass 57mm wall flange • Full pattern spray • WaterMark AS 3662 WMKT 21147 • 3 Star 9L/min as per WELS licence number 0046 
	OH 008E C	Chrome	135.00	148.50	
	OH 008E MB	Matte Black*	205.00	225.50	
		*AVAILABLE JULY 2022			
STREAMJET™ XL GRAND ARM					
	OH 008G C	Chrome	146.00	160.60	<ul style="list-style-type: none"> • ABS 130mm extra large shower rose with rub-clean spray diffuser • Brass 165mm upswept arm • Full pattern spray • WaterMark AS 3662 WMKT 21147 • 3 Star 9L/min as per WELS licence number 0046 

OVERHEAD SHOWERS COSMIC

Modern ABS 256mm rainmaker shower rose, the Cosmic can be wall or ceiling mounted. Ideal for larger shower areas, with a range of arm options to suit personal style and preferences. All Con-Serv Cosmic showers are 3 Star 9L/min as per WELS licence number 0046.







	Code	Finish	Without GST	With GST	Features	
COSMIC ROSE ONLY						
	OH 028A BN	Brushed Nickel	140.00	154.00	<ul style="list-style-type: none"> • ABS 256mm rainmaker shower rose with rub-clean spray diffuser • Full pattern spray • WaterMark AS 3662 WMKT 21147 • 3 Star 9L/min as per WELS licence number 0046 	
	OH 028A C	Chrome	90.00	99.00		
	OH 028A MB	Matte Black	120.00	132.00		
COSMIC HORIZONTAL ARM 310MM						
	OH 028H C	Chrome	166.00	182.60	<ul style="list-style-type: none"> • ABS 256mm rainmaker shower rose with rub-clean spray diffuser • 310mm fixed arm with flow Interchange® spigot • Brass construction • Brass 57mm wall flange • ½" BSP female inlet with ½" BSP male threaded outlet • Full spray pattern • WaterMark AS 3662 WMKT 21147 • 3 Star 9L/min as per WELS licence number 0046 	
	OH 028H MB	Matte Black	219.00	240.90		
COSMIC HORIZONTAL ARM 450MM						
	OH 028K BN	Brushed Nickel	235.00	258.50	<ul style="list-style-type: none"> • ABS 256mm rainmaker shower rose with rub-clean spray diffuser • 450mm extended projection horizontal arm with flow Interchange® spigot • 316 stainless steel construction for added strength • 316 stainless steel 62mm wall flange • ½" BSP female inlet with ½" BSP male threaded outlet • Full spray pattern • WaterMark AS 3662 WMKT 21147 • 3 Star 9L/min as per WELS licence number 0046 	
	OH 028K C	Chrome	170.00	187.00		
	OH 028K MB	Matte Black	215.00	236.50		
COSMIC SWIVEL CRANE NECK ARM						
	OH 028Q BN	Brushed Nickel	330.00	363.00	<ul style="list-style-type: none"> • ABS 256mm rainmaker shower rose with rub-clean spray diffuser • 380mm crane neck swivelling shower arm with flow Interchange® spigot • Brass construction • Brass 57mm wall flange • ½" BSP female inlet with ½" BSP male threaded outlet • Full spray pattern • WaterMark AS 3662 WMKT 21147 • 3 Star 9L/min as per WELS licence number 0046 	
	OH 028Q C	Chrome	235.00	258.50		
	OH 028Q MB	Matte Black	310.00	341.00		

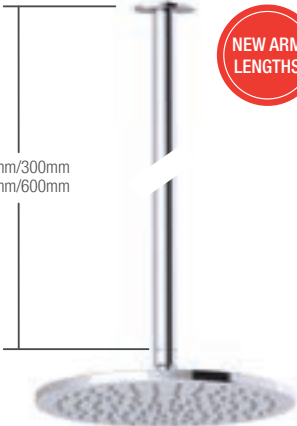

WaterMark
AS/NZS 3662
WMKT 21147

OVERHEAD SHOWERS COSMIC

Modern ABS 256mm rainmaker shower rose, the Cosmic can be wall or ceiling mounted. Ideal for larger shower areas, with a range of arm options to suit personal style and preferences. All Con-Serv Cosmic showers are 3 Star 9L/min as per WELS licence number 0046.

	Code	Finish	Without GST	With GST	Features		
COSMIC VERTICAL ARM							
 <p>150mm/300mm 450mm/600mm</p> <p>NEW ARM LENGTHS</p>	150mm				<ul style="list-style-type: none"> • ABS 256mm rainmaker shower rose with rub-clean spray diffuser • Vertical shower arm for ceiling installations • Available in lengths of 150mm, 300mm, 450mm and 600mm with flow Interchange® spigot • 316 stainless steel construction • 316 stainless steel 62mm wall flange • ½" BSP female inlet with ½" BSP male threaded outlet • Full pattern spray • WaterMark AS 3662 WMKT 21147 • 3 Star 9L/min as per WELS licence number 0046 		
	OH 028T BN	Brushed Nickel	185.00	203.50			
	OH 028T C	Chrome	125.00	137.50			
	OH 028T MB	Matte Black	165.00	181.50			
	300mm						
	OH 028U BN	Brushed Nickel	199.00	218.90			
	OH 028U C	Chrome	135.00	148.50			
	OH 028U MB	Matte Black	179.00	196.90			
	450mm						
	OH 028W BN	Brushed Nickel	212.00	233.20			
	OH 028W C	Chrome	145.00	159.50			
	OH 028W MB	Matte Black	192.00	211.20			
	600mm						
	OH 028X BN	Brushed Nickel	235.00	258.50			
	OH 028X C	Chrome	160.00	176.00			
	OH 028X MB	Matte Black	215.00	236.50			
	COSMIC OVERHEAD RAIL						
	 <p>NEW</p>	OR 080C BN	Brushed Nickel	570.00		627.00	<ul style="list-style-type: none"> • ABS 256mm rainmaker shower rose with rub-clean spray diffuser • 800mm brass rail (TOP INLET) featuring 380mm swivel crane neck arm with flow Interchange® spigot • Brass construction • Brass 57mm wall flange • ½" BSP female inlet with ½" BSP male threaded outlet • Full pattern spray • WaterMark AS 3662 WMKT 21147 • 3 Star 9L/min as per WELS licence number 0046 
OR 080C C		Chrome	430.00	473.00			
OR 080C MB		Matte Black	550.00	605.00			

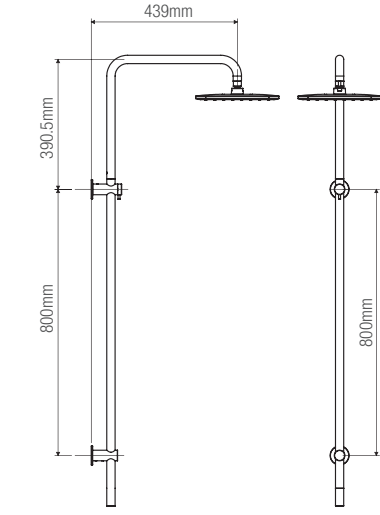







OVERHEAD SHOWERS QUEWB

Stylish ABS 220mm square rainmaker shower rose with rub-clean feature and selected arm options to suit personal preferences. Ideally suited for large shower recess areas. All Con-Serv Quewb showers are 3 Star 9L/min as per WELS licence number 0046.







Code	Finish	Without GST	With GST	Features
------	--------	-------------	----------	----------

QUEWB ROSE ONLY						
	OH 030A C	Chrome	90.00	99.00	<ul style="list-style-type: none"> • ABS 220mm rainmaker shower rose with rub-clean spray diffuser • Full pattern spray • WaterMark AS 3662 WMKT 21147 • 3 Star 9L/min as per WELS licence number 0046 	
QUEWB HORIZONTAL ARM						
	OH 030H C	Chrome	166.00	182.60	<ul style="list-style-type: none"> • ABS 220mm rainmaker shower rose with rub-clean spray diffuser • 310mm fixed arm with flow Interchange® spigot • Brass construction • Brass 57mm wall flange • ½" BSP female inlet with ½" BSP male threaded outlet • Full pattern spray • WaterMark AS 3662 WMKT 21147 • 3 Star 9L/min as per WELS licence number 0046 	
QUEWB SWIVEL CRANE NECK ARM						
	OH 030Q C	Chrome	235.00	258.50	<ul style="list-style-type: none"> • ABS 220mm rainmaker shower rose with rub-clean spray diffuser • 380mm crane neck swivelling shower arm with flow Interchange® spigot • Brass construction • Brass 57mm wall flange • ½" BSP female inlet with ½" BSP male threaded outlet • Full spray pattern • WaterMark AS 3662 WMKT 21147 • 3 Star 9L/min as per WELS licence number 0046 	

OVERHEAD SHOWERS QUEWB

Stylish ABS 220mm square rainmaker shower rose with rub-clean feature and selected arm options to suit personal preferences. Ideally suited for large shower recess areas. All Con-Serv Quewb showers are 3 Star 9L/min as per WELS licence number 0046.

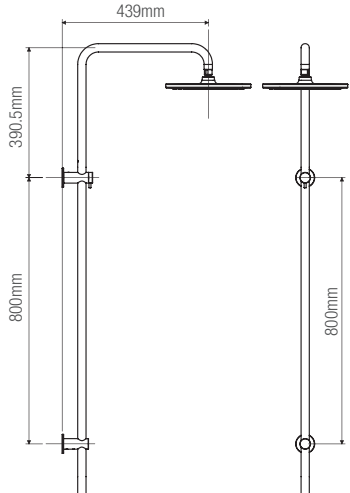
	Code	Finish	Without GST	With GST	Features		
QUEWB VERTICAL ARM							
	150MM				<ul style="list-style-type: none"> • ABS 220mm rainmaker shower rose with rub-clean spray diffuser • Vertical shower arm for ceiling installations • Available in lengths of 150mm, 300mm, 450mm and 600mm • Brass construction • Brass 57mm wall flange • ½" BSP female inlet with ½" BSP male threaded outlet • Full pattern spray • WaterMark AS 3662 WMKT 21147 • 3 Star 9L/min as per WELS licence number 0046 		
	OH 030T C	Chrome	125.00	137.50			
	300MM						
	OH 030U C	Chrome	135.00	148.50			
	450MM						
	OH 030W C	Chrome	145.00	159.50			
	600MM						
	OH 030X C	Chrome	160.00	176.00			
	QUEWB OVERHEAD RAIL						
		OR 080Q C	Chrome	430.00		473.00	<ul style="list-style-type: none"> • ABS 220mm rainmaker shower rose with rub-clean spray diffuser • 800mm brass rail (TOP INLET) featuring 380mm swivel crane neck arm with flow Interchange® spigot • Brass construction • Brass 57mm wall flange • ½" BSP female inlet with ½" BSP male threaded outlet • Full pattern spray • WaterMark AS 3662 WMKT 21147 • 3 Star 9L/min as per WELS licence number 0046  

OVERHEAD SHOWERS RAINSTORM



Generous 250mm rainmaker shower rose manufactured from quality stainless steel. Suited to spacious shower areas, the Rainstorm is ceiling mounted and available in a variety of arm lengths. Rainstorm showers are 3 Star 9L/min as per WELS licence number 0046.



Code	Finish	Without GST	With GST	Features
------	--------	-------------	----------	----------

RAINSTORM ROSE ONLY

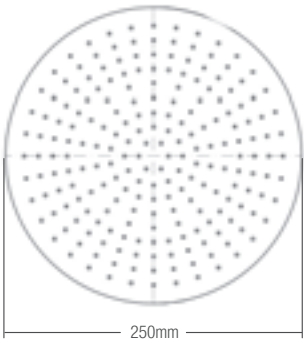
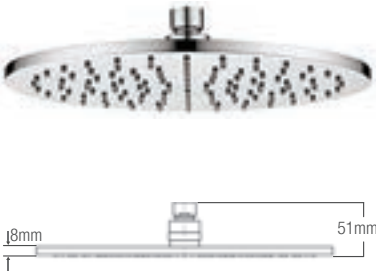

OH 038A BN	Brushed Nickel	180.00	198.00	<ul style="list-style-type: none"> Stainless steel 250mm rainmaker shower rose with rub-clean spray diffuser ½" BSP female connection brass ball joint encased by a nylon ball joint collar for ease of movement and long life Full pattern spray WaterMark AS 3662 WMKT 21147 3 Star 9L/min as per WELS licence number 0046
OH 038A C	Chrome	160.00	176.00	
OH 038A MB	Matte Black	170.00	187.00	



RAINSTORM VERTICAL ARM

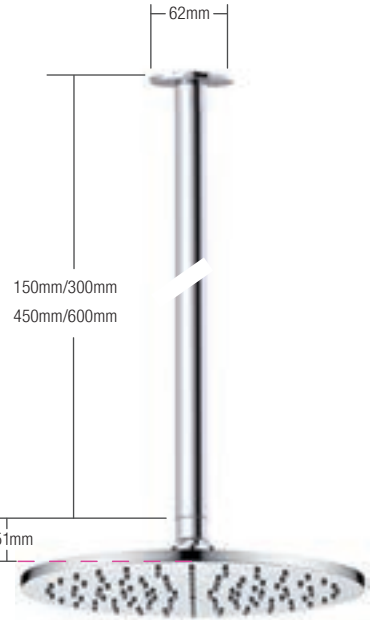

150MM		Without GST	With GST	<ul style="list-style-type: none"> Stainless steel 250mm rainmaker shower rose with rub-clean spray diffuser Brass vertical fixed arm for ceiling installations Available in standard lengths of 150mm, 300mm, 450mm & 600mm Brass 62mm wall flange ½" BSP female inlet with ½" BSP male threaded outlet Full pattern spray WaterMark AS 3662 WMKT 21147 3 Star 9L/min as per WELS licence number 0046
OH 038T BN	Brushed Nickel	225.00	247.50	
OH 038T C	Chrome	195.00	214.50	
OH 038T MB	Matte Black	215.00	236.50	



TAMPER AND VANDAL RESISTANT SHOWERS

PIONEER, ZODIAC, COBRA AND VANGUARD

For installation where vandalism is a consideration such as camping grounds, caravan parks, beaches and schools. All Con-Serv tamper and vandal resistant overhead showers are available in 3 Star 9L/min and 4 Star 6.5L/min as per WELS licence number 0046.

Code	Finish	Without GST	With GST	Features
------	--------	-------------	----------	----------

TAMPER RESISTANT SHOWERS

PIONEER						
	CS 008 C	Chrome	95.00	104.50	<ul style="list-style-type: none"> • Heavy-duty design • Ideal for camp-sites, caravan parks and schools • 125mm shower body with flow Interchange® spigot • Brass construction • Brass 57mm wall flange • 316 stainless steel (marine grade) 27mm jet spray diffuser • Spring tensioned (anti-droop) ball joint • Full pattern spray • WaterMark AS 3662 WMKT 21147 • Available in 3 Star 9L/min and 4 Star 6.5L/min as per WELS licence number 0046 	
	CS 008 C/6.5	Chrome	95.00	104.50		
ZODIAC						
	CS 061 C	Chrome	95.00	104.50	<ul style="list-style-type: none"> • Heavy-duty design • Ideal for camp-sites, caravan parks and schools • ABS 50mm concentric spray diffuser • 55mm arm with flow Interchange® spigot • Brass construction • Brass 57mm wall flange • Full pattern spray • WaterMark AS 3662 WMKT 21147 • 3 Star 9L/min as per WELS licence number 0046 	

VANDAL RESISTANT SHOWERS













COBRA					
	CS 007 C	Chrome	105.00	115.50	<ul style="list-style-type: none"> • Vandal resistant/Anti-ligature design • Ideal for correctional, mental health and rehabilitation centres • 17° angle design, free from ligature points and attached with grub screws for tamper resistant installation • 59mm shower body • Brass construction • 316 stainless steel (marine grade) 27mm jet spray diffuser • Full pattern spray • Maximum spray projection 940mm from 1850mm height • WaterMark AS 3662 WMKT 21147 • Available in 3 Star 9L/min and 4 Star 6.5L/min as per WELS licence number 0046 
	CS 007 C/6.5	Chrome	105.00	115.50	
VANGUARD					
	CS 009 PS	Polish Supreme™	95.00	104.50	<ul style="list-style-type: none"> • Vandal resistant design • Ideal for high corrosion environments e.g. beach fronts • 316 stainless steel (marine grade) 65mm shower body with flow Interchange® spigot • 316 stainless steel 62mm wall flange • 27mm jet spray diffuser • Full pattern spray • WaterMark AS 3662 WMKT 21147 • Available in 3 Star 9L/min and 4 Star 6.5L/min as per WELS licence number 0046 
	CS 009 PS/6.5	Polish Supreme™	95.00	104.50	

HANDHELD SHOWERS - COMFORT RAIL

- 900mm x 25mm stainless steel rail
- 50mm wall mount flange
- Solid brass Friction Slide Cradle
- DR brass wall outlet elbow

- DR brass 9L/min flow Interchange® spigot
- Licenced dual check/non-return valve
- 57mm solid brass round flat flange
- 1500mm PVC hose



Model	Code	Finish	Without GST	With GST	Features	
STREAMJET™						
	CR 900J BN	Brushed Nickel	527.00	579.70	<ul style="list-style-type: none"> • ABS 100mm single function shower • Concentric full pattern spray • Rub-clean spray diffuser • WaterMark AS 3662 WMKT 21147 • Available in 3 Star 9L/min and 4 Star 6.5L/min as per WELS licence number 0046 	
	CR 900J BN/6.5	Brushed Nickel	527.00	579.70		
	CR 900J C	Chrome	420.00	462.00		
	CR 900J C/6.5	Chrome	420.00	462.00		
	CR 900J MB	Matte Black	507.00	557.70		
	CR 900J MB/6.5	Matte Black	507.00	557.70		
STREAMJET™ TURBO PULSATOR						
	CR 900T C	Chrome	450.00	495.00	<ul style="list-style-type: none"> • ABS 100mm multi-function shower • Soft, pulsating and bubble spray functions • Rub-clean spray diffuser • WaterMark AS 3662 WMKT 21147 • Available in 3 Star 9L/min as per WELS licence number 0046 	
STREAMJET™ XL						
	CR 900X BN	Brushed Nickel*	562.00	618.20	<ul style="list-style-type: none"> • ABS 130mm single function shower • Concentric full pattern spray • Rub-clean spray diffuser • WaterMark AS 3662 WMKT 21147 • Available in 3 Star 9L/min as per WELS licence number 0046 	
	CR 900X C	Chrome	445.00	489.50		
	CR 900X MB	Matte Black*	542.00	596.20		
			*AVAILABLE JULY 2022			
STREAMJET™ XL TURBO PULSATOR						
	CR 900S C	Chrome	475.00	522.50	<ul style="list-style-type: none"> • ABS 130mm multi-function shower • Soft, pulsating and bubble spray functions • Rub-clean spray diffuser • WaterMark AS 3662 WMKT 21147 • Available in 3 Star 9L/min as per WELS licence number 0046 	
PRINCESS						
	CR 900P C	Chrome	405.00	445.50	<ul style="list-style-type: none"> • ABS 83mm arched single function shower • Full pattern spray • Rub-clean spray diffuser • WaterMark AS 3662 WMKT 21147 • Available in 3 Star 9L/min as per WELS licence number 0046 	
BREEZE						
	CR 900Z C	Chrome	421.00	463.10	<ul style="list-style-type: none"> • ABS 104mm arched multi-function shower • Soft, pulsating and bubble spray functions • Rub-clean spray diffuser • Available in 3 Star 9L/min as per WELS licence number 0046 	

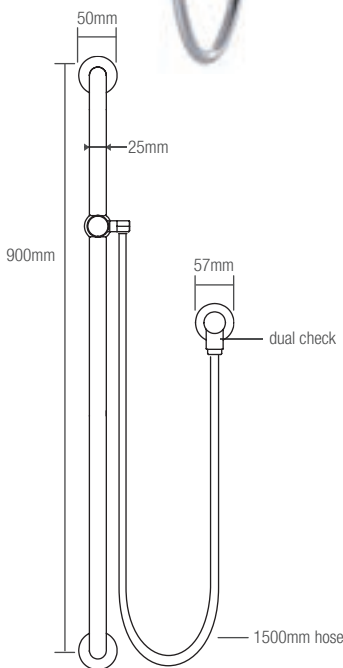









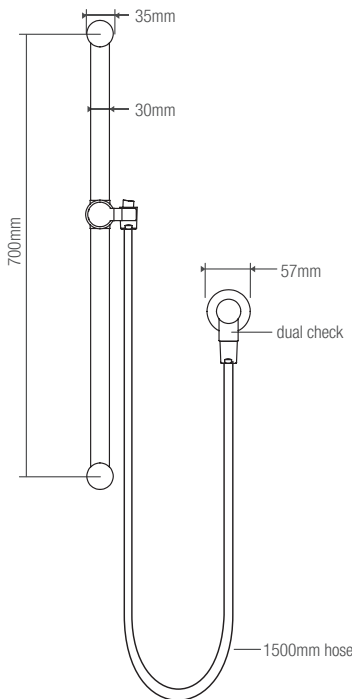



Model shown: CR 900T C

HANDHELD SHOWERS - CRYSTAL RAIL

- 700mm x 30mm brass curved slide rail
- Brass wall mount brackets
- Solid brass Friction Slide Cradle
- DR brass wall outlet elbow

- DR brass 9L/min flow Interchange® spigot
- Licenced dual check/non-return valve
- 57mm solid brass round flat flange
- 1500mm PVC hose



Model	Code	Finish	Without GST	With GST	Features
STREAMJET™					
	HS 010J C	Chrome	300.00	330.00	<ul style="list-style-type: none"> • ABS 100mm single function shower • Concentric full pattern spray • Rub-clean spray diffuser • WaterMark AS 3662 WMKT 21147 • Available in 3 Star 9L/min and 4 Star 6.5L/min as per WELS licence number 0046 
	HS 010J C/6.5	Chrome	300.00	330.00	
	HS 010J WTC	White/Chrome	310.00	341.00	
	HS 010J WTC/6.5	White/Chrome	310.00	341.00	
STREAMJET™ TURBO PULSATOR					
	HS 010T C	Chrome	330.00	363.00	<ul style="list-style-type: none"> • ABS 100mm multi-function shower • Soft, pulsating and bubble spray functions • Rub-clean spray diffuser • WaterMark AS 3662 WMKT 21147 • Available in 3 Star 9L/min as per WELS licence number 0046 
STREAMJET™ XL					
	HS 010X C	Chrome	325.00	357.50	<ul style="list-style-type: none"> • ABS 130mm single function shower • Concentric full pattern spray • Rub-clean spray diffuser • WaterMark AS 3662 WMKT 21147 • Available in 3 Star 9L/min as per WELS licence number 0046 
STREAMJET™ XL TURBO PULSATOR					
	HS 010S C	Chrome	355.00	390.50	<ul style="list-style-type: none"> • ABS 130mm multi-function shower • Soft, pulsating and bubble spray functions • Rub-clean spray diffuser • WaterMark AS 3662 WMKT 21147 • Available in 3 Star 9L/min as per WELS licence number 0046 
PRINCESS					
	HS 010P C	Chrome	285.00	313.50	<ul style="list-style-type: none"> • ABS 83mm arched single function shower • Full pattern spray • Rub-clean spray diffuser • WaterMark AS 3662 WMKT 21147 • Available in 3 Star 9L/min as per WELS licence number 0046 
BREEZE					
	HS 010Z C	Chrome	301.00	331.10	<ul style="list-style-type: none"> • ABS 104mm arched multi-function shower • Soft, pulsating and bubble spray functions • Rub-clean spray diffuser • Available in 3 Star 9L/min as per WELS licence number 0046 



Model shown: HS 010X C

HANDHELD SHOWERS - WALL OUTLET BRACKET

- 85mm DR brass right angled wall outlet bracket
- DR brass 9L/min flow Interchange® spigot

- Licenced dual check/non-return valve
- 57mm solid brass round flat flange
- 1500mm PVC hose



Model	Code	Finish	Without GST	With GST	Features	
STREAMJET™						
	HS 011J BN	Brushed Nickel	320.00	352.00	<ul style="list-style-type: none"> • ABS 100mm single function shower • Concentric full pattern spray • Rub-clean spray diffuser • WaterMark AS 3662 WMKT 21147 • Available in 3 Star 9L/min and 4 Star 6.5L/min as per WELS licence number 0046 	
	HS 011J BN/6.5	Brushed Nickel	320.00	352.00		
	HS 011J C	Chrome	215.00	236.50		
	HS 011J C/6.5	Chrome	215.00	236.50		
	HS 011J MB	Matte Black	280.00	308.00		
	HS 011J MB/6.5	Matte Black	280.00	308.00		
	HS 011J WTC	White/Chrome	205.00	225.50		
	HS 011J WTC/6.5	White/Chrome	205.00	225.50		
STREAMJET™ TURBO PULSATOR						
	HS 011T C	Chrome	245.00	269.50	<ul style="list-style-type: none"> • ABS 100mm multi-function shower • Soft, pulsating and bubble spray functions • Rub-clean spray diffuser • WaterMark AS 3662 WMKT 21147 • Available in 3 Star 9L/min as per WELS licence number 0046 	
STREAMJET™ XL						
	HS 011X BN	Brushed Nickel*	355.00	390.50	<ul style="list-style-type: none"> • ABS 130mm single function shower • Concentric full pattern spray • Rub-clean spray diffuser • WaterMark AS 3662 WMKT 21147 • Available in 3 Star 9L/min as per WELS licence number 0046 	
	HS 011X C	Chrome	240.00	264.00		
	HS 011X MB	Matte Black*	315.00	346.50		
		*AVAILABLE JULY 2022				
STREAMJET™ XL TURBO PULSATOR						
	HS 011S C	Chrome	270.00	297.00	<ul style="list-style-type: none"> • ABS 130mm multi-function shower • Soft, pulsating and bubble spray functions • Rub-clean spray diffuser • WaterMark AS 3662 WMKT 21147 • Available in 3 Star 9L/min as per WELS licence number 0046 	
PRINCESS						
	HS 011P C	Chrome	200.00	220.00	<ul style="list-style-type: none"> • ABS 83mm arched single function shower • Full pattern spray • Rub-clean spray diffuser • WaterMark AS 3662 WMKT 21147 • Available in 3 Star 9L/min as per WELS licence number 0046 	
BREEZE						
	HS 011Z C	Chrome	216.00	237.60	<ul style="list-style-type: none"> • ABS 104mm arched multi-function shower • Soft, pulsating and bubble spray functions • Rub-clean spray diffuser • Available in 3 Star 9L/min as per WELS licence number 0046 	

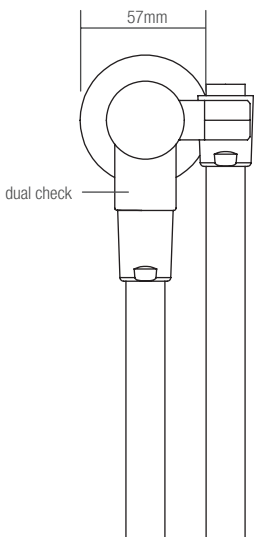

Model shown: HS 011T C

HANDHELD SHOWERS WALL OUTLET BRACKET

HANDHELD SHOWERS - FOR RAILS ONLY

- DR brass wall outlet bracket
- DR brass 9L/min flow Interchange® spigot
- Licenced dual check/non-return valve
- 57mm solid brass round flat flange
- 1500mm PVC hose



**HANDPIECE
SUPPORT NOT
INCLUDED**

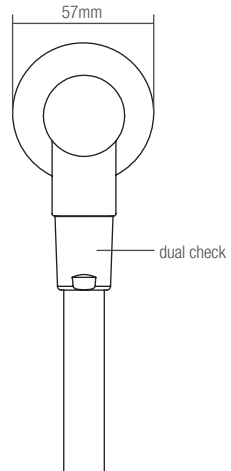

Model	Code	Finish	Without GST	With GST	Features	
STREAMJET™						
	HS 017J BN	Brushed Nickel	262.00	288.20	<ul style="list-style-type: none"> • ABS 100mm single function shower • Concentric full pattern spray • Rub-clean spray diffuser • WaterMark AS 3662 WMKT 21147 • Available in 3 Star 9L/min and 4 Star 6.5L/min as per WELS licence number 0046 	
	HS 017J BN/6.5	Brushed Nickel	262.00	288.20		
	HS 017J C	Chrome	170.00	187.00		
	HS 017J C/6.5	Chrome	170.00	187.00		
	HS 017J MB	Matte Black	222.00	244.20		
	HS 017J MB/6.5	Matte Black	222.00	244.20		
	HS 017J WTC	White/Chrome	166.00	182.60		
	HS 017J WTC/6.5	White/Chrome	166.00	182.60		
STREAMJET™ TURBO PULSATOR						
	HS 017T C	Chrome	200.00	220.00	<ul style="list-style-type: none"> • ABS 100mm multi-function shower • Soft, pulsating and bubble spray functions • Rub-clean spray diffuser • WaterMark AS 3662 WMKT 21147 • Available in 3 Star 9L/min as per WELS licence number 0046 	
STREAMJET™ XL						
	HS 017X BN	Brushed Nickel*	297.00	326.70	<ul style="list-style-type: none"> • ABS 130mm single function shower • Concentric full pattern spray • Rub-clean spray diffuser • WaterMark AS 3662 WMKT 21147 • Available in 3 Star 9L/min as per WELS licence number 0046 	
	HS 017X C	Chrome	195.00	214.50		
	HS 017X MB	Matte Black*	257.00	282.70		
		*AVAILABLE JULY 2022				
STREAMJET™ XL TURBO PULSATOR						
	HS 017S C	Chrome	225.00	247.50	<ul style="list-style-type: none"> • ABS 130mm multi-function shower • Soft, pulsating and bubble spray functions • Rub-clean spray diffuser • WaterMark AS 3662 WMKT 21147 • Available in 3 Star 9L/min as per WELS licence number 0046 	
PRINCESS						
	HS 017P C	Chrome	155.00	170.50	<ul style="list-style-type: none"> • ABS 83mm arched single function shower • Full pattern spray • Rub-clean spray diffuser • WaterMark AS 3662 WMKT 21147 • Available in 3 Star 9L/min as per WELS licence number 0046 	
HOSCARE®						
	HS 017H AC	Antimicrobial Chrome	150.00	165.00	<ul style="list-style-type: none"> • ABS 100mm single function shower with Biomaster antimicrobial additive • Concentric full pattern spray • Rub-clean spray diffuser • WaterMark AS 3662 WMKT 21147 • Available in 3 Star 9L/min as per WELS licence number 0046 	
	HS 017H AW	Antimicrobial White	146.00	160.60		















HANDHELD SHOWERS - POLAR RAIL

- 700mm x 25mm brass round slide rail
- Solid brass Friction Slide Cradle
- Floating brass wall mount brackets
- DR brass wall outlet elbow

- DR brass 9L/min flow Interchange® spigot
- Licenced dual check/non-return valve
- 57mm solid brass round flat flange
- 1500mm PVC hose



Model	Code	Finish	Without GST	With GST	Features	
STREAMJET™						
	HS 020J BN	Brushed Nickel	502.00	552.20	<ul style="list-style-type: none"> • ABS 100mm single function shower • Concentric full pattern spray • Rub-clean spray diffuser • WaterMark AS 3662 WMKT 21147 • Available in 3 Star 9L/min and 4 Star 6.5L/min as per WELS licence number 0046 	
	HS 020J BN/6.5	Brushed Nickel	502.00	552.20		
	HS 020J C	Chrome	365.00	401.50		
	HS 020J C/6.5	Chrome	365.00	401.50		
	HS 020J MB	Matte Black	462.00	508.20		
	HS 020J MB/6.5	Matte Black	462.00	508.20		
STREAMJET™ TURBO PULSATOR						
	HS 020T C	Chrome	395.00	434.50	<ul style="list-style-type: none"> • ABS 100mm multi-function shower • Soft, pulsating and bubble spray functions • Rub-clean spray diffuser • WaterMark AS 3662 WMKT 21147 • Available in 3 Star 9L/min as per WELS licence number 0046 	
STREAMJET™ XL						
	HS 020X BN	Brushed Nickel*	537.00	590.70	<ul style="list-style-type: none"> • ABS 130mm single function shower • Concentric full pattern spray • Rub-clean spray diffuser • WaterMark AS 3662 WMKT 21147 • Available in 3 Star 9L/min as per WELS licence number 0046 	
	HS 020X C	Chrome	390.00	429.00		
	HS 020X MB	Matte Black*	497.00	546.70		
			*AVAILABLE JULY 2022			
STREAMJET™ XL TURBO PULSATOR						
	HS 020S C	Chrome	420.00	462.00	<ul style="list-style-type: none"> • ABS 130mm multi-function shower • Soft, pulsating and bubble spray functions • Rub-clean spray diffuser • WaterMark AS 3662 WMKT 21147 • Available in 3 Star 9L/min as per WELS licence number 0046 	
PRINCESS						
	HS 020P C	Chrome	350.00	385.00	<ul style="list-style-type: none"> • ABS 83mm arched single function shower • Full pattern spray • Rub-clean spray diffuser • WaterMark AS 3662 WMKT 21147 • Available in 3 Star 9L/min as per WELS licence number 0046 	
BREEZE						
	HS 020Z C	Chrome	366.00	402.60	<ul style="list-style-type: none"> • ABS 104mm arched multi-function shower • Soft, pulsating and bubble spray functions • Rub-clean spray diffuser • Available in 3 Star 9L/min as per WELS licence number 0046 	

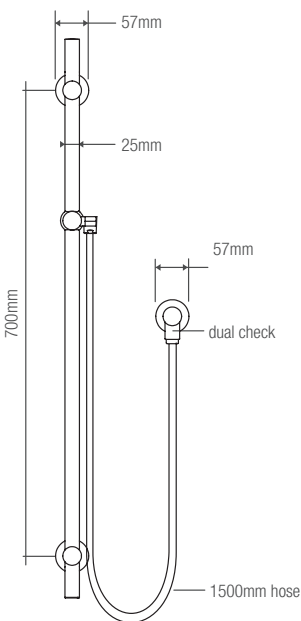



Model shown: HS 020P C

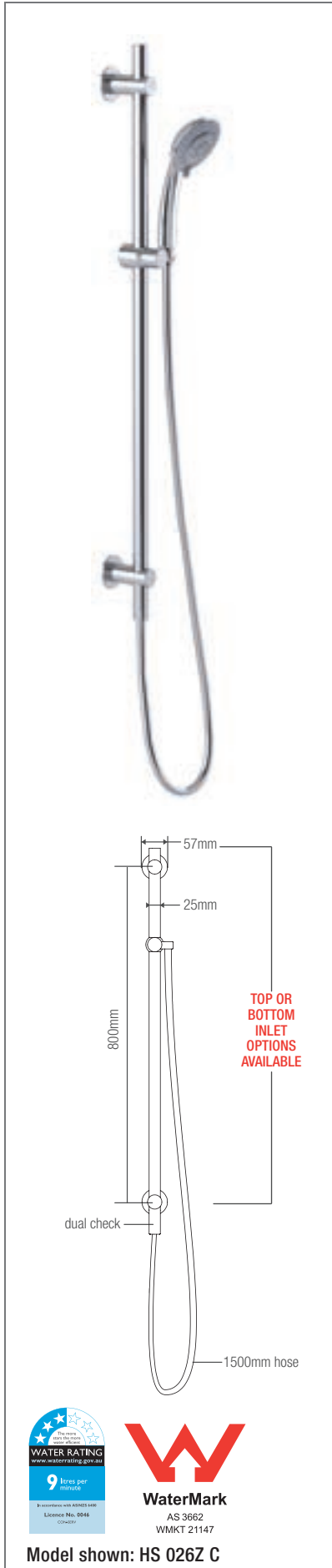

HANDHELD SHOWERS - RIVIERA RAIL



- 800mm x 25mm brass round slide rail
- Solid brass Friction Slide Cradle
- DR brass floating lower mount bracket
- Top mount 9L/min Interchange® spigot
- DR brass flow outlet hose connection
- Licenced dual check/non-return valve
- 57mm solid brass round flat flange
- 1500mm PVC hose







Model	Code	Finish	Without GST	With GST	Features
-------	------	--------	-------------	----------	----------



STREAMJET™						
	TOP INLET					<ul style="list-style-type: none"> • ABS 100mm single function shower • Concentric full pattern spray • Rub-clean spray diffuser • WaterMark AS 3662 WMKT 21147 • Available in 3 Star 9L/min and 4 Star 6.5L/min as per WELS licence number 0046 
	HS 026J BN	Brushed Nickel	545.00	599.50		
	HS 026J BN/6.5	Brushed Nickel	545.00	599.50		
	HS 026J C	Chrome	415.00	456.50		
	HS 026J C/6.5	Chrome	415.00	456.50		
	HS 026J MB	Matte Black	505.00	555.50		
	HS 026J MB/6.5	Matte Black	505.00	555.50		
	BOTTOM INLET					
	HS 036J BN	Brushed Nickel	590.00	649.00		
	HS 036J BN/6.5	Brushed Nickel	590.00	649.00		
HS 036J C	Chrome	460.00	506.00			
HS 036J C/6.5	Chrome	460.00	506.00			
HS 036J MB	Matte Black	550.00	605.00			
HS 036J MB/6.5	Matte Black	550.00	605.00			

STREAMJET™ TURBO PULSATOR						
	TOP INLET					<ul style="list-style-type: none"> • ABS 100mm multi-function shower • Soft, pulsating & bubble spray • WaterMark AS 3662 WMKT 21147 • Available in 3 Star 9L/min as per WELS licence number 0046 
	HS 026T C	Chrome	445.00	489.50		
	BOTTOM INLET					
	HS 036T C	Chrome	490.00	539.00		

STREAMJET™ XL						
	TOP INLET					<ul style="list-style-type: none"> • ABS 130mm single function shower • Concentric full pattern spray • Rub-clean spray diffuser • WaterMark AS 3662 WMKT 21147 • Available in 3 Star 9L/min as per WELS licence number 0046 
	HS 026X BN	Brushed Nickel*	580.00	638.00		
	HS 026X C	Chrome	440.00	484.00		
	HS 026X MB	Matte Black*	540.00	594.00		
	BOTTOM INLET					
	HS 036X BN	Brushed Nickel*	625.00	687.50		
HS 036X C	Chrome	485.00	533.50			
HS 036X MB	Matte Black*	585.00	643.50		*AVAILABLE JULY 2022	

STREAMJET™ XL TURBO PULSATOR						
	TOP INLET					<ul style="list-style-type: none"> • ABS 130mm multi-function shower • Soft, pulsating and bubble spray • WaterMark AS 3662 WMKT 21147 • Available in 3 Star 9L/min as per WELS licence number 0046 
	HS 026S C	Chrome	470.00	517.00		
	BOTTOM INLET					
	HS 036S C	Chrome	515.00	566.50		

PRINCESS						
	TOP INLET					<ul style="list-style-type: none"> • ABS 83mm arched shower • Single function, full pattern spray • WaterMark AS 3662 WMKT 21147 • Available in 3 Star 9L/min as per WELS licence number 0046 
	HS 026P C	Chrome	400.00	440.00		
	BOTTOM INLET					
	HS 036P C	Chrome	445.00	489.50		

BREEZE						
	TOP INLET					<ul style="list-style-type: none"> • ABS 104mm arched shower • Multi-function soft, pulsating and bubble spray • Available in 3 Star 9L/min as per WELS licence number 0046 
	HS 026Z C	Chrome	466.00	512.60		
	BOTTOM INLET					
	HS 036Z C	Chrome	511.00	562.10		













Model shown: HS 026Z C

HANDHELD SHOWERS - ANTONIO RAIL

- 700mm x 22mm tubular rail
- ABS adjustable slide cradle
- DR brass wall outlet elbow
- DR brass 9L/min flow Interchange® spigot

- Licenced dual check/non-return valve
- 57mm solid brass round flat flange
- 1500mm PVC hose



Model	Code	Finish	Without GST	With GST	Features
STREAMJET™					
	HS 030J C	Chrome	215.00	236.50	<ul style="list-style-type: none"> • ABS 100mm single function shower • Concentric full pattern spray • Rub-clean spray diffuser • WaterMark AS 3662 WMKT 21147 • Available in 3 Star 9L/min and 4 Star 6.5L/min as per WELS licence number 0046 
	HS 030J C/6.5	Chrome	215.00	236.50	
STREAMJET™ TURBO PULSATOR					
	HS 030T C	Chrome	245.00	269.50	<ul style="list-style-type: none"> • ABS 100mm multi-function shower • Soft, pulsating and bubble spray functions • Rub-clean spray diffuser • WaterMark AS 3662 WMKT 21147 • Available in 3 Star 9L/min as per WELS licence number 0046 
STREAMJET™ XL					
	HS 030X C	Chrome	240.00	264.00	<ul style="list-style-type: none"> • ABS 130mm single function shower • Concentric full pattern spray • Rub-clean spray diffuser • WaterMark AS 3662 WMKT 21147 • Available in 3 Star 9L/min as per WELS licence number 0046 
STREAMJET™ XL TURBO PULSATOR					
	HS 030S C	Chrome	270.00	297.00	<ul style="list-style-type: none"> • ABS 130mm multi-function shower • Soft, pulsating and bubble spray functions • Rub-clean spray diffuser • WaterMark AS 3662 WMKT 21147 • Available in 3 Star 9L/min as per WELS licence number 0046 
PRINCESS					
	HS 030P C	Chrome	200.00	220.00	<ul style="list-style-type: none"> • ABS 83mm arched single function shower • Full pattern spray • Rub-clean spray diffuser • WaterMark AS 3662 WMKT 21147 • Available in 3 Star 9L/min as per WELS licence number 0046 
BREEZE					
	HS 030Z C	Chrome	216.00	237.60	<ul style="list-style-type: none"> • ABS 104mm arched multi-function shower • Soft, pulsating and bubble spray functions • Rub-clean spray diffuser • Available in 3 Star 9L/min as per WELS licence number 0046 

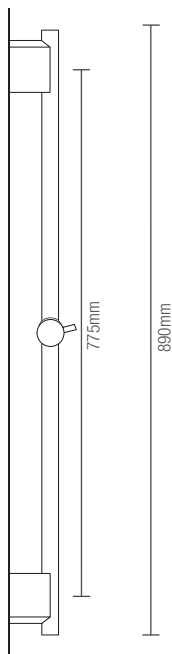





Model shown: HS 030J C

HANDHELD AND COMBINATION SHOWERS

QUEWB

Contemporary square design combining minimalist beauty and bold square edge profiles. The Quewb offers a full body spray with rub-clean features. All Con-Serv Quewb showers are 3 Star 9L/min as per WELS licence number 0046.

	Code	Finish	Without GST	With GST	Features	
QUEWB SLIDE RAIL						
	HS 010U C	Chrome	260.00	286.00	<ul style="list-style-type: none"> • Brass 700mm square edge slide track • Brass square edge friction slide cradle • ABS square single function shower rose with rub-clean spray diffuser • PVC 1500mm Silverflex™ hose with ½" BSP swivel conical end nut • DR brass square edge wall outlet elbow with flow Interchange® spigot • Licenced dual check/non-return valve • Brass 57mm square wall flange • WaterMark AS/NZS 3662 WMKT 21147 • Licenced dual check/non-return as per WaterMark AS/NZS 2845.1 WMKA 02696 • 3 Star 9L/min as per WELS licence number 0046 	
QUEWB TWIN WATERS™						
	TOP INLET				<ul style="list-style-type: none"> • ABS 220mm rainmaker overhead shower rose with rub-clean spray diffuser • ABS square single function handheld shower with rub-clean spray diffuser 	
	TW 029QU C	Chrome	650.00	715.00		
	BOTTOM INLET				<ul style="list-style-type: none"> • Brass 800mm rail and brackets with adjustable lower bracket • Brass 380mm swivel crane arm • Brass 19mm female inlet diverter switchcock valve with flow Interchange® spigot • Brass friction slide cradle for handset support and height adjustment • PVC 1500mm Silverflex™ hose with ½" BSP swivel conical end nut • Brass 57mm square wall flanges • Stainless steel fixings supplied • Full pattern spray • WaterMark AS/NZS 3662 WMKT 21147 • 3 Star 9L/min as per WELS licence number 0046 	
	TW 039QU C	Chrome	695.00	764.50		

- Cosmic ABS 256mm rainmaker shower rose
- 800mm x 25mm rail with adjustable brackets
- Swan neck swivelling shower arm
- Brass friction slide cradle
- Diverter switchcock valve
- Licenced dual check/non-return valve
- 57mm solid brass round flat flange
- 1500mm PVC hose



Model	Code	Finish	Without GST	With GST	Features
-------	------	--------	-------------	----------	----------



STREAMJET™					
	TOP INLET				<ul style="list-style-type: none"> • ABS 100mm single function shower • Concentric full pattern spray • Rub-clean spray diffuser • WaterMark AS 3662 WMKT 21147 • Available in 3 Star 9L/min as per WELS licence number 0046
	TW 025CJ BN	Brushed Nickel	885.00	973.50	
	TW 025CJ C	Chrome	665.00	731.50	
	TW 025CJ MB	Matte Black	825.00	907.50	
	BOTTOM INLET				
	TW 035CJ BN	Brushed Nickel	930.00	1023.00	
TW 035CJ C	Chrome	710.00	781.00		
TW 035CJ MB	Matte Black	870.00	957.00		

STREAMJET™ TURBO PULSATOR					
	TOP INLET				<ul style="list-style-type: none"> • ABS 100mm multi-function shower • Soft, pulsating and bubble spray functions • Rub-clean spray diffuser • WaterMark AS 3662 WMKT 21147 • Available in 3 Star 9L/min as per WELS licence number 0046
	TW 025CT C	Chrome	695.00	764.50	
	BOTTOM INLET				
	TW 035CT C	Chrome	740.00	814.00	

STREAMJET™ XL					
	TOP INLET				<ul style="list-style-type: none"> • ABS 130mm single function shower • Concentric full pattern spray • Rub-clean spray diffuser • WaterMark AS 3662 WMKT 21147 • Available in 3 Star 9L/min as per WELS licence number 0046
	TW 025CX BN	Brushed Nickel*	920.00	1012.00	
	TW 025CX C	Chrome	690.00	759.00	
	TW 025CX MB	Matte Black*	860.00	946.00	
	BOTTOM INLET				
	TW 035CX BN	Brushed Nickel*	965.00	1061.50	
TW 035CX C	Chrome	735.00	808.50		
TW 035CX MB	Matte Black*	905.00	995.50		

STREAMJET™ XL TURBO PULSATOR					
	TOP INLET				<ul style="list-style-type: none"> • ABS 130mm multi-function shower • Soft, pulsating and bubble spray functions • Rub-clean spray diffuser • WaterMark AS 3662 WMKT 21147 • Available in 3 Star 9L/min as per WELS licence number 0046
	TW 025CS C	Chrome	720.00	792.00	
	BOTTOM INLET				
	TW 035CS C	Chrome	765.00	841.50	

PRINCESS					
	TOP INLET				<ul style="list-style-type: none"> • ABS 83mm arched single function shower • Full pattern spray • Rub-clean spray diffuser • WaterMark AS 3662 WMKT 21147 • Available in 3 Star 9L/min as per WELS licence number 0046
	TW 025CP C	Chrome	650.00	715.00	
	BOTTOM INLET				
	TW 035CP C	Chrome	695.00	764.50	

BREEZE					
	TOP INLET				<ul style="list-style-type: none"> • ABS 104mm arched multi-function shower • Soft, pulsating and bubble spray functions • Rub-clean spray diffuser • Available in 3 Star 9L/min as per WELS licence number 0046
	TW 025CZ C	Chrome	667.00	733.70	
	BOTTOM INLET				
	TW 035CZ C	Chrome	712.00	783.20	

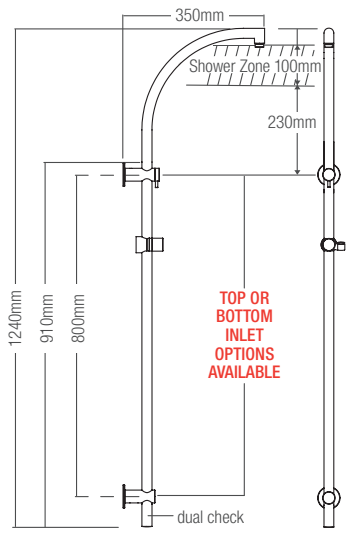

Model shown: TW 025CJ C



COMBINATION SHOWERS TWIN WATERS™

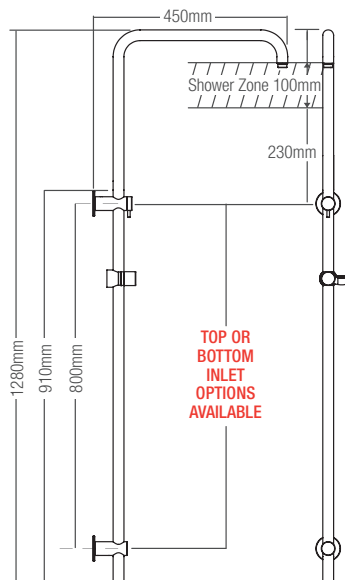

TWIN WATERS™ - COSMIC CRANE ARM



- Cosmic ABS 256mm rainmaker shower rose
- 800mm x 25mm rail with adjustable brackets
- Crane neck swivelling shower arm
- Brass friction slide cradle
- Diverter switchcock valve
- Licenced dual check/non-return valve
- 57mm solid brass round flat flange
- 1500mm PVC hose







Model	Code	Finish	Without GST	With GST	Features
-------	------	--------	-------------	----------	----------



STREAMJET™					
	TOP INLET				<ul style="list-style-type: none"> • ABS 100mm single function shower • Concentric full pattern spray • Rub-clean spray diffuser • WaterMark AS 3662 WMKT 21147 • Available in 3 Star 9L/min as per WELS licence number 0046 
	TW 029CJ BN	Brushed Nickel	885.00	973.50	
	TW 029CJ C	Chrome	665.00	731.50	
	TW 029CJ MB	Matte Black	825.00	907.50	
	BOTTOM INLET				
	TW 039CJ BN	Brushed Nickel	930.00	1023.00	
	TW 039CJ C	Chrome	710.00	781.00	
	TW 039CJ MB	Matte Black	870.00	957.00	

STREAMJET™ TURBO PULSATOR					
	TOP INLET				<ul style="list-style-type: none"> • ABS 100mm multi-function shower • Soft, pulsating and bubble spray functions • Rub-clean spray diffuser • WaterMark AS 3662 WMKT 21147 • Available in 3 Star 9L/min as per WELS licence number 0046 
	TW 029CT C	Chrome	695.00	764.50	
	BOTTOM INLET				
	TW 039CT C	Chrome	740.00	814.00	

STREAMJET™ XL					
	TOP INLET				<ul style="list-style-type: none"> • ABS 130mm single function shower • Concentric full pattern spray • Rub-clean spray diffuser • WaterMark AS 3662 WMKT 21147 • Available in 3 Star 9L/min as per WELS licence number 0046 
	TW 029CX BN	Brushed Nickel*	920.00	1012.00	
	TW 029CX C	Chrome	690.00	759.00	
	TW 029CX MB	Matte Black*	860.00	946.00	
	BOTTOM INLET				
	TW 039CX BN	Brushed Nickel*	965.00	1061.50	
	TW 039CX C	Chrome	735.00	808.50	
	TW 039CX MB	Matte Black*	905.00	995.50	

STREAMJET™ XL TURBO PULSATOR					
	TOP INLET				<ul style="list-style-type: none"> • ABS 130mm multi-function shower • Soft, pulsating and bubble spray functions • Rub-clean spray diffuser • WaterMark AS 3662 WMKT 21147 • Available in 3 Star 9L/min as per WELS licence number 0046 
	TW 029CS C	Chrome	720.00	792.00	
	BOTTOM INLET				
	TW 039CS C	Chrome	765.00	841.50	

PRINCESS					
	TOP INLET				<ul style="list-style-type: none"> • ABS 83mm arched single function shower • Full pattern spray • Rub-clean spray diffuser • WaterMark AS 3662 WMKT 21147 • Available in 3 Star 9L/min as per WELS licence number 0046 
	TW 029CP C	Chrome	650.00	715.00	
	BOTTOM INLET				
	TW 039CP C	Chrome	695.00	764.50	

BREEZE					
	TOP INLET				<ul style="list-style-type: none"> • ABS 104mm arched multi-function shower • Soft, pulsating and bubble spray functions • Rub-clean spray diffuser • Available in 3 Star 9L/min as per WELS licence number 0046 
	TW 029CZ C	Chrome	667.00	733.70	
	BOTTOM INLET				
	TW 039CZ C	Chrome	712.00	783.20	



Model shown: TW 029CT C

SPARE PARTS ELBOWS AND BRACKETS





Con-Serv wall elbow and brackets include non-return valves as per WaterMark Licence 02696. This removes the possibility of a handheld shower being the source of backflow contamination to the water supply should it be immersed in the bath or other vessel.



	Code	Finish	Without GST	With GST	Features
ANTI-LIGATURE WALL OUTLET ELBOW WITH DUAL CHECK VALVE					
	EB 044 C	Chrome	55.00	60.50	<ul style="list-style-type: none"> • 50mm anti-ligature wall outlet elbow • Force release mechanism releases hose from wall outlet elbow when 10kg of weight is applied. • Brass construction • ½" BSP female inlet with ½" BSP male threaded outlet • Licenced dual check/non-return as per WaterMark AS/NZS 2845.1 WMKA 02696 (dual check valve only)
WALL OUTLET ELBOW WITH DUAL CHECK VALVE					
	EB 045 C	Chrome	50.00	55.00	<ul style="list-style-type: none"> • 50mm wall outlet elbow • Brass construction • ½" BSP female inlet with ½" BSP male threaded outlet • Licenced dual check/non-return as per WaterMark AS/NZS 2845.1 WMKA 02696 (dual check valve only)
WALL OUTLET ELBOW WITH DUAL CHECK VALVE					
	EB 046 AWC	Antimicrobial White/Chrome	66.00	72.60	<ul style="list-style-type: none"> • 55mm wall outlet elbow • Brass 57mm wall flange • Flow Interchange® spigot • ½" BSP female inlet with ½" BSP male threaded outlet • Licenced dual check/non-return as per WaterMark AS/NZS 2845.1 WMKA 02696 (dual check valve only)
	EB 046 BN	Brushed Nickel	72.00	79.20	
	EB 046 C	Chrome	55.00	60.50	
	EB 046 MB	Matte Black	72.00	79.20	
WALL OUTLET ELBOW BRACKET WITH DUAL CHECK VALVE					
	EB 073 AWC	Antimicrobial White/Chrome	110.00	121.00	<ul style="list-style-type: none"> • 85mm right-angled wall outlet handset bracket • Brass 57mm wall flange • Flow Interchange® spigot • ½" BSP female inlet with ½" BSP male threaded outlet • Licenced dual check/non-return as per WaterMark AS/NZS 2845.1 WMKA 02696 (dual check valve only)
	EB 073 BN	Brushed Nickel	130.00	143.00	
	EB 073 C	Chrome	100.00	110.00	
	EB 073 MB	Matte Black	130.00	143.00	
WALL MOUNT HANDSET BRACKET					
	EB 074 C	Chrome	90.00	99.00	<ul style="list-style-type: none"> • 85mm right-angled wall mount handset bracket • Dual screw wall mount • Brass construction • Brass 57mm wall flange
	EB 074 MB	Matte Black	120.00	132.00	
SQUARE-EDGE WALL OUTLET ELBOW WITH DUAL CHECK VALVE					
	EB 075 C	Chrome	70.00	77.00	<ul style="list-style-type: none"> • 55mm Square-edge wall outlet elbow • Brass construction • Brass 57mm wall flange • Flow Interchange® spigot • Licenced dual check/non-return as per WaterMark AS/NZS 2845.1 WMKA 02696 (dual check valve only)
ON/OFF BUTTON CONTROL VALVE					
	DV 044 C	Chrome	24.00	26.40	<ul style="list-style-type: none"> • On/off shower valve • Brass construction • Not to be used as a line end stop control
WALL MOUNT ABS HANDSET BRACKET					
	EB 085 C	Chrome	20.00	22.00	<ul style="list-style-type: none"> • 70mm ABS wall mount handset bracket • Fixed position, not adjustable • Dual screw fixing • Stainless steel fixings supplied









SPARE PARTS RAILS AND FLANGES

The Friction Slide Handset Support Cradle on these rails is designed for persons with weakened wrist, arthritic or grip problems. When installed in a moist environment (such as a bathroom) the slider will adjust easily. It may grip to the rail in a dry environment (such as a display room).

	Code	Finish	Without GST	With GST	Features
SLIDE RAILS					
	CRYSTAL SLIDE RAIL (A)				
	SR 010 AWC	Antimicrobial White/Chrome	130.00	143.00	<ul style="list-style-type: none"> Brass 700mm low profile track Brass friction slide cradle, track supports and end caps
	SR 010 C	Chrome	130.00	143.00	
	POLAR SLIDE RAIL (B)				
	SR 020 AWC	Antimicrobial White/Chrome	205.00	225.50	<ul style="list-style-type: none"> Brass 700mm, centre to centre rail Brass friction slide cradle for handset support and height adjustment Brass wall brackets and 57mm wall flanges
	SR 020 BN	Brushed Nickel	240.00	264.00	
	SR 020 C	Chrome	195.00	214.50	
	SR 020 MB	Matte Black	240.00	264.00	
	QUEWB SLIDE RAIL (C)				
	SR 028 C	Chrome	90.00	99.00	<ul style="list-style-type: none"> Brass 700mm low profile track Square edge design Brass friction slide cradle for handset adjustment
	RIVIERA SLIDE RAIL (D)				
	SR 026 BN	Brushed Nickel	420.00	462.00	<ul style="list-style-type: none"> Brass 800mm rail with adjustable lower bracket Concealed top inlet; Flow Interchange® spigot Brass friction slide cradle and 57mm wall flanges PVC 1500mm hose with ½" BSP swivel conical end nut
	SR 026 C	Chrome	350.00	385.00	
	SR 026 MB	Matte Black	420.00	462.00	
TWIN WATERS™ SLIDE RAILS AND EXTENSIONS					
	CRANE NECK TWIN WATERS™ SLIDE RAIL (A)				
	SR 029 BN	Brushed Nickel	620.00	682.00	<ul style="list-style-type: none"> Brass 800mm rail with 380mm swivel arm Brass friction slide cradle and 19mm female inlet diverter switchcock valve with flow Interchange® spigot PVC 1500mm Silverflex™ hose
	SR 029 C	Chrome	510.00	561.00	
	SR 029 MB	Matte Black	620.00	682.00	
	SWAN NECK TWIN WATERS™ SLIDE RAIL (B)				
	SR 025 BN	Brushed Nickel	620.00	682.00	<ul style="list-style-type: none"> Brass 800mm rail with 345mm swivel arm Brass friction slide cradle and 19mm female inlet diverter switchcock valve with flow Interchange® spigot PVC 1500mm Silverflex™ hose
	SR 025 C	Chrome	510.00	561.00	
	SR 025 MB	Matte Black	620.00	682.00	
	TWIN WATERS™ RAIL TUBE (NOT PICTURED)				
	SR 400 C RA	Chrome	50.00	55.00	<ul style="list-style-type: none"> Brass 400mm reduced length 25mm rail tube for Twin Waters™ showers
	TWIN WATERS™ 140MM CRANE ARM TUBE ONLY (C)				
	SP 140 C TO	Chrome	70.00	77.00	<ul style="list-style-type: none"> Low rise option for Twin Waters™ overhead arm Brass construction
	SP 140 MB TO	Matte Black	100.00	110.00	
	TWIN WATERS™ OVERHEAD EXTENSIONS (NOT PICTURED)				
SR 025 C OS	Chrome 100mm	80.00	88.00	<ul style="list-style-type: none"> Brass 25mm extended overhead connector for Twin Waters™ Available in 100mm, 200mm and 300mm extensions 	
SR 025 C OM	Chrome 200mm	110.00	121.00		
SR 025 C OL	Chrome 300mm	140.00	154.00		
DOMED WALL FLANGE - ROUND					
	WF 057 AW DO	Antimicrobial White	6.00	6.60	<ul style="list-style-type: none"> Brass 57mm domed wall flange 8mm dome height (total)
	WF 057 C DO	Chrome	2.00	2.20	
FLAT WALL FLANGE - ROUND					
	WF 057 AW FL	Antimicrobial White	14.00	15.00	<ul style="list-style-type: none"> Brass 57mm wall flange
	WF 057 BN FL	Brushed Nickel	15.00	16.50	
	WF 057 C FL	Chrome	9.00	9.90	
	WF 057 MB FL	Matte Black	15.00	16.50	
FLAT WALL FLANGE - SQUARE					
	WF 057 C QU	Chrome	15.00	16.50	<ul style="list-style-type: none"> Brass 57mm wall flange

SPARE PARTS SHOWER ARMS

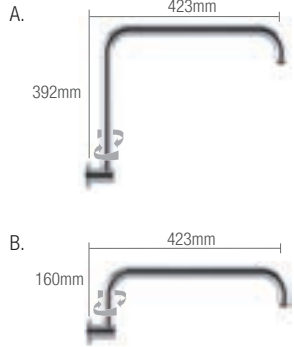





All Con-Serv shower arm attachments are sold NON Water Saving (NWS).
Con-Serv's Water Efficiency Licence number 0046 only covers testing on shower arm and shower rose combinations.

	Code	Finish	Without GST	With GST	Features
CLICKLOCK™ ORBITAL/ADJUSTABLE ARM					
 <p>360° Accepts 130mm maximum ABS rose size only</p>	SA 060 AWC	Antimicrobial White/Chrome	110.00	121.00	<ul style="list-style-type: none"> Clicklock™ 300mm adjustable height shower arm Orbital swivelling end Brass construction Brass 57mm wall flange Full flow Interchange® spigot ½" BSP female inlet with ½" BSP male threaded outlet
	SA 060 BN	Brushed Nickel	130.00	143.00	
	SA 060 C	Chrome	100.00	110.00	
	SA 060 MB	Matte Black	130.00	143.00	
GRAND ARM					
	SA 165 AW	Antimicrobial White	76.00	83.60	<ul style="list-style-type: none"> 165mm upswept fixed shower arm Brass construction ½" BSP female inlet with ½" BSP male threaded outlet
	SA 165 C	Chrome	71.00	78.10	
HORIZONTAL ARM 310MM					
	SA 310 C	Chrome	76.00	83.60	<ul style="list-style-type: none"> 310mm horizontal shower arm Brass construction Brass 57mm wall flange Full flow Interchange® spigot ½" BSP female inlet with ½" BSP male threaded outlet
	SA 310 MB	Matte Black	99.00	108.90	
HORIZONTAL ARM 450MM					
	SA 450 BN HZ	Brushed Nickel	95.00	104.50	<ul style="list-style-type: none"> 450mm extended projection horizontal arm 316 stainless steel construction for added strength 316 stainless steel 62mm wall flange Full flow Interchange® spigot ½" BSP female inlet with ½" BSP male threaded outlet
	SA 450 C HZ	Chrome	80.00	88.00	
	SA 450 MB HZ	Matte Black	95.00	104.50	
LIMITED PROJECTION ARM					
	SA 005 C	Chrome	30.00	33.00	<ul style="list-style-type: none"> 55mm x 20° fixed shower arm Brass construction Brass 57mm wall flange Full flow Interchange® spigot ½" BSP female inlet with ½" BSP male threaded outlets
SWAN NECK RISING ARM					
	SA 090 AWC	Antimicrobial White/Chrome	75.00	82.50	<ul style="list-style-type: none"> 290mm swan neck shower arm Most suitable for gravity fed shower applications Brass construction Brass 57mm wall flange Full flow Interchange® spigot ½" BSP female inlet with ½" BSP male threaded outlet
	SA 090 BN	Brushed Nickel	95.00	104.50	
	SA 090 C	Chrome	60.00	66.00	
	SA 090 MB	Matte Black	95.00	104.50	
SWIVEL CRANE NECK ARM					
 <p>A. 423mm, 392mm B. 423mm, 160mm</p>	380MM ARM (A)				<ul style="list-style-type: none"> Swivel crane neck shower arm Brass construction Brass 57mm wall flange Full flow Interchange® spigot ½" BSP female inlet with ½" BSP male threaded outlet
	SA 380 BN	Brushed Nickel	190.00	209.00	
	SA 380 C	Chrome	145.00	159.50	
	SA 380 MB	Matte Black	190.00	209.00	
	140MM ARM (B)				
	SA 140 C	Chrome	75.00	82.50	
	SA 140 MB	Matte Black	110.00	121.00	
	140MM CRANE ARM TUBE ONLY (NOT PICTURED)				
	SP 140 C TO	Chrome	70.00	77.00	
	SP 140 MB TO	Matte Black	100.00	110.00	
SWIVEL SWAN NECK ARM					
	SA 345 C	Chrome	125.00	137.50	<ul style="list-style-type: none"> 345mm swan neck swivelling shower arm Brass construction Brass 57mm wall flange Full flow Interchange® spigot ½" BSP female inlet with ½" BSP male threaded outlet
	SA 345 MB	Matte Black	165.00	181.50	

SPARE PARTS

SHOWER ARMS, SLIDERS AND ACCESSORIES

All Con-Serv shower arm attachments are sold NON Water Saving (NWS).
Con-Serv's Water Efficiency Licence number 0046 only covers testing on shower arm and shower rose combinations.

	Code	Finish	Without GST	With GST	Features
UPSWEPT FIXED ARM					
	SA 030 AW	Antimicrobial White	60.00	66.00	<ul style="list-style-type: none"> • 150mm upswept fixed shower arm • Brass construction • Brass 57mm wall flange • Full flow Interchange® spigot • ½" BSP female inlet with ½" BSP male threaded outlet
	SA 030 BN	Brushed Nickel	65.00	71.50	
	SA 030 C	Chrome	50.00	55.00	
	SA 030 MB	Matte Black	65.00	71.50	
UPSWEPT ADJUSTABLE ARM					
	SA 070 AWC	Antimicrobial White/Chrome	21.00	23.10	<ul style="list-style-type: none"> • 260mm upswept adjustable height shower arm • Brass construction • 57mm domed wall flange • ½" BSP female inlet with ½" BSP male threaded outlet
	SA 070 C	Chrome	18.00	19.80	
	REPLACEMENT ADJUSTABLE ARM OLIVE				
	SP 063	2 pack	4.00	4.40	
VERTICAL ARM					
 <div style="position: absolute; top: 355px; left: 180px;">62mm</div> <div style="position: absolute; top: 365px; left: 245px; border: 1px solid red; border-radius: 50%; padding: 2px; color: white; font-weight: bold;">NEW SIZES</div> <div style="position: absolute; top: 435px; left: 130px; transform: rotate(-90deg);">150mm/300mm/450mm/600mm</div>	150MM VERTICAL ARM				<ul style="list-style-type: none"> • Vertical shower arm for ceiling installations • Available in lengths of 150mm, 300mm, 450mm and 600mm • Brass construction • Brass 62mm wall flange • Full flow Interchange® spigot • ½" BSP female inlet with ½" BSP male threaded outlet
	SA 150 BN	Brushed Nickel	45.00	49.50	
	SA 150 C	Chrome	35.00	38.50	
	SA 150 MB	Matte Black	45.00	49.50	
	300MM VERTICAL ARM				
	SA 300 BN	Brushed Nickel	59.00	64.90	
	SA 300 C	Chrome	45.00	49.50	
	SA 300 MB	Matte Black	59.00	64.90	
	450MM VERTICAL ARM				
	SA 450 BN	Brushed Nickel	72.00	79.20	
	SA 450 C	Chrome	55.00	60.50	
	SA 450 MB	Matte Black	72.00	79.20	
	600MM VERTICAL ARM				
	SA 600 BN	Brushed Nickel	95.00	104.50	
	SA 600 C	Chrome	70.00	77.00	
SA 600 MB	Matte Black	95.00	104.50		
ABS SLIDE RAIL HANDPIECE GLIDE SLIDE CRADLE					
	HC 025 C	Chrome	25.00	27.50	<ul style="list-style-type: none"> • Fastens to 25mm slide rail • ABS construction • Push-button lock mechanism
	HC 025 WT	White	20.00	22.00	
BRASS FRICTION SLIDE HANDPIECE CRADLE					
	HC 020 AWC	Antimicrobial White/Chrome	105.00	115.00	<ul style="list-style-type: none"> • Suitable for Con-Serv 25mm Polar slide rail • Brass construction
	HC 020 BN	Brushed Nickel	130.00	143.00	
	HC 020 C	Chrome	100.00	110.00	
	HC 020 MB	Matte Black	130.00	143.00	
CRYSTAL FRICTION SLIDE HANDPIECE CRADLE					
	HC 010 AWC	Antimicrobial White/Chrome	70.00	77.00	<ul style="list-style-type: none"> • Suitable for Con-Serv 25mm Crystal slide track only • Brass construction
	HC 010 C	Chrome	66.00	72.60	
RAIL SOAP DISH					
	SD 025 CL	Clear	20.00	22.00	<ul style="list-style-type: none"> • Fastens to 25mm tubular rails • ABS construction • 115mm x 175mm • Self-draining













SPARE PARTS SHOWER HANDPIECES

Handpieces must be installed with a Con-Serv water outlet component to achieve the licenced WELS rating. Handpieces that provide restriction at the showerhead, subject the hose to back pressure which shortens the life of the hose and could dislodge the handpieces.

	Code	Finish	Without GST	With GST	Features	
STREAMJET™						
	HP 038 BN	Brushed Nickel	125.00	137.50	<ul style="list-style-type: none"> • ABS 100mm single function shower • Concentric full pattern spray • Rub-clean spray diffuser • WaterMark AS 3662 WMKT 21147 • Available in 3 Star 9L/min and 4 Star 6.5L/min as per WELS licence number 0046 • To achieve the WELS 3 Star or 4 Star rating, this product must be installed with a Con-Serv wall outlet component 	
	HP 038 C	Chrome	65.00	71.50		
	HP 038 MB	Matte Black	85.00	93.50		
	HP 038 WT	White	50.00	55.00		
STREAMJET™ TURBO PULSATOR						
	HP 042 C	Chrome	95.00	104.50	<ul style="list-style-type: none"> • ABS 100mm multi-function shower • Soft, pulsating and bubble spray functions • Rub-clean spray diffuser • WaterMark AS 3662 WMKT 21147 • 3 Star 9L/min as per WELS licence number 0046 • To achieve the WELS 3 Star rating, this product must be installed with a Con-Serv wall outlet component 	
STREAMJET™ XL						
	HP 130 BN	Brushed Nickel*	160.00	176.00	<ul style="list-style-type: none"> • ABS 130mm extra-large single function shower • Concentric full pattern spray • Rub-clean spray diffuser • WaterMark AS 3662 WMKT 21147 • 3 Star 9L/min as per WELS licence number 0046 • To achieve the WELS 3 Star rating, this product must be installed with a Con-Serv wall outlet component 	
	HP 130 C	Chrome	90.00	99.00		
	HP 130 MB	Matte Black*	120.00	132.00		
		*AVAILABLE JULY 2022				
STREAMJET™ XL TURBO						
	HP 142 C	Chrome	120.00	132.00	<ul style="list-style-type: none"> • ABS 130mm multi-function shower • Soft, pulsating, and bubble spray functions • Rub-clean spray diffuser • WaterMark AS 3662 WMKT 21147 • 3 Star 9L/min as per WELS licence number 0046 • To achieve the WELS 3 Star rating, this product must be installed with a Con-Serv wall outlet component 	
QUEWB						
	HP 041 C	Chrome	50.00	55.00	<ul style="list-style-type: none"> • ABS 81mm square shaped shower • Low impact spray • Rub-clean spray diffuser • WaterMark AS/NZS 3662 WMKT 21147 • 3 Star 9L/min as per WELS licence number 0046 • To achieve the WELS 3 Star rating, this product must be installed with a Con-Serv wall outlet component 	

SPARE PARTS SHOWER HANDPIECES

Handpieces must be installed with a Con-Serv water outlet component to achieve a 3 Star - 9L/min WELS rating. Handpieces that provide restriction at the showerhead, subject the hose to back pressure which shortens the life of the hose and could dislodge the handpieces.









	Code	Finish	Without GST	With GST	Features	
BREEZE						
	HP 037 C	Chrome	66.00	72.60	<ul style="list-style-type: none"> • ABS 104mm arched multi-function shower • Soft, pulsating, and bubble spray functions • Rub-clean spray diffuser • WaterMark AS 3662 WMKT 21147 • 3 Star 9L/min as per WELS licence number 0046 • To achieve the WELS 3 Star rating, this product must be installed with a Con-Serv wall outlet component 	
HOSCARE®						
  	HP 030 AC	Antimicrobial Chrome	45.00	49.50	<ul style="list-style-type: none"> • ABS 100mm single function shower with Biomaster antimicrobial additive • Concentric full pattern spray • Rub-clean spray diffuser • WaterMark AS 3662 WMKT 21147 • Available in 3 Star 9L/min and 4 Star 6.5L/min as per WELS licence number 0046 • To achieve the WELS 3 Star or 4 Star rating, this product must be installed with a Con-Serv wall outlet component 	
	HP 030 AW	Antimicrobial White	35.00	38.50		
PRINCESS						
	HP 034 C	Chrome	50.00	55.00	<ul style="list-style-type: none"> • ABS 83mm arched multi-function shower • Full pattern spray • Rub-clean spray diffuser • WaterMark AS 3662 WMKT 21147 • 3 Star - 9 L/min as per WELS licence number 0046 • To achieve the WELS 3 Star rating, this product must be installed with a Con-Serv wall outlet component 	
HOSFAB®						
	HP 035 AW	Antimicrobial White	35.00	38.50	<ul style="list-style-type: none"> • ABS 69mm lightweight single function shower • Full pattern spray • Rub-clean spray diffuser • WaterMark AS 3662 WMKT 21147 • 3 Star 9L/min as per WELS licence number 0046 • To achieve the WELS 3 Star rating, this product must be installed with a Con-Serv wall outlet component 	
	HP 035 C	Chrome	45.00	49.50		
	HP 035 SW	Seasonal Inserts	35.00	38.50		
KLIPPER						
	HP 025 C	Chrome	40.00	44.00	<ul style="list-style-type: none"> • ABS 58mm side lever shower • On/off lock function • Firm pattern spray • WaterMark AS/NZS 3662 WMKT 21147 • 3 Star 9L/min as per WELS licence number 0046  <p>NOT TO BE USED AS LINE END STOP CONTROL. COULD CAUSE THERMAL SHOCK.</p>	
	HP 025 WT	White	30.00	33.00		

SPARE PARTS SHOWER HOSES

Con-Serv offer an extensive range of shower hoses in various finishes and standard lengths. PVC hoses can be made to any custom length P.O.A.



WaterMark
AS 3962
WMKT 21147

	Code	Length	Finish	Without GST	With GST	Features
SILVERFLEX® SMOOTH SURFACE HOSE - PVC						
	SH 0900 CS	900mm	Chrome Silverflex®	44.00	48.40	<ul style="list-style-type: none"> For use with handheld showers Smooth PVC hose with elastic inner supported by polyester cords 1 x ½" BSP swivel and 1 x ½" BSP fixed conical end nuts Chrome finish
	SH 1200 CS	1200mm	Chrome Silverflex®	47.00	51.70	
	SH 1500 CS	1500mm	Chrome Silverflex®	50.00	55.00	
	SH 2000 CS	2000mm	Chrome Silverflex®	55.00	60.50	
MATTE BLACK SMOOTH SURFACE HOSE - PVC						
	SH 0900 MB	900mm	Matte Black	59.00	64.90	<ul style="list-style-type: none"> For use with handheld showers Smooth PVC hose with elastic inner supported by polyester cords 1 x ½" BSP swivel and 1 x ½" BSP fixed conical end nuts Matte black hose with matching components
	SH 1200 MB	1200mm	Matte Black	62.00	68.20	
	SH 1500 MB	1500mm	Matte Black	65.00	71.50	
	SH 2000 MB	2000mm	Matte Black	70.00	77.00	
BRUSHED NICKEL SMOOTH SURFACE HOSE - PVC						
	SH 0900 BN	900mm	Brushed Nickel	59.00	64.90	<ul style="list-style-type: none"> For use with handheld showers Smooth PVC hose with elastic inner supported by polyester cords 1 x ½" BSP swivel and 1 x ½" BSP fixed conical end nuts Brushed Nickel finish
	SH 1200 BN	1200mm	Brushed Nickel	62.00	68.20	
	SH 1500 BN	1500mm	Brushed Nickel	65.00	71.50	
	SH 2000 BN	2000mm	Brushed Nickel	70.00	77.00	
ANTIMICROBIAL SMOOTH SURFACE HOSE - PVC						
	SH 0900 AW	900mm	Antimicrobial White	39.00	42.90	<ul style="list-style-type: none"> For use with handheld showers Smooth PVC hose with antimicrobial inner Non-phthalate flexible PVC outer with antimicrobial additive 1 x ½" BSP swivel and 1 x ½" BSP fixed conical end nuts
	SH 1200 AW	1200mm	Antimicrobial White	42.00	46.20	
	SH 1500 AW	1500mm	Antimicrobial White	45.00	49.50	
	SH 2000 AW	2000mm	Antimicrobial White	50.00	55.00	
REINFORCED SOFTFLEX® SMOOTH SURFACE HOSE - PVC						
	SH 0900 WR	900mm	Reinforced White	26.00	28.60	<ul style="list-style-type: none"> For use with handheld showers Smooth PVC hose with elastic inner strengthened by woven polyester cords 1 x ½" BSP swivel and 1 x ½" BSP fixed conical end nuts White reinforced hose with chrome plated brass components
	SH 1200 WR	1200mm	Reinforced White	29.00	31.90	
	SH 1500 WR	1500mm	Reinforced White	32.00	35.20	
	SH 2000 WR	2000mm	Reinforced White	37.00	40.70	
METAL HOSE DOUBLE HOOK & LOOP - AGRAFF						
	SH 1500 C ME	1500mm	Chrome	45.00	49.50	<ul style="list-style-type: none"> For use with handheld showers Spiral metal hose with elastic inner Double hook and loop (Agraff) outer casing ½" BSP fixed conical end nuts Chrome plated finish
	SH 2000 C ME	2000mm	Chrome	58.00	63.80	
HOSE FOR TWIN WATERS™ SHOWERS - PVC						
	SH 1500 BN TW	1500mm	Brushed Nickel	80.00	88.00	<ul style="list-style-type: none"> For use with Riviera and Twin Waters™ rails Elastic inner with polyester cords and nylon smooth hose and clear PVC outer sheath 1 x ½" BSP swivel conical end nut and 1 x ½" BSP Twin Waters™ hose nut
	SH 1500 CS TW	1500mm	Chrome Silverflex®	65.00	71.50	
	SH 1500 MB TW	1500mm	Matte Black	80.00	88.00	
PVC SMOOTH SHOWER HOSE - BULK						
	SH 0025 AW	25m	Antimicrobial White	400.00	440.00	<ul style="list-style-type: none"> 25m For use with handheld showers Smooth PVC hose with elastic inner supported by polyester cords
	SH 0025 CS	25m	Chrome Silverflex®	490.00	539.00	
	SH 0025 MB	25m	Matte Black	350.00	385.00	
	SH 0025 WR	25m	Reinforced White	350.00	385.00	
PVC SPIRAL SHOWER HOSE - BULK						
	SH 0025 WT	25m	Softflex® White	350.00	385.00	<ul style="list-style-type: none"> 25m For use with handheld showers Spiral PVC hose with elastic inner supported by polyester cords

SPARE PARTS SHOWER HOSE PARTS

Con-Serv stock a range of hose spare parts and accessories. Items can be purchased individually, or as part of our Tradesman Hose Repair Kits which can be topped up as required.

	Code	Finish	Without GST	With GST	Features	
EEL GRIP SEALS (20 PACK)						
	SH 027 GR EG	Green	18.00	19.80	<ul style="list-style-type: none"> Eel Grip Seal - Delrin 20 pack For use with shower hoses 	
WASHERS - NITRIL N70 (20 PACK)						
	SH 027 BL HW	Black	21.00	23.10	<ul style="list-style-type: none"> Washers - EPDM 20 Pack For use with handheld showers 	
HOSE SLEEVES - 14mm/15mm (20 PACK)						
	SH 027 C SV	Grey 14mm	20.00	22.00	<ul style="list-style-type: none"> Available in 14mm ID (20 pack) or 15mm ID (20 pack) 	
	SH 027 C LV	Grey 15mm	20.00	22.00		
CONICAL END NUTS (10 PACK)						
	SH 027 C CN	Chrome	40.00	44.00	<ul style="list-style-type: none"> ½" BSP female 10 pack Chrome plated finish 	
TRADESMAN HOSE REPAIR KIT						
	SH 027 TR	Tool Kit	95.00	104.50	<p>CONTENTS:</p> <ul style="list-style-type: none"> 1 x Hose repair hand vice tool 1 x Trimming Knife 20 x 14mm Hose sleeves 40 x Hose gaskets 20 x 15mm Hose sleeves 1 x 3.5m Tape measure 20 x Hose seal plugs 10 x Conical end nuts Instructions included 	
SWITCHCOCK VALVE						
	DV 021 C	Chrome	60.00	66.00	<ul style="list-style-type: none"> Two-way switchcock diverter valve Brass construction ½" BSP female threaded inlet with front and bottom ½" BSP male threaded outlets Suitable for installation where a fixed overhead shower and handheld shower are required Not to be used as a line end stop control 	
HOSE RESTRICTOR BRACKET						
	HR 015 BN	Brushed Nickel	65.00	71.50	<ul style="list-style-type: none"> Wall mounted hose retainer Suited to accessible showers with 1500mm hose in close proximity to WC Dual screw wall mount plate Stainless steel fixings supplied 	
	HR 015 C	Chrome	50.00	55.00		
	HR 015 MB	Matte Black	65.00	71.50		
HOB MOUNT SET						
	HM 019 C	Chrome	76.00	83.60	<ul style="list-style-type: none"> ABS 50mm bench mount collar with 26mm continuous thread and lock nut PVC 1500mm reinforced hose with ½" BSP swivel conical end nut Shower sold separately This product may need future service. Ensure an access panel is installed when fitting to spa baths and tubs. <p>Con-Serv recommends a DC 043 (page 48) dual check prevention valve is installed with this product.</p>	
	HM 019 WTC	White/Chrome	70.00	77.00		



Flow Control Valves

In plumbing, a flow control valve regulates the flow of water from an open outlet like a kitchen or bathroom tap. Flow control valves are generally small in size and vary in function and shape, so it is important to understand what and where you are installing to ensure you get the correct device. All Con-Serv flow control valves feature a constant flow regulator which ensures a guaranteed nominal flow rate e.g. 9L/min irrespective of the pressure (the force) behind the water. In Australia, the average working pressure range in most households is generally 350kPa (kilopascals), however Con-Serv valves will function at a low 150kPa through to a high of 500kPa. Con-Serv stock a range of flow control devices including Aerators, Inline Flow Control Valves and Dual Check/Non-Return Valves.

WELS

About the Water Efficiency Labelling and Standards scheme

The Water Efficiency Labelling and Standards (WELS) scheme is Australia's urban water saving scheme. The WELS scheme uses a rating system to help consumers make informed choices about the water efficiency of products they purchase.

WELS estimates show that using water efficient products could save Australians more than \$2 billion by 2030, with an average saving of \$175 per household each year.

- 65% of these savings are from reduced electricity and gas costs from avoided water heating
- 35% of these savings are from reduced water bills

Management of the scheme is the responsibility of the Department of Agriculture and Water Resources, working in partnership with industry and state and territory governments.

The purpose of the WELS scheme is to:

- Conserve water supplies by reducing water consumption;
- Promote the adoption of efficient and effective water-using and water saving technologies; and
- Provide information for purchasers of water-using and water saving products.

WELS achieve these objectives by specifying and enforcing standards for water efficiency and labelling for a range of regulated water-using appliances, fixtures and fittings.

To learn more about WELS visit www.waterrating.gov.au

WaterMark

What is the WaterMark Certification Scheme

The WaterMark Certification Scheme is a mandatory certification scheme for plumbing and drainage products. Certification ensures products are fit for purpose and appropriately authorised for use in plumbing and drainage installations. The Australian Building Codes Board administers and manages the Scheme.

To install plumbing and drainage products in Australia, including those purchased via online stores like eBay and Amazon, the product must be:

- WaterMark certified;
- Marked with the WaterMark trade mark, WaterMark licence number and the applicable product specification;
- Listed on the WaterMark product database and provided with a Scope of Use statement specifying its intended use; and
- Any associated product packaging and promotional material must also be marked with the WaterMark trademark and licence number.

Although it is legal to sell and buy non-WaterMark certified plumbing products in Australia, if the product is not WaterMark certified, a licensed plumber is not permitted to install it.

All Con-Serv flow control devices are WaterMarked AS/NZS 2845.1 WMKA 02696; AS 5200.037.2 WMKA 00667; ATS 5200.012 WMKA 21148 or WMTS 479 WMK 25895.

To learn more about WaterMark certification, visit www.watermark.abcb.gov.au

Aerators

Aerators are found in most kitchen and bathroom outlets, and are a key component in the overall performance of the tap.

They work by:

- Controlling the water stream straightness and diameter;
- Reducing splash by aerating the stream and eliminating side spray; and
- Saving water, and reducing energy costs by restricting the flow rate.

Con-Serv Aerator inserts are available in Bubble Spray, Laminar and Stream Spray, and in a range of flow rates from as little as 2L/min. Con-Serv stock aerators in standard (21mm) and Tiny Man (15mm) sizes, in both male and female configurations.

See our full range of Aerators pages 42-44

Measuring Devices

There are many reasons why you might need to measure the water flow rate of your kitchen or bathroom taps and showers, particularly if you are replacing existing fittings or problem-solving potential water-waste culprits.

Checking your water flow rate is easy when you have the right tools – like Con-Serv’s Basin Water Flow Measuring Cup and Shower Flow Measuring Jug.

See our range of Measuring Devices on page 47.



Flow Control Valves

Con-Serv stock a range of flow control valves including Inline Flow Control Valves, Dual Check/Non-Return Valves and Flood Stop Valves. All Con-Serv flow control valves feature a constant flow regulator for guaranteed flow rate.

Inline Flow Control Valves

Inline flow controls connect directly to hose tails or compression nut with olive, fitting between connections where an end of line (outlet) fitting is not possible.

Dual Check Valves

Dual Check/Non-Return valves allows flow in one direction and automatically prevent backflow (reverse flow) from occurring when fluid in the line is drawn elsewhere.

Flood Stop Valves

The ¾" F&M brass flood stop valve prevent uncontrolled water flow from burst pressure hoses used for supply to domestic dish washing and washing machines. The safety valve will close and shut off the water when the flow is greater than 17L/min.

Con-Serv Flow Control Valves are available in a range of flow rates to suit a variety of situations.

See our range of Flow Control Valves pages 45-46.

Meter-Beater®

Meter-Beater® is a complete system that provides a new seat and seal mechanism with integral flow control for screw down taps and is flow controlled to regulate flow rate, reduce plumbing noise and to eliminate excess water use.

Meter-Beater® is exclusive to Con-Serv and is available in a variety of flow rates from as little as 2L/min. Meter-Beater® is WaterMarked AS 5200.037.2 WMKA 00667 and WELS rated as per licence number 0046.

See the Meter-Beater® range on page 47.

FLOW CONTROL

Aerators	42
Flow Valves	45
Control Valves, Regulators and Spigots	45
Dual Check/Non-Return Valves	46
Flood Stop Valves	46
Meter-Beater® Tap Components	47
Measuring Devices	47

FLOW CONTROL AERATORS

Aerators are a simple and effective way to help reduce your water usage while maintaining great pressure. Con-Serv has a extensive range to meet your needs. All Con-Serv aerators are WaterMarked AS 5200.037.2 WMKA 00667 and WELS rated as per licence number 0046.



	Code	Finish	Flow Rate	Without GST	With GST	Features
AERATOR INSERT - BUBBLE SPRAY						
	AF 5FVB	Grey	5 Star 6L/min	8.00	8.80	<ul style="list-style-type: none"> Bubble spray aerator flow valve insert WaterMark AS 5200.037.2 WMKA 00667 WELS licence number 0046
	AF 8FVB	Grey	3 Star 9L/min	8.00	8.80	
AERATOR INSERT - LAMINAR						
	AF 5FVL	Grey	5 Star 6L/min	8.00	8.80	<ul style="list-style-type: none"> Laminar flow valve insert Screenless WaterMark AS 5200.037.2 WMKA 00667 WELS licence number 0046
	AF 8FVL	Grey	3 Star 9L/min	8.00	8.80	
AERATOR INSERT - LAMINAR (ANTIMICROBIAL)						
	AF 5ALF	Grey	5 Star 6L/min	10.00	11.00	<ul style="list-style-type: none"> Laminar flow valve insert Antimicrobial additive reduces surface biofilm and bacteria build-up Antimicrobial protection Ag+ Plus WaterMark AS 5200.037.2 WMKA 00667 WELS licence number 0046
	AF 8ALF	Grey	3 Star 9L/min	10.00	11.00	
AERATOR INSERTS - LAMINAR (CLINIC COLOUR CODED)						
	AF 5CLL BE	Blue	5 Star 6L/min	8.00	8.80	<ul style="list-style-type: none"> Laminar (non-aerated), splash-free, crystal clear flow insert Colour coded to support a maintenance cycle WaterMark AS 5200.037.2 WMKA 00667 WELS licence number 0046
	AF 5CLL GR	Green	5 Star 6L/min	8.00	8.80	
	AF 5CLL RD	Red	5 Star 6L/min	8.00	8.80	
	AF 5CLL YE	Yellow	5 Star 6L/min	8.00	8.80	
AERATOR INSERT - STREAM SPRAY						
	AF 2FVS	Grey	6 Star 2L/min	8.00	8.80	<ul style="list-style-type: none"> Stream spray aerator flow valve insert WaterMark AS 5200.037.2 WMKA 00667 WELS licence number 0046
	AF 5FVS	Grey	5 Star 6L/min	8.00	8.80	
M15 AERATOR TINY MAN INSERT - BUBBLE SPRAY						
	AF 5TMB	Grey	5 Star 6L/min	7.00	7.70	<ul style="list-style-type: none"> 15mm bubble spray flow control aerator insert WaterMark AS 5200.037.2 WMKA 00667 WELS licence number 0046
	AF 8TMB	Grey	3 Star 9L/min	7.00	7.70	
M15 AERATOR TINY MAN INSERT - LAMINAR						
	AF 5TML	Grey	5 Star 6L/min	7.00	7.70	<ul style="list-style-type: none"> Laminar (non-aerated), splash-free, crystal clear flow insert Metric M15 size WaterMark AS 5200.037.2 WMKA 00667 WELS licence number 0046
M16 AERATOR (FEMALE) MINI VALVE - BUBBLE SPRAY						
	AF 15DFB C/05	Chrome	5 Star 6L/min	12.00	13.20	<ul style="list-style-type: none"> Female threaded bubble spray flow control aerator for metric 16mm male threaded spouts WaterMark AS 5200.037.2 WMKA 00667 WELS licence number 0046
	AF 15DFB C/08	Chrome	3 Star 9L/min	12.00	13.20	

FLOW CONTROL AERATORS

Aerators are a simple and effective way to help reduce your water usage while maintaining great pressure. Con-Serv has a extensive range to meet your needs. All Con-Serv aerators are WaterMarked AS 5200.037.2 WMKA 00667 and WELS rated as per licence number 0046.

	Code	Finish	Flow Rate	Without GST	With GST	Features
M18 AERATOR (MALE) MINI VALVE - LAMINAR						
	AF 15DMB C/05	Chrome	5 Star 6L/min	12.00	13.20	<ul style="list-style-type: none"> Female threaded bubble spray flow control aerator for metric 24 male threaded spouts WaterMark AS 5200.037.2 WMKA 00667 WELS licence number 0046
	AF 15DMB C/08	Chrome	3 Star 9L/min	12.00	13.20	
M22 AERATOR (FEMALE) - BUBBLE SPRAY						
	AF 22DFB C/05	Chrome	5 Star 6L/min	12.00	13.20	<ul style="list-style-type: none"> Female threaded bubble spray flow control aerator for metric 24 male threaded spouts WaterMark AS 5200.037.2 WMKA 00667 WELS licence number 0046
	AF 22DFB C/08	Chrome	3 Star 9L/min	12.00	13.20	
M22 AERATOR (FEMALE) - BUBBLE SPRAY (ANTI-VANDAL)						
	AF 22VFB C/05	Chrome	5 Star 6L/min	14.00	15.40	<ul style="list-style-type: none"> Female threaded bubble spray flow control aerator for metric 24 male threaded spouts For installation where vandalism is a consideration Anti-vandal fitting key supplied WaterMark AS 5200.037.2 WMKA 00667 WELS licence number 0046
	AF 22VFB C/08	Chrome	3 Star 9L/min	14.00	15.40	
M22 AERATOR (FEMALE) - LAMINAR						
	AF 22DFL C/05	Chrome	5 Star 6L/min	12.00	13.20	<ul style="list-style-type: none"> Female threaded laminar flow control aerator for metric 24 male threaded spouts WaterMark AS 5200.037.2 WMKA 00667 WELS licence number 0046
	AF 22DFL C/08	Chrome	3 Star 9L/min	12.00	13.20	
M22 AERATOR (FEMALE) - STREAM SPRAY						
	AF 22DFS C/02	Chrome	6 Star 2L/min	12.00	13.20	<ul style="list-style-type: none"> Female threaded stream spray flow control aerator for metric 24 male threaded spouts WaterMark AS 5200.037.2 WMKA 00667 WELS licence number 0046
	AF 22DFS C/05	Chrome	5 Star 6L/min	12.00	13.20	
M22 AERATOR (FEMALE) - STREAM SPRAY (ANTI-VANDAL)						
	AF 22VFS C/02	Chrome	6 Star 2L/min	14.00	15.40	<ul style="list-style-type: none"> Female threaded stream spray flow control aerator for metric 24 male threaded spouts For installation where vandalism is a consideration Anti-vandal fitting key supplied WaterMark AS 5200.037.2 WMKA 00667 WELS licence number 0046
	AF 22VFS C/05	Chrome	5 Star 6L/min	14.00	15.40	
M22 AERATOR (FEMALE) - SINK SWIVEL						
	AF 20 C	Chrome	3 Star 9L/min	41.00	45.10	<ul style="list-style-type: none"> Premium female sink spray aerator Metric 22 threaded brass ball joint for fitting to male thread outlet spouts Novodur P2MC natural ABS plastic housing For use with cold and hot water up to 85°C Adaptor supplied for male/female connection WaterMark AS 5200.037.2 WMKA 00667 WELS licence number 0046
M22 AERATOR (FEMALE) - ADAPTOR						
	AF 22F C/04	Chrome	6 Star 4.5L/min	6.00	6.60	<ul style="list-style-type: none"> DR brass female threaded aerator flow control adaptor for metric 22 female threaded aerators Fit to male threaded outlet spouts WaterMark AS 5200.037.2 WMKA 00667 WELS licence number 0046
	AF 22F C/06	Chrome	5 Star 6L/min	6.00	6.60	
	AF 22F C/09	Chrome	3 Star 9L/min	6.00	6.60	
	AF 22F C/12	Chrome	2 Star 12L/min	6.00	6.60	

FLOW CONTROL AERATORS

Aerators are a simple and effective way to help reduce your water usage while maintaining great pressure. Con-Serv has a extensive range to meet your needs. All Con-Serv aerators are WaterMarked AS 5200.037.2 WMKA 00667 and WELS rated as per licence number 0046.



	Code	Finish	Flow Rate	Without GST	With GST	Features
M24 AERATOR (MALE) - BUBBLE SPRAY						
	AF 24DMB C/05	Chrome	5 Star 6L/min	12.00	13.20	<ul style="list-style-type: none"> • Male threaded bubble spray flow control aerator for metric 22 female threaded spouts • WaterMark AS 5200.037.2 WMKA 00667 • WELS licence number 0046
	AF 24DMB C/08	Chrome	3 Star 9L/min	12.00	13.20	
M24 AERATOR (MALE) - BUBBLE SPRAY (ANTI-VANDAL)						
	AF 24VMB C/05	Chrome	5 Star 6L/min	14.00	15.40	<ul style="list-style-type: none"> • Male threaded bubble spray flow control aerator for metric 22 female threaded spouts • For installation where vandalism is a consideration • Anti-vandal fitting key supplied • WaterMark AS 5200.037.2 WMKA 00667 • WELS licence number 0046
	AF 24VMB C/08	Chrome	3 Star 9L/min	14.00	15.40	
M24 AERATOR (MALE) - LAMINAR						
	AF 24DML C/05	Chrome	5 Star 6L/min	12.00	13.20	<ul style="list-style-type: none"> • Male threaded laminar flow control aerator for metric 22 female threaded spouts • WaterMark AS 5200.037.2 WMKA 00667 • WELS licence number 0046
	AF 24DML C/08	Chrome	3 Star 9L/min	12.00	13.20	
M24 AERATOR (MALE) - STREAM SPRAY						
	AF 24DMS C/02	Chrome	6 Star 2L/min	12.00	13.20	<ul style="list-style-type: none"> • Male threaded stream spray flow control aerator for metric 22 female threaded spouts • WaterMark AS 5200.037.2 WMKA 00667 • WELS licence number 0046
	AF 24DMS C/05	Chrome	5 Star 6L/min	12.00	13.20	
M24 AERATOR (MALE) - STREAM SPRAY (ANTI-VANDAL)						
	AF 24VMS C/02	Chrome	6 Star 2L/min	14.00	15.40	<ul style="list-style-type: none"> • Male threaded stream spray flow control aerator for metric 22 female threaded spouts • For installation where vandalism is a consideration • Anti-vandal fitting key supplied • WaterMark AS 5200.037.2 WMKA 00667 • WELS licence number 0046
	AF 24VMS C/05	Chrome	5 Star 6L/min	14.00	15.40	
M24 AERATOR (MALE) - ADAPTOR						
	AF 24M C/04	Chrome	6 Star 4.5L/min	6.00	6.60	<ul style="list-style-type: none"> • DR brass male threaded aerator flow control adaptor for metric 24 male threaded aerators • Fit to female threaded outlet spouts • WaterMark AS 5200.037.2 WMKA 00667 • WELS licence number 0046
	AF 24M C/06	Chrome	5 Star 6L/min	6.00	6.60	
	AF 24M C/09	Chrome	3 Star 9L/min	6.00	6.60	
	AF 24M C/12	Chrome	2 Star 12L/min	6.00	6.60	
AERATOR UNIVERSAL SERVICE KEY						
	AF 00 UNK	Chrome		24.00	26.40	<ul style="list-style-type: none"> • Universal service key • Suitable for all standard aerator sizes • Metric Housings M18, M22, M24 and M28 • CACHE models TT, TJ, TF, JR and STD
AERATOR ANTI-VANDAL FITTING KEY						
	AF 00 VK	Stainless Steel		1.00	1.10	<ul style="list-style-type: none"> • Anti-vandal fitting key suits M22 Female and M24 Male housings

FLOW CONTROL FLOW VALVES

Designed to deliver a constant water flow, our range of all-purpose flow regulated valves are available in a range of finishes and flow rates, to suit every flow control situation. All Con-Serv flow valves are WaterMarked AS 5200.037.2 WMKA 00667 and WELS rated as per licence number 0046.

	Code	Finish	Flow Rate	Without GST	With GST	Features
BASIN FLOW CONTROL VALVE						
	AF 053 C/04	Chrome	6 Star 4.5L/min	19.00	20.90	<ul style="list-style-type: none"> • ½" M & F brass 35mm long constant flow regulator valve • ½" BSP female outlet • Designed to accept hose tails of compression nut and olive • WaterMark AS 5200.037.2 WMKA 00667 • WELS licence number 0046
	AF 053 C/06	Chrome	5 Star 6L/min	19.00	20.90	
	AF 053 C/09	Chrome	3 Star 9L/min	19.00	20.90	
	AF 053 C/12	Chrome	2 Star 12L/min	19.00	20.90	
FLANGE FLOW CONTROL VALVE						
	AF 055 C/02	Chrome	6 Star 2L/min	17.00	18.70	<ul style="list-style-type: none"> • ½" F & M DR brass sculptured flange • 35mm long x 57mm diameter constant flow regulator • ½" BSP female inlet and ½" BSP male outlet • WaterMark AS 5200.037.2 WMKA 00667 • WELS licence number 0046
	AF 055 C/04	Chrome	6 Star 4.5L/min	17.00	18.70	
	AF 055 C/06	Chrome	5 Star 6L/min	17.00	18.70	
	AF 055 C/09	Chrome	3 Star 9L/min	17.00	18.70	
FLOW CONTROL DISC						
	AF 019 B/06	Brass	5 Star 6L/min	12.00	13.20	<ul style="list-style-type: none"> • DR brass 19mm Flow control disc • WaterMark AS 5200.037.2 WMKA 00667 • WELS licence number 0046
	AF 019 B/09	Brass	3 Star 9L/min	12.00	13.20	
	AF 019 B/12	Brass	2 Star 12L/min	12.00	13.20	
FLOW CONTROL VALVE						
	AF 054 C/02	Chrome	6 Star 2L/min	20.00	22.00	<ul style="list-style-type: none"> • ½" F & M DR brass 35mm long flow regulator valve • ½" BSP female inlet, ½" BSP male outlet • Designed to accept hose tails or compression nut and olive • WaterMark AS 5200.037.2 WMKA 00667 • WELS licence number 0046
	AF 054 C/04	Chrome	6 Star 4.5L/min	20.00	22.00	
	AF 054 C/06	Chrome	5 Star 6L/min	20.00	22.00	
	AF 054 C/09	Chrome	3 Star 9L/min	20.00	22.00	
FLOW INTERCHANGE® SPIGOT ½"						
	AF 086 RB/06	Brass	6L/min	12.00	13.20	<ul style="list-style-type: none"> • Exclusive ½" DR brass outlet for connection to Con-Serv's bathroom water flow spigot body inlets • Eliminates damage to tiles and wall plates and aids alignment when installing shower bathroom products
	AF 086 RB/09	Brass	9L/min	12.00	13.20	
	AF 086 RB/12	Brass	12L/min	12.00	13.20	
	AF 086 RB/15	Brass	15L/min	12.00	13.20	
	AF 086 RB/FF	Brass	Full Flow	12.00	13.20	
M&F HOSE TAP FLOW REGULATOR ¾"						
	AF 059 C/06	Chrome	5 Star 6L/min	20.00	22.00	<ul style="list-style-type: none"> • ¾" M & F DR brass (20mm) hose cock flow regulator • Also suitable for use with water using appliances having ¾" BSP hose connections • Ideal for top-loading washing machines to limit flow when flood stop valves are installed • WaterMark AS 5200.037.2 WMKA 00667 • WELS licence number 0046
	AF 059 C/09	Chrome	3 Star 9L/min	20.00	22.00	
	AF 059 C/12	Chrome	2 Star 12L/min	20.00	22.00	
WHISPER WASH® - MK 1						
	AF 048 C/09	Chrome	9L/min	30.00	33.00	<ul style="list-style-type: none"> • ¾" F & M DR brass (20mm), 38mm long flow regulator non-return valve • For appliance noise reduction • Suitable for washing machines, dishwashers and all water-using appliances with ¾" BSP hose connections • WaterMark AS 5200.037.2 WMKA 00667

Protect your home or business with our Dual Check/Non-return and Flood Stop valves. Suitable for both domestic and commercial environments. All Con-Serv valves are WaterMarked AS 5200.037.2 WMKA 00667 and WELS rated as per licence number 0046.



Code	Finish	Flow Rate	Without GST	With GST	Features
------	--------	-----------	-------------	----------	----------

DUAL CHECK / NON-RETURN VALVES

DUAL CHECK/NON-RETURN 1/2" M&F



DC 042 C/04	Chrome	6 Star 4.5L/min	23.00	25.30
DC 042 C/06	Chrome	5 Star 6L/min	23.00	25.30
DC 042 C/09	Chrome	3 Star 9L/min	23.00	25.30
DC 042 C/12	Chrome	2 Star 12L/min	23.00	25.30
DC 042 C/FF	Chrome	Full Flow	23.00	25.30

- 1/2" BSP male inlet; 1/2" BSP female outlet
- Designed to accept compression nut and olive
- Operating temperature 1° - 60° Celsius
- Max. working pressure 1200 kPa for Full Flow
- Recommended working pressure 150-500 kPa
- Independently operating check valves
- Suitable for low hazard applications
- WaterMarked AS 5200.037.2 WMKA 00667 (Dual Check Flow Control) and AS/NZS 2845.1, Licence WMKA 02696 (Backflow Prevention Device)
- WELS licence number 0046

DUAL CHECK/NON-RETURN 1/2" F&M



BRUSHED NICKEL				
DC 043 BN/04	Brushed Nickel	6 Star 4.5L/min	50.00	55.00
DC 043 BN/06	Brushed Nickel	5 Star 6L/min	50.00	55.00
DC 043 BN/09	Brushed Nickel	3 Star 9L/min	50.00	55.00
DC 043 BN/12	Brushed Nickel	2 Star 12L/min	50.00	55.00
DC 043 BN/FF	Brushed Nickel	Full Flow	50.00	55.00
CHROME				
DC 043 C/04	Chrome	6 Star 4.5L/min	23.00	25.30
DC 043 C/06	Chrome	5 Star 6L/min	23.00	25.30
DC 043 C/09	Chrome	3 Star 9L/min	23.00	25.30
DC 043 C/12	Chrome	2 Star 12L/min	23.00	25.30
DC 043 C/FF	Chrome	Full Flow	23.00	25.30
MATTE BLACK				
DC 043 MB/04	Matte Black	6 Star 4.5L/min	50.00	55.00
DC 043 MB/06	Matte Black	5 Star 6L/min	50.00	55.00
DC 043 MB/09	Matte Black	3 Star 9L/min	50.00	55.00
DC 043 MB/12	Matte Black	2 Star 12L/min	50.00	55.00
DC 043 MB/FF	Matte Black	Full Flow	50.00	55.00

- 1/2" BSP female inlet; 1/2" BSP male outlet
- Designed to accept compression nut and olive
- Operating temperature 1° - 60° Celsius
- Max. working pressure 1200 kPa for Full Flow
- Recommended working pressure 150-500 kPa
- Independently operating check valves
- Suitable for low hazard applications
- WaterMarked AS 5200.037.2 WMKA 00667 (Dual Check Flow Control) and AS/NZS 2845.1, Licence WMKA 02696 (Backflow Prevention Device)
- WELS licence number 0046

DUAL CHECK/NON-RETURN 1/2" M&M



DC 057 C/04	Chrome	6 Star 4.5L/min	15.00	16.50
DC 057 C/06	Chrome	5 Star 6L/min	15.00	16.50
DC 057 C/09	Chrome	3 Star 9L/min	15.00	16.50
DC 057 C/12	Chrome	2 Star 12L/min	15.00	16.50
DC 057 C/FF	Chrome	Full Flow	15.00	16.50

- R 1/2" male inlet; R 1/2" male outlet
- Operating temperature 1° - 60° Celsius
- Max. working pressure 1200 kPa for Full Flow
- Recommended working range 150-500 kPa
- Independently operating check valves
- Suitable for low hazard applications
- WaterMarked AS 5200.037.2 WMKA 00667 (Dual Check Flow Control) and AS/NZS 2845.1, Licence WMKA 02696 (Backflow Prevention Device)
- WELS licence number 0046

FLOOD STOP VALVES

FLOOD STOP VALVE



FS 038 C	Chrome	N/A	31.00	34.10

- 3/4" F & M DR brass
- Prevents the uncontrolled water flow from burst hoses used for dishwashing and front load washing machines
- The safety valve will close and shut off the water when the flow is greater than 17L/min
- Minimum operating pressure 200 kPa static
- Maximum operating pressure 500 kPa static
- WaterMark WMTS 479 WMK 25895

FLOW CONTROL METER-BEATER® AND MEASURING DEVICES



Exclusive to Con-Serv, Meter-Beater® is a complete system that provides a new seat and seal mechanism with integral flow control for screw down taps to regulate flow rate and eliminate excess water use. Meter-Beater® is WaterMarked AS 5200.037.2 WMKA 00667 and WELS rated as per licence number 0046.

Code	Finish	Without GST	With GST	Features
------	--------	-------------	----------	----------

METER-BEATER® TAP COMPONENTS

METER-BEATER® ½" CERAMIC DISC TAPWARE						
	MB 047/02	6 Star 2L/min	14.00	15.40	<ul style="list-style-type: none"> • Flow controlled DR brass valve • Seat insert 9/16th brass thread • 8mm hexagonal core • Suits ¼", ½" & ¾" turn ceramic disc tapware • WaterMark AS 5200.037.2 WMKA 00667 • WELS licence number 0046 	
	MB 047/04	6 Star 4.5L/min	14.00	15.40		
	MB 047/06	5 Star 6L/min	14.00	15.40		
	MB 047/09	3 Star 9L/min	14.00	15.40		
	MB 047/12	2 Star 12L/min	14.00	15.40		
METER-BEATER® ½" SCREW DOWN TAPWARE						
	MB 045/02	6 Star 2L/min	14.00	15.40	<ul style="list-style-type: none"> • For screw down tapware • Flow controlled DR brass valve • Seat insert 9/16th brass thread • 8mm hexagonal core, nitril rubber seal • Saves hot and cold water • Reduces plumbing noise • WaterMark AS 5200.037.2 WMKA 00667 • WELS licence number 0046 	
	MB 045/04	6 Star 4.5L/min	14.00	15.40		
	MB 045/06	5 Star 6L/min	14.00	15.40		
	MB 045/09	3 Star 9L/min	14.00	15.40		
	MB 045/12	2 Star 12L/min	14.00	15.40		
METER-BEATER® VALVE BODY O-RING SEAL						
	MB 045 OR01	Single	0.50	0.55	<ul style="list-style-type: none"> • Valve body nitril 70 O-ring seal for Meter-Beater® • Available in singles or packs of 10 or 20 	
	MB 045 OR10	10 Pack	4.00	4.40		
	MB 045 OR20	20 Pack	7.00	7.70		
METER-BEATER® INSTALLATION KIT						
	MB 043 IK	Pack	20.00	22.00	<ul style="list-style-type: none"> • Installation Kit Includes: - 9/16" tapping tool - Tapping tool guide - 8mm Allen key - Spindle flush plug 	
	METER-BEATER® INSTALLATION TOOLS					
	MB 043 RT	Chrome	15.00	16.50		Meter-Beater® Reamer Tool
	MB 043 FP	Chrome	4.00	4.40		Meter-Beater® Spindle Flush Plug
MB 043 TT	Chrome	15.00	16.50	Meter-Beater® Tapping Tool		

MEASURING DEVICES

BASIN FLOW MEASURING CUP					
	FM 070 BE	Blue	16.00	17.60	<ul style="list-style-type: none"> • Measures flow rate from tapware • Test range 3L/min to 20L/min • Instructions available on the Con-Serv website, or scan QR code for more information
SHOWER FLOW MEASURING JUG					
	FM 075 BE	Blue	18.00	19.80	<ul style="list-style-type: none"> • Measures flow rate from showers • Test range 4.5L/min to 24L/min • Instructions available on the Con-Serv website, or scan QR code for more information





Safe-Assist Healthcare

Skills combined with innovative techniques and leading designs establish the enduring character for which Con-Serv is known. With 40 years' industry experience, Con-Serv has long been recognised as a leader in the healthcare industry with its Safe-Assist range of grab rails, toilet aids, accessible showers, folding shower seats, anti-ligature, bariatric and antimicrobial bathroom products. Whether you are looking for support rails for independent living installations, or something on a larger scale, Con-Serv have a range of domestic and commercial healthcare solutions to meet your needs.

Grab Rails

A grab rail is a safety device designed to enable users to maintain their balance, reduce fatigue while standing, and support users weight when moving between two places. They are commonly installed in high risk areas such as bathrooms to reduce the possibility of slipping or falling.

Designs for every style and budget

Whether you want the sophistication of a Linear rail, the hygienic benefits of an antimicrobial seal, or the affordability of a traditional clam flange, Con-Serv have the grab rail to suit your needs. Choose your profile preference and view our range of grab rails and healthcare showers.

All Con-Serv grab rails are fabricated from 32mm grade 304,18/8 stainless steel and are supported by Con-Serv's 20 year domestic and 7 year commercial warranty.

The advantages of stainless steel grab rails

- **Corrosion, scratch and stain resistant.** Stainless steel contains a natural passive, chromium-rich, oxide film that forms on the surface of the steel. This invisible shield is self-renewing and acts as a protectant against corrosion and damage.
- **Easy to clean.** Stainless steel is non-porous and easy to clean. Never use chlorides, acids or steel wool. Simply wipe over the surface using a mild detergent or ammonia solution with a soft cloth for a perfect finish.
- **Durability.** Stainless steel is strong and easy to work with making it a cost effective and durable solution for grab rail manufacturing.

Grab rail profiles

Con-Serv grab rails are available in three standard profiles in addition to our specialty anti-ligature and bariatric grab rails. Each profile collection includes options for straight, accessible and shower recess grab rails in a range of sizes and finishes.



Clam® Flange

Our traditional Clam® Flange grab rail with standard 78mm domed flange cover.



Hygienic Seal®

Our premium grab rail with minimalist 50mm screw on flange cover featuring Biomaster Thermoplastic Elastomer seals.



Linear

Our Linear range, combines our Hygienic Seal® flange with a "T" leg linear flange for a stylish design ideal for all applications.

Grab Rail Showers

Con-Serv Healthcare Showers are a result of 40 years' designing innovative solutions for individuals that need extra assistance. Our Healthcare Shower Kits utilise our industry leading grab rails, combined with our custom designed sliders and water saving handpieces for a AS 1428.1:2021 compliant solution suitable for home and commercial applications.

Shower Sliders

Con-Serv offer a variety of sliders with handset options to meet independent needs. Choose from our Glide Slide with Clicklock™ cradle, Friction Slider for users with weakened arthritis grip, and our Push-PullMe® slider with rod for seated users, for a custom shower combination.

Shower Seats

When safety in the shower is paramount, Con-Serv shower seats are the industry recognised solution with rounded, smooth edges and seats that are foldable, self-draining and non-slip. Manufactured from grade 304 stainless steel, with High Density Polyethylene (HDPE) seat top and assembled with anti-drop tension hinges ensuring stability up to 160kg for our standard shower seats, and up to 400kg for our Bariatric shower seat.

[See our full range of Shower Seats pages 88-89.](#)

Anti-Ligature

Specially designed Anti-Ligature grab rails for use in bathrooms and accessible areas to mitigate the possibility of self-harm by patients in psychiatric clinics, hospitals and detention facilities.

Our fixed Anti-Ligature grab rails incorporate a 2.5mm grade 304 stainless steel plate centred 55mm from the back of the rail to wall, and continuously welded from flange to flange enabling secure rail access that is free of ligature points.

Our Anti-Ligature range also features a fixed wall shower and grab rail shower options with an anti-ligature slider and elbow.

[See our full range of Aerators pages 50-51.](#)

Antimicrobial "Active against microbes"

In developing our Antimicrobial range, antimicrobial additives have been infused into the product material during the manufacturing process. These additives work to attack the bacteria cell wall, interrupt cell metabolism and prevent bacteria reproduction extending the products hygienic properties and minimising the potential of cross-contamination.

Biomaster protected

Biomaster is a recognised leader of antimicrobial technology for plastics, fabrics and coatings. Look for the Biomaster symbol on our range.



[See our Antimicrobial range on pages 52-53.](#)

Bariatric

Bariatric healthcare specialises in serving and supporting users over 120kg to ensure a safe and accessible environment. Our bariatric range include increased weight capacities with additional support to meet the requirements of bariatric patients in areas such as toilets and showers.

The Con-Serv Bariatric range includes, Grab Rails, Folding Grab Rails, Grab Rail Showers and Shower Seats.

[See our full Bariatric range pages 56-59.](#)

AS 1428.1 Kits

In support of the 2021 release of the Australian Standards AS 1428.1:2021 Design for Access and Mobility, Con-Serv have developed a series of Combination Kits that meet needs for Accessible Sanitary Facilities, Accessible Shower Recess, Accessible Combined Sanitary Facilities (Section 12) and Ambulant Accessible Sanitary Compartments (Section 13).

[See our AS 1428.1 Combination Kits pages 102-109.](#)

SAFE-ASSIST HEALTHCARE

Anti-Ligature Collection	50
Antimicrobial Collection	52
Backrests - Accessible Toilet Assist	54
Bariatric Collection	56
Clam® Flange Collection	60
Hygienic Seal® Collection	66
Linear Collection.....	80
Shower Seats	88
Folding, Swing and Floor/Wall Grab Rails	90
Spare Parts and Accessories	92
AS 1428.1:2021 Combination Kits	102









Anti-Ligature Collection

	Code	Finish	GST Exempt	Features		
ANTI-LIGATURE VERTICAL GRAB RAILS						
	450MM			<ul style="list-style-type: none"> • 450mm, 600mm, 900mm and 1200mm, centre to centre • Vertical design for WC's and accessible areas in psychiatric clinics, hospitals and detention facilities • Mitigates the possibility of self-harm by patients • 2.5mm barrier plate featuring continuous weld • Fabricated from 38mm 304 stainless steel • Exposed fixings • Tamper resistant hex socket Post Torx screws supplied • Generally meets the requirements of AS 1428.1:2021 Design for access and mobility 		
	AL 450 AW VL	Antimicrobial White	210.00			
	AL 450 BS VL	Brushed Stainless	180.00			
	600MM					
	AL 600 AW VL	Antimicrobial White	270.00			
	AL 600 BS VL	Brushed Stainless	240.00			
	900MM					
	AL 900 AW VL	Antimicrobial White	300.00			
	AL 900 BS VL	Brushed Stainless	270.00			
	1200MM					
	AL 1200 AW VL	Antimicrobial White	330.00			
	AL 1200 BS VL	Brushed Stainless	300.00			
ANTI-LIGATURE HORIZONTAL GRAB RAILS						
	450MM			<ul style="list-style-type: none"> • 450mm, 600mm, 900mm and 1200mm, centre to centre • Horizontal design for WC's and accessible areas in psychiatric clinics, hospitals, and detention facilities • Mitigates the possibility of self-harm by patients • Unique open-end trough design makes cleaning easy • Fabricated from 38mm 304 stainless steel • Exposed fixings • Tamper resistant hex socket POST TORX screws supplied • Generally meets the requirements of AS 1428.1:2021 Design for access and mobility 		
	AL 450 AW HZ LH	Antimicrobial White	380.00			
	AL 450 AW HZ RH	Antimicrobial White	380.00			
	AL 450 BS HZ LH	Brushed Stainless	300.00			
	AL 450 BS HZ RH	Brushed Stainless	300.00			
	600MM					
	AL 600 AW HZ LH	Antimicrobial White	430.00			
	AL 600 AW HZ RH	Antimicrobial White	430.00			
	AL 600 BS HZ LH	Brushed Stainless	350.00			
	AL 600 BS HZ RH	Brushed Stainless	350.00			
	900MM					
	AL 900 AW HZ LH	Antimicrobial White	530.00			
	AL 900 AW HZ RH	Antimicrobial White	530.00			
	AL 900 BS HZ LH	Brushed Stainless	450.00			
	AL 900 BS HZ RH	Brushed Stainless	450.00			
	1200MM					
	AL 1200 AW HZ LH	Antimicrobial White	630.00			
	AL 1200 AW HZ RH	Antimicrobial White	630.00			
	AL 1200 BS HZ LH	Brushed Stainless	550.00			
	AL 1200 BS HZ RH	Brushed Stainless	550.00			
	ANTI-LIGATURE 90° AMBULANT AND ACCESSIBLE GRAB RAILS 450MM X 450MM					
	For ambulant disabilities	AL 454 AW LH	Antimicrobial White		570.00	<ul style="list-style-type: none"> • 450mm x 450mm Anti-Ligature Toilet Assist Grab Rail • For use in WC's and other accessible areas in psychiatric clinics, hospitals and detention facilities • Mitigates the possibility of self-harm by patients • Unique open end trough design makes cleaning easy • Fabricated from 38mm 304 stainless steel • Exposed fixings • Tamper resistant hex socket POST TORX screws supplied • Generally meets the requirements of AS 1428.1:2021 Design for access and mobility
		AL 454 AW RH	Antimicrobial White		570.00	
		AL 454 BS LH	Brushed Stainless		450.00	
	AL 454 BS RH	Brushed Stainless	450.00			
ANTI-LIGATURE 90° AMBULANT AND ACCESSIBLE GRAB RAILS 960MM X 600MM						
For ambulant disabilities	AL 966 AW LH	Antimicrobial White	800.00	<ul style="list-style-type: none"> • 960mm x 600mm Anti-Ligature Toilet Assist Grab Rail • For use in WC's and other accessible areas in psychiatric clinics, hospitals, and detention facilities • Mitigates the possibility of self-harm by patients • Unique open end trough design makes cleaning easy • Fabricated from 38mm 304 stainless steel • Exposed fixings • Tamper resistant hex socket POST TORX screws supplied • Generally meets the requirements of AS 1428.1:2021 Design for access and mobility 		
	AL 966 AW RH	Antimicrobial White	800.00			
	AL 966 BS LH	Brushed Stainless	650.00			
	AL 966 BS RH	Brushed Stainless	650.00			



ANTI-LIGATURE COLLECTION SHOWER KITS

Specially designed 38mm Anti-Ligature grab rails with barrier for use in accessible areas to mitigate the possibility of self-harm by patients in hospitals, psychiatric clinics and detention facilities. Generally meets the requirements of AS 1428.1:2021 Design for access and mobility.

	Code	Finish	Without GST	With GST	Features
ANTI-LIGATURE SHOWER KIT 6					
 <p>Load Sensitive Handset Cradle</p> <p>Elbow with Force Release Mechanism</p> <p>Grab Rail not included</p>	AL 01806 AW	Antimicrobial White	195.00	Exempt	<ul style="list-style-type: none"> White Acetal 38mm load sensitive handset cradle for shower support and height adjustment ABS chrome Hosfcare® single function shower with full pattern spray and rub-clean spray diffuser PVC 1500mm hose with ½" BSP swivel conical nut Chrome DR Brass anti-ligature wall outlet elbow featuring force release mechanism when 10kg of weight is applied Licensed dual check/non-return as per WaterMark AS/NZS 2845.1 WMKA 02696 WaterMark AS 3662 WMKT 21147 Available in 3 Star 9L/min and 4 Star 6.5L/min as per WELS licence number 0046 Grab rail not included   <p>Load Sensitive Handset Cradle HC 038</p>
	AL 01806 AW/6.5	Antimicrobial White	195.00	Exempt	
	AL 01806 C	Chrome	210.00	Exempt	
	AL 01806 C/6.5	Chrome	210.00	Exempt	
ANTI-LIGATURE SHOWER KIT 9					
 <p>Load Sensitive Handset Cradle</p> <p>Elbow with Force Release Mechanism</p>	AL 01809 AW	Antimicrobial White	495.00	Exempt	<ul style="list-style-type: none"> Anti-Ligature 900mm grab rail White Acetal 38mm load sensitive handset cradle for shower support and height adjustment ABS chrome® single function shower with full pattern spray and rub-clean spray diffuser PVC 1500mm hose with ½" BSP swivel conical nut Licensed dual check/non-return as per WaterMark AS/NZS 2845.1 WMKA 02696 Chrome DR Brass anti-ligature wall outlet elbow featuring force release mechanism when 10kg of weight is applied WaterMark AS 3662 WMKT 21147 Available in 3 Star 9L/min and 4 Star 6.5L/min as per WELS licence number 0046   <p>Load Sensitive Handset Cradle HC 038</p>  <p>Security hex socket</p>
	AL 01809 AW/6.5	Antimicrobial White	495.00	Exempt	
	AL 01809 C	Chrome	480.00	Exempt	
	AL 01809 C/6.5	Chrome	480.00	Exempt	
COBRA ANTI-LIGATURE / VANDAL RESISTANT SHOWER					
	CS 007 C	Chrome	105.00	115.50	<ul style="list-style-type: none"> Vandal resistant/Anti-ligature design 17° angle design, free from ligature points and attached with grub screws for tamper resistant installation Brass 59mm shower body 316 stainless steel (marine grade) 27mm jet spray diffuser Flow Interchange® spigot Full pattern spray Maximum spray projection 940mm from 1850mm height Ideal for correctional, mental health and rehabilitation centres WaterMark AS 3662 WMKT 21147 Available in 3 Star 9L/min and 4 Star 6.5L/min as per WELS licence number 0046 
	CS 007 C/6.5	Chrome	105.00	115.50	

Antimicrobial Collection



Biomaster Thermoplastic Elastomer seals for added protection against bacteria

	Code	Finish	Without GST	With GST	Features
ANTIMICROBIAL AERATOR INSERTS					
	WELS 5 STAR 6L/MIN				<ul style="list-style-type: none"> Laminar flow valve insert Antimicrobial additive reduces surface biofilm and bacteria build-up Antimicrobial protection Ag+ Plus WaterMark AS 5200.037.2 WMKA 00667 Available in 3 Star 9L/min and 5 Star 6L/min as per WELS licence number 0046
	AF 5ALF	Grey - 6L/min	10.00	11.00	
	WELS 3 STAR 9L/MIN				
	AF 8ALF	Grey - 9L/min	10.00	11.00	
ANTIMICROBIAL HANDSET CRADLE					
	HC 024 AW	Antimicrobial White	42.00	Exempt	<ul style="list-style-type: none"> ABS handset cradle for 32mm grab rail Clicklock™ claw mechanism for tilt angle ABS construction with Biomaster antimicrobial additive White body, handset cradle, and lock nut
ANTIMICROBIAL HOSCAR® HANDPIECE					
	HP 030 AW	Antimicrobial White	35.00	38.50	<ul style="list-style-type: none"> ABS 100mm single function shower with Biomaster antimicrobial additive Concentric full pattern spray Rub-clean spray diffuser WaterMark AS 3662 WMKT 21147 
ANTIMICROBIAL HOSES					
	SH 0900 AW	Antimicrobial White	39.00	42.90	<ul style="list-style-type: none"> 900mm, 1200mm, 1500mm, 2000mm, 3000mm and 4000mm hose lengths Antimicrobial hose with chrome plated brass end nuts Inner layer made from black TPE with Biomaster antimicrobial additive Outer layer is non-phthalate flexible PVC with Biomaster antimicrobial additive Smooth PVC hose with elastic inner strengthened by 1000 denier high tenacity polyester cord 1 x 1/2" BSP swivel and 1 x 1/2" BSP fixed conical end nuts Meets the performance requirements of AS/NZS 3662 clause 5.4
	SH 1200 AW	Antimicrobial White	42.00	46.20	
	SH 1500 AW	Antimicrobial White	45.00	49.50	
	SH 2000 AW	Antimicrobial White	50.00	55.00	
	SH 3000 AW	Antimicrobial White	60.00	66.00	
	SH 4000 AW	Antimicrobial White	70.00	77.00	
ANTIMICROBIAL FOLDING SHOWER SEAT					
	SS 964 AW ME	Antimicrobial White	1150.00	Exempt	<ul style="list-style-type: none"> Seat size: 960mm x 400mm Antimicrobial slatted seat deck AS 1428.1:2021 compliant Seat features self draining channels Maximum load 250kg Stainless steel fixing screws supplied  

ANTIMICROBIAL COLLECTION SHOWER KITS

Highly effective against most common types of pathogenic bacteria, antimicrobial additives are infused into product during the manufacturing process inhibiting the growth of bacteria and microbes on surfaces, fabrics and coatings by up to 99.9%.



Learn more about our
Antimicrobial® range

	Code	Finish	GST Exempt	Features	
ANTIMICROBIAL SHOWER KIT 6					
<p>Grab Rail not included</p>	1500MM ANTIMICROBIAL HOSE			<ul style="list-style-type: none"> • Antimicrobial ABS Glide Slide cradle • Antimicrobial Hoscare® handpiece • Antimicrobial PVC shower hose • DR brass wall outlet elbow • 57mm solid brass round flat flange • Flow Interchange® spigot • Licenced dual check/non-return as per WaterMark AS/NZS 2845.1 WMKA 02696 • WaterMark AS 3662 WMKT 21147 • Available in 3 Star 9L/min and 4 Star 6.5L/min as per WELS licence number 0046 	
	HS 01806 AW	Antimicrobial White	188.00		Exempt
	HS 01806 AW/6.5	Antimicrobial White	188.00		Exempt
	2000MM ANTIMICROBIAL HOSE				
	HS 01806 AW2	Antimicrobial White	193.00		Exempt
	HS 01806 AW2/6.5	Antimicrobial White	193.00		Exempt
ANTIMICROBIAL SHOWER KIT 12					
	1500MM ANTIMICROBIAL HOSE			<ul style="list-style-type: none"> • Antimicrobial Hoscare® handpiece • Antimicrobial hose with ½" BSP swivel conical end nut • DR brass wall outlet elbow with flow Interchange® spigot • Brass 57mm wall flange • Licenced dual check/non-return as per WaterMark AS/NZS 2845.1 WMKA 02696 • WaterMark AS/NZS 3662 WMKT 21147 • Available in 3 Star 9L/min and 4 Star 6.5L/min as per WELS licence number 0046 	
	HS 01812 AW	Antimicrobial White	146.00		160.60
	HS 01812 AW/6.5	Antimicrobial White	146.00		160.60
	2000MM ANTIMICROBIAL HOSE				
	HS 01812 AW2	Antimicrobial White	151.00		166.10
	HS 01812 AW2/6.5	Antimicrobial White	151.00		166.10
ANTIMICROBIAL SHOWER					
	1500MM ANTIMICROBIAL HOSE			<ul style="list-style-type: none"> • 900mm Hygienic Seal® grab rail with Biomaster TPE seals • Antimicrobial ABS Glide Slide cradle (HC 024 AW) • Antimicrobial Hoscare® handpiece (HP 030 AW) • Antimicrobial PVC shower hose (SH 1500 AW) • Chrome plated DR brass wall outlet elbow • Flow Interchange® spigot • Licenced dual check/non-return as per WaterMark AS/NZS 2845.1 WMKA 02696 • 57mm solid brass round flat flange • Full pattern spray • WaterMark AS 3662 WMKT 21147 • Available in 3 Star 9L/min and 4 Star 6.5L/min as per WELS licence number 0046 <p>Options available on request</p> <ul style="list-style-type: none"> • ABS Grab Rail Soap Dish Holder - see page 94 	
	HS 01809 AW	Antimicrobial White	323.00		Exempt
	HS 01809 AW/6.5	Antimicrobial White	323.00		Exempt
	2000MM ANTIMICROBIAL HOSE				
	HS 01809 AW2	Antimicrobial White	328.00		Exempt
	HS 01809 AW2/6.5	Antimicrobial White	328.00		Exempt

Model shown: HS 01809 AW

Backrests - Accessible Toilet Assist



Code Finish GST Exempt Features

FLOOR MOUNTED BACKRESTS

BR 395 BS	Brushed Stainless	435.00
BR 395 PS	Polish Supreme™	510.00



- WC support device for disabled, aged and the infirmed
- Suits all standard accessible suites with conventional pans (not wall faced)
- Suits single accessible cubicle or combined accessible compartment featuring WC and shower recess grab rail
- Polar White UV stabilised HDPE rounded edge back support
- 78mm pre-formed domed Clam® Flange
- Fabricated from 32mm 304 stainless steel
- Stainless steel fixing screws supplied
- Patent Number 2010100132
- Meets the requirements of AS 1428.1:2021 Design for access and mobility

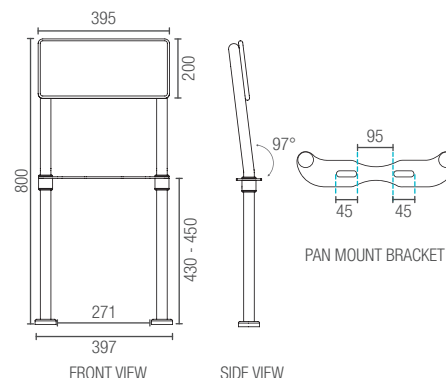

WALL MOUNTED BACKRESTS

A. Clam® Flange



CLAM® FLANGE BACKRESTS (A)		
BR 400 BS CF	Brushed Stainless	400.00
BR 400 PS CF	Polish Supreme™	445.00

B. Hygienic Seal®







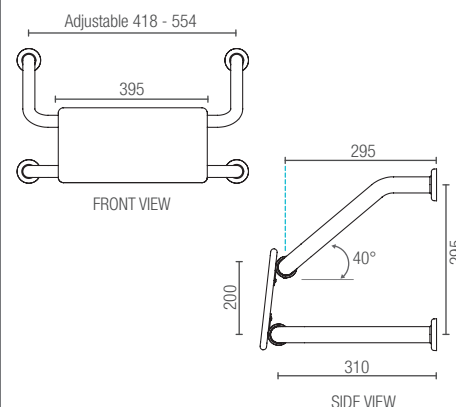



HYGIENIC SEAL® BACKRESTS (B)		
BR 400 BS HS	Brushed Stainless	420.00
BR 400 MB HS	Matte Black	540.00
BR 400 PS HS	Polish Supreme™	465.00
BR 400 WT HS	White	540.00

- WC support device for disabled, aged and the infirmed
- Suits single accessible cubicle or combined accessible compartment featuring WC and shower recess grab rail
- Polar White UV stabilised HDPE rounded edge back support
- Fabricated from 32mm 304 stainless steel
- Stainless steel fixing screws supplied
- Patent Number 2010101409
- Complies with section 12.2.4 of AS 1428.1:2021 for sanitary facilities

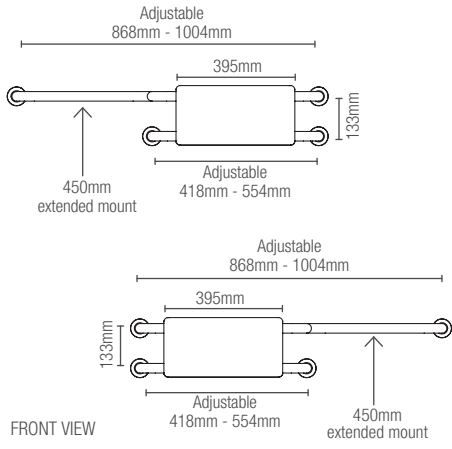

BACKRESTS ACCESSIBLE TOILET ASSIST

Robust 32mm grade 304 stainless steel backrests fabricated with a choice mounting options. Con-Serv Backrests feature a 96° inclined, tamper resistant, sanitary safe, UV stabilised HDPE back support and meets the requirements of Section 12.2.4 Backrest of AS 1428.1:2021.

	Code	Finish	GST Exempt	Features	
WALL MOUNTED BACKRESTS WITH EXTENSION					
A. Clam® Flange 	CLAM® FLANGE EXTENDED BACKRESTS (A)			<ul style="list-style-type: none"> • WC support device for disabled, aged and the infirmed • Suits single accessible cubicle with either conventional or wall faced pans • 450mm reversible side extension • Polar White UV stabilised HDPE rounded edge back support • Fabricated from 32mm 304 stainless steel • Stainless steel fixing screws supplied • Patent Number 2010101409 • Complies with section 12.2.4 of AS 1428.1:2021 for sanitary facilities  	
	BR 440 BS CF	Brushed Stainless	415.00		
BR 440 PS CF	Polish Supreme™	465.00			
B. Hygienic Seal® 	HYGIENIC SEAL® EXTENDED BACKRESTS (B)				
	BR 440 BS HS	Brushed Stainless	430.00		
	BR 440 MB HS	Matte Black	590.00		
	BR 440 PS HS	Polish Supreme™	585.00		
BR 440 WT HS	White	590.00			
WALL MOUNTED BACKRESTS WITH HIDEAWAY™ MOUNTING SYSTEM					
A. 	HYGIENIC SEAL® BACKRESTS (A)				<ul style="list-style-type: none"> • WC support device for disabled, aged and the infirmed • Hideaway™ End Flanges (4) • Polar White UV stabilised HDPE rounded edge back support • Fabricated from 32mm 304 stainless steel • Stainless steel fixing screws supplied • Patent Number 2010101409 • Complies with section 12.2.4 of AS 1428.1:2021 for sanitary facilities 
	BR 404 MB HS	Matte Black	696.00		
BR 404 PS HS	Polish Supreme™	597.00			
B. 	HYGIENIC SEAL® EXTENDED BACKRESTS (B)				
	BR 444 MB HS	Matte Black	746.00		
BR 444 PS HS	Polish Supreme™	617.00			
 					

All dimensions are in millimetres unless otherwise specified.

Bariatric Collection



Code Finish GST Exempt Features

BARIATRIC STRAIGHT GRAB RAILS

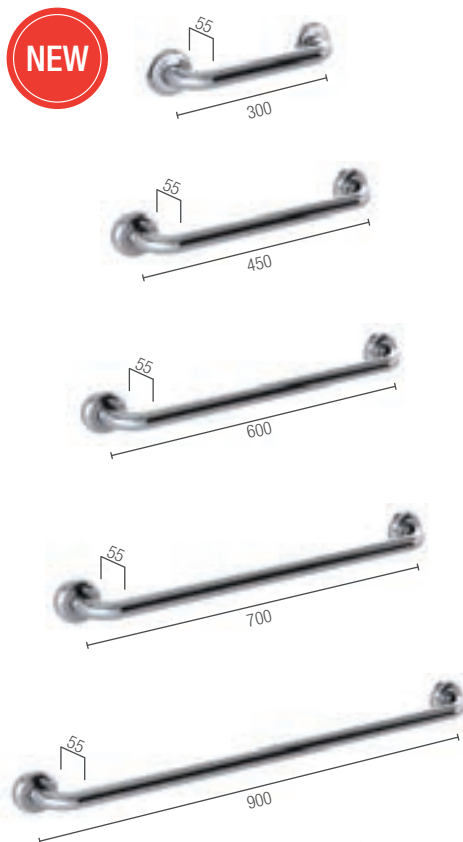

LOAD RATED TO 400KG

300MM		
BG 300 BS	Brushed Stainless	100.00
BG 300 PS	Polish Supreme™	120.00
450MM		
BG 450 BS	Brushed Stainless	120.00
BG 450 PS	Polish Supreme™	140.00
600MM		
BG 600 BS	Brushed Stainless	130.00
BG 600 PS	Polish Supreme™	150.00
700MM		
BG 700 BS	Brushed Stainless	140.00
BG 700 PS	Polish Supreme™	165.00
900MM		
BG 900 BS	Brushed Stainless	150.00
BG 900 PS	Polish Supreme™	180.00

- 300mm, 450mm, 600mm, 700mm and 900mm, centre to centre
- 32mm rail fabricated from 304 stainless steel with 3.0mm wall thickness
- 78mm pre-formed domed Clam® Flange
- Wall clearance 55mm
- Stainless steel fixings screws supplied
- Meets the requirements of AS 1428.1:2021 Design for access and mobility
- Tested by QTL to 400kg (test report 203703 9236 - 06/02/2020)



Options available on request

- Welded Toilet Paper Holder (Factory Fitted) - see page 92
- Shower kits - see pages 96-101

BARIATRIC SHOWER RECESS INVERTED "T" GRAB RAILS 700MM X 1100MM

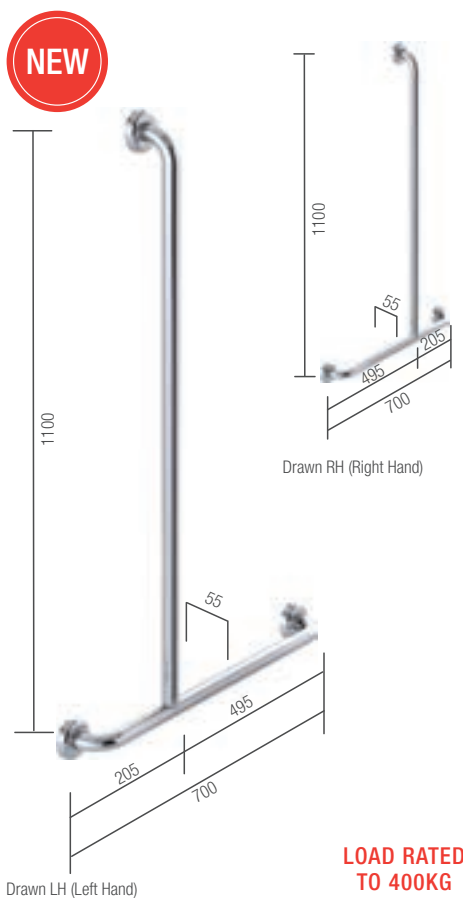

LOAD RATED TO 400KG

BG 071 BS LH	Brushed Stainless	310.00
BG 071 BS RH	Brushed Stainless	310.00
BG 071 PS LH	Polish Supreme™	380.00
BG 071 PS RH	Polish Supreme™	380.00

- 700mm x 1100mm, centre to centre
- 32mm rail fabricated from 304 stainless steel with 3.0mm wall thickness
- 78mm pre-formed domed Clam® Flange
- Wall clearance 55mm
- Stainless steel fixings screws supplied
- Meets the requirements of AS 1428.1:2021 Design for access and mobility
- Tested by QTL to 400kg (test report 203703 9236 - 06/02/2020)



Options available on request

- Shower kits - see pages 96-101

BARIATRIC COLLECTION

GRAB RAILS - ACCESSIBLE TOILET ASSIST



Engineered 32mm grab rails reinforced for bariatric applications. Fabricated from 304 stainless steel with 3.0mm wall thickness, fitted with our 78mm pre-formed domed Clam® Flange. Manufactured to comply with Section 14 of AS 1428.1:2021.

	Code	Finish	GST Exempt	Features
BARIATRIC 40° AMBULANT AND ACCESSIBLE GRAB RAILS 870MM x 700MM				
<p>NEW</p> <p>870</p> <p>700</p> <p>40°</p> <p>Drawn LH (Left Hand)</p>	BG 877 BS LH	Brushed Stainless	280.00	<ul style="list-style-type: none"> • 870mm x 700mm • 32mm rail fabricated from 304 stainless steel with 3.0mm wall thickness • 78mm pre-formed domed Clam® Flange • Wall clearance 55mm • Stainless steel fixings screws supplied • Meets the requirements of AS 1428.1:2021 Design for access and mobility <p>Options available on request</p> <ul style="list-style-type: none"> • Welded Toilet Paper Holder (Factory Fitted) - see page 92
	BG 877 BS RH	Brushed Stainless	280.00	
	BG 877 PS LH	Polish Supreme™	340.00	
	BG 877 PS RH	Polish Supreme™	340.00	
BARIATRIC 90° AMBULANT AND ACCESSIBLE GRAB RAILS 450MM x 450MM				
<p>NEW</p> <p>450</p> <p>450</p> <p>Drawn LH (Left Hand)</p>	BG 454 BS LH	Brushed Stainless	260.00	<ul style="list-style-type: none"> • 450mm x 450mm • 32mm rail fabricated from 304 stainless steel with 3.0mm wall thickness • 78mm pre-formed domed Clam® Flange • Wall clearance 55mm • Stainless steel fixings screws supplied • Meets the requirements of AS 1428.1:2021 Design for access and mobility <p>Options available on request</p> <ul style="list-style-type: none"> • Welded Toilet Paper Holder (Factory Fitted) - see page 92
	BG 454 BS RH	Brushed Stainless	260.00	
	BG 454 PS LH	Polish Supreme™	320.00	
	BG 454 PS RH	Polish Supreme™	320.00	
BARIATRIC 90° AMBULANT AND ACCESSIBLE GRAB RAILS 960MM x 600MM				
<p>NEW</p> <p>960</p> <p>600</p> <p>Drawn LH (Left Hand)</p>	BG 966 BS LH	Brushed Stainless	290.00	<ul style="list-style-type: none"> • 870mm x 700mm • 32mm rail fabricated from 304 stainless steel with 3.0mm wall thickness • 78mm pre-formed domed Clam® Flange • Wall clearance 55mm • Stainless steel fixings screws supplied • Meets the requirements of AS 1428.1:2021 Design for access and mobility <p>Options available on request</p> <ul style="list-style-type: none"> • Welded Toilet Paper Holder (Factory Fitted) - see page 92
	BG 966 BS RH	Brushed Stainless	290.00	
	BG 966 PS LH	Polish Supreme™	350.00	
	BG 966 PS RH	Polish Supreme™	350.00	

Bariatric healthcare showers are made from the highest quality materials and feature dual check facilities as per AS/NZ 3500. Reinforced for bariatric applications, Bariatric showers are fabricated from 304 stainless steel with 3.0mm wall thickness for durable strength and stability.



BARIATRIC SHOWER KIT 9



ABS Glide Slide Cradle

LOAD RATED TO 400KG

Code	Finish	GST Exempt	Features
------	--------	------------	----------

BG 01809 C	Chrome	362.00	<ul style="list-style-type: none"> • 900mm bariatric 32mm grab rail fabricated from 304 stainless steel with 3.0mm wall thickness • Hoscare® handpiece with Biomaster antimicrobial additive • ABS glide slide cradle • Flow Interchange® spigot • Licenced dual check/non-return as per WaterMark AS/NZS 2845.1 WMKA 02696 • 1500mm Silverflex® PVC shower hose • Meets the requirements of AS 1428.1:2021 Design for access and mobility • WaterMark AS/NZS 3662 WMKT 21147 • Available in 3 Star 9L/min and 4 Star 6.5L/min as per WELS licence number 0046 • Tested by QTL to 400kg (test report 203703 9236 - 06/02/2020)
BG 01809 C/6.5	Chrome	362.00	
BG 01809 CC	Commercial Chrome	332.00	
BG 01809 CC/6.5	Commercial Chrome	332.00	



Options available on request

- HR 015 C - Hose Restrictor Bracket

BARIATRIC SHOWER KIT 16



ABS Glide Slide Cradle

LOAD RATED TO 400KG

BG 01816 C LH	Chrome	562.00	<ul style="list-style-type: none"> • 700mm x 1100mm 32mm grab rail fabricated from 304 stainless steel with 3.0mm wall thickness • Hoscare® handpiece with Biomaster antimicrobial additive • ABS glide slide cradle • Flow Interchange® spigot • Licenced dual check/non-return as per WaterMark AS/NZS 2845.1 WMKA 02696 • 1500mm Silverflex® PVC shower hose • Meets the requirements of AS 1428.1:2021 Design for access and mobility • WaterMark AS/NZS 3662 WMKT 21147 • Available in 3 Star 9L/min and 4 Star 6.5L/min as per WELS licence number 0046 • Tested by QTL to 400kg (test report 203703 9236 - 06/02/2020)
BG 01816 C LH/6.5	Chrome	562.00	
BG 01816 C RH	Chrome	562.00	
BG 01816 C RH/6.5	Chrome	562.00	
BG 01816 CC LH	Commercial Chrome	492.00	
BG 01816 CC LH/6.5	Commercial Chrome	492.00	
BG 01816 CC RH	Commercial Chrome	492.00	
BG 01816 CC RH/6.5	Commercial Chrome	492.00	









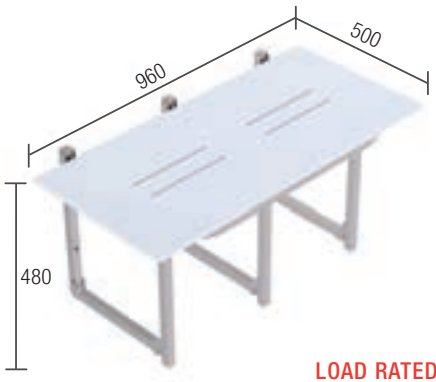

Options available on request

- HR 015 C - Hose Restrictor Bracket

BARIATRIC COLLECTION SHOWER SEAT AND TILTLOCK®

Con-Serv's Bariatric Shower Seat and Tiltlock® folding grab rails are designed with additional reinforcement for bariatric applications. Con-Serv Bariatric Shower Seat and Tiltlock® have been tested for a maximum load of 400kg.

	Code	Finish	GST Exempt	Features
BARIATRIC SHOWER SEAT FOR AREAS NOT STRICTLY DISABLED				
 <p>LOAD RATED TO 400KG</p>	SS 965 BS	Brushed Stainless	870.00	<ul style="list-style-type: none"> • Seat size: 960mm x 500mm • Additional centre support • Larger seat with self draining channels • Folding legs for added support • Stainless steel fixing screws supplied • Reinforced for bariatric applications, maximum load 400kg <p>Test Report 203780 9349 (29/07/2020)</p> 
BARIATRIC TILTLOCK® 850MM WITH FOLDING LEG				
 <p>LOAD RATED TO 400KG</p>	TL 850 BS LHBL	Brushed Stainless	710.00	<ul style="list-style-type: none"> • 850mm folding grab rail with folding leg • Reinforced for bariatric applications, maximum vertical load 400kg • Fabricated from 32mm 304 stainless steel • Locks in horizontal or vertical positions • Chrome plated brass push-button release, base housing, and concealed "T" mount bracket • Stainless steel fixings supplied • Tested by ANTL (test report 4699.11-12/12/2017) 
	TL 850 BS RHBL	Brushed Stainless	710.00	
Drawn RH (Right Hand)				
BARIATRIC FOLDING LEG TILTLOCK® 850MM GRAB RAIL WITH FOLDING LEG & NURSE CALL				
 <p>LOAD RATED TO 400KG</p>	TL 850 BS LHBN*	Brushed Stainless	795.00	<ul style="list-style-type: none"> • 850mm folding grab rail with folding leg • Fitted with 304 stainless steel nurse call mount box • Reinforced for bariatric applications, maximum vertical load 400kg • Fabricated from 32mm 304 stainless steel • Locks in horizontal or vertical positions • Chrome plated brass push-button release, base housing, and concealed "T" mount bracket • Stainless steel fixings supplied • Tested by ANTL (test report 4699.11-12/12/2017) 
	TL 850 BS RHBN*	Brushed Stainless	795.00	
Drawn RH (Right Hand)				
BARIATRIC TILTLOCK® 850MM GRAB RAIL WITH FOLDING LEG & TOILET PAPER HOLDER				
 <p>LOAD RATED TO 400KG</p>	TL 850 BS LHBS*	Brushed Stainless	760.00	<ul style="list-style-type: none"> • 850mm folding grab rail with folding leg • Fabricated from 32mm 304 stainless steel • Welded stainless steel toilet paper holder • Reinforced for bariatric applications, maximum vertical load 400kg • Locks in horizontal or vertical positions • Chrome plated brass push-button release, base housing, and concealed "T" mount bracket • Stainless steel fixings supplied • Tested by ANTL (test report 4699.11-12/12/2017) 
	TL 850 BS RHBS*	Brushed Stainless	760.00	
Drawn RH (Right Hand)				

Clam® Flange Collection



Code	Finish	GST Exempt	Features
------	--------	------------	----------

CLAM® FLANGE STRAIGHT GRAB RAILS

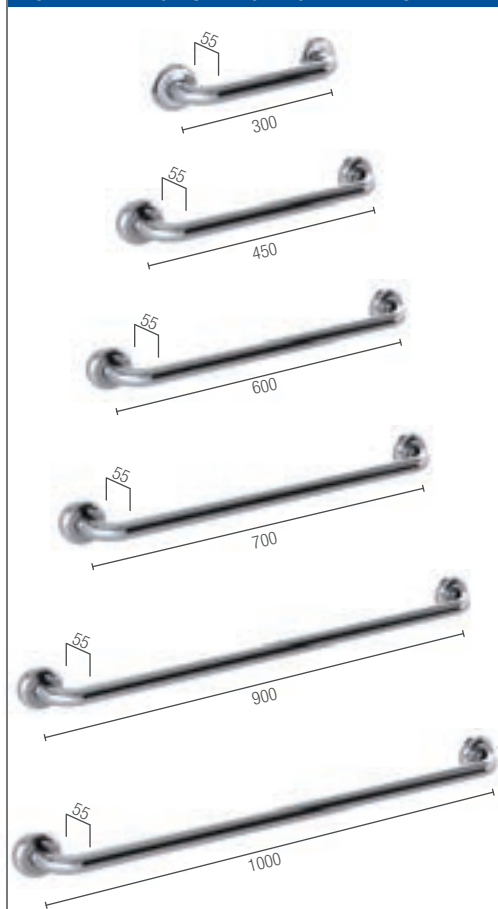

300MM		
CF 300 BS	Brushed Stainless	42.00
CF 300 PS	Polish Supreme™	52.00
450MM		
CF 450 BS	Brushed Stainless	46.00
CF 450 PS	Polish Supreme™	57.00
600MM		
CF 600 BS	Brushed Stainless	52.00
CF 600 PS	Polish Supreme™	65.00
700MM		
CF 700 BS	Brushed Stainless	56.00
CF 700 PS	Polish Supreme™	70.00
900MM		
CF 900 BS	Brushed Stainless	63.00
CF 900 PS	Polish Supreme™	75.00
1000MM		
CF 1000 BS	Brushed Stainless	68.00
CF 1000 PS	Polish Supreme™	79.00

- 300mm, 450mm, 600mm, 700mm, 900mm and 1000mm, centre to centre
- 78mm pre-formed domed Clam® Flange
- Clam plate is fully welded to 32mm rail for maximum strength
- Clam flange cover is a firm press fit to clam plate
- Fabricated from 304 stainless steel
- Stainless steel fixing screws supplied
- Meets the requirements of AS 1428.1:2021 Design for access and mobility



Options available on request

- Welded Toilet Paper Holder (Factory Fitted) - see page 92
- ABS Flexible Toilet Paper Holder - see page 92
- Shower kits - see pages 96-101

CLAM® FLANGE 40° AMBULANT AND ACCESSIBLE GRAB RAILS 450MM x 450MM



CF 045 BS	Brushed Stainless	69.00
CF 045 PS	Polish Supreme™	90.00

- 450mm x 450mm, centre to centre
- 78mm pre-formed domed Clam® Flange
- Clam plate is fully welded to 32mm rail for maximum strength
- Clam flange cover is a firm press fit to clam plate
- Fabricated from 304 stainless steel
- Stainless steel fixing screws supplied
- Meets the requirements of AS 1428.1:2021 Design for access and mobility



Options available on request

- Welded Toilet Paper Holder (Factory Fitted) - see page 92
- ABS Flexible Toilet Paper Holder - see page 92

CLAM® FLANGE 40° AMBULANT AND ACCESSIBLE GRAB RAILS 870MM X 700MM

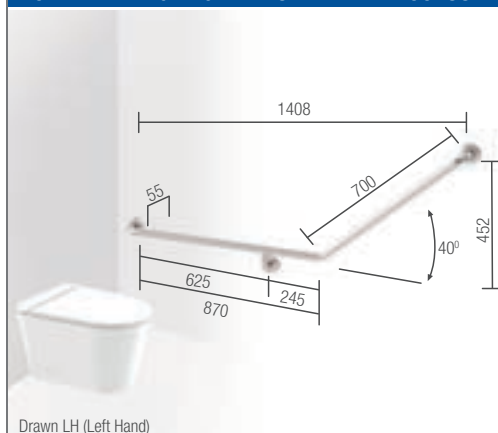

CF 877 BS LH	Brushed Stainless	125.00
CF 877 BS RH	Brushed Stainless	125.00
CF 877 PS LH	Polish Supreme™	155.00
CF 877 PS RH	Polish Supreme™	155.00

- 870mm x 700mm, centre to centre
- 78mm pre-formed domed Clam® Flange
- Clam plate is fully welded to 32mm rail for maximum strength
- Clam flange cover is a firm press fit to clam plate
- Fabricated from 304 stainless steel
- Stainless steel fixing screws supplied
- Meets the requirements of AS 1428.1:2021 Design for access and mobility







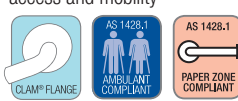

Options available on request

- Welded Toilet Paper Holder (Factory Fitted) - see page 92
- ABS Flexible Toilet Paper Holder - see page 92

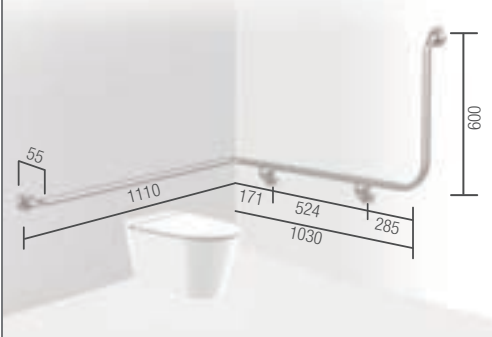
CLAM® FLANGE GRAB RAILS - ACCESSIBLE TOILET ASSIST

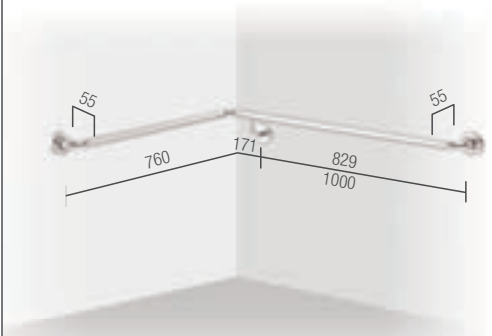
Con-Serv's Clam® Flange grab rails are fabricated from 32mm x 1.2mm grade 304, 18/8 stainless steel, and pre-formed 76mm, 5 screw wall mount plate with 360mm rear weld joint. Assembled with 78mm domed Clam® Flange cover with 5° radius to comply with Section 14 of AS 1428.1:2021.

	Code	Finish	GST Exempt	Features
CLAM® FLANGE 90° AMBULANT AND ACCESSIBLE GRAB RAILS 450MM x 450MM				
 <p>Reversible, Drawn LH (Left Hand)</p>	CF 454 BS	Brushed Stainless	69.00	<ul style="list-style-type: none"> • 450mm x 450mm, centre to centre • 78mm pre-formed domed Clam® Flange • Clam plate is fully welded to 32mm rail for maximum strength • Clam flange cover is a firm press fit to clam plate • Fabricated from 304 stainless steel • Stainless steel fixing screws supplied • Meets the requirements of AS 1428.1:2021 Design for access and mobility  <p>Options available on request</p> <ul style="list-style-type: none"> • Welded Toilet Paper Holder (Factory Fitted) - see page 92 • ABS Flexible Toilet Paper Holder - see page 92
	CF 454 PS	Polish Supreme™	90.00	
CLAM® FLANGE 90° AMBULANT AND ACCESSIBLE GRAB RAILS 960MM X 600MM				
 <p>Drawn LH (Left Hand)</p>	CF 966 BS LH	Brushed Stainless	120.00	<ul style="list-style-type: none"> • 960mm x 600mm, centre to centre • 78mm pre-formed domed Clam® Flange • Clam plate is fully welded to 32mm rail for maximum strength • Clam flange cover is a firm press fit to clam plate • Fabricated from 304 stainless steel • Stainless steel fixing screws supplied • Meets the requirements of AS 1428.1:2021 Design for access and mobility  <p>Options available on request</p> <ul style="list-style-type: none"> • Welded Toilet Paper Holder (Factory Fitted) - see page 92 • ABS Flexible Toilet Paper Holder - see page 92
	CF 966 BS RH	Brushed Stainless	120.00	
	CF 966 PS LH	Polish Supreme™	155.00	
	CF 966 PS RH	Polish Supreme™	155.00	
CLAM® FLANGE CORNER GRAB RAILS 1110MM X 1030MM X 600MM				
 <p>Drawn LH (Left Hand) Suits Backrest installation</p>	CF 116 BS LH	Brushed Stainless	235.00	<ul style="list-style-type: none"> • 1110mm x 1030mm x 600mm, centre to centre • 78mm pre-formed domed Clam® Flange • Clam plate is fully welded to 32mm rail for maximum strength • Clam flange cover is a firm press fit to clam plate • Fabricated from 304 stainless steel • Stainless steel fixing screws supplied • Meets the requirements of AS 1428.1:2021 Design for access and mobility  <p>Options available on request</p> <ul style="list-style-type: none"> • Welded Toilet Paper Holder (Factory Fitted) - see page 92 • ABS Flexible Toilet Paper Holder - see page 92
	CF 116 BS RH	Brushed Stainless	235.00	
	CF 116 PS LH	Polish Supreme™	280.00	
	CF 116 PS RH	Polish Supreme™	280.00	
CLAM® FLANGE CORNER GRAB RAILS 760MM X 1000MM				
 <p>Drawn LH (Left Hand)</p>	CF 761 BS LH	Brushed Stainless	150.00	<ul style="list-style-type: none"> • 760mm x 1000mm • 78mm pre-formed domed Clam® Flange • Clam plate is fully welded to 32mm rail for maximum strength • Clam flange cover is a firm press fit to clam plate • Fabricated from 304 stainless steel • Stainless steel fixing screws supplied • Meets the requirements of AS 1428.1:2021 Design for access and mobility  <p>Options available on request</p> <ul style="list-style-type: none"> • Welded Toilet Paper Holder (Factory Fitted) - see page 92 • ABS Flexible Toilet Paper Holder - see page 92
	CF 761 BS RH	Brushed Stainless	150.00	
	CF 761 PS LH	Polish Supreme™	190.00	
	CF 761 PS RH	Polish Supreme™	190.00	

CLAM® FLANGE GRAB RAILS - SHOWER RECESS

Con-Serv's Clam® Flange grab rails are fabricated from 32mm x 1.2mm grade 304, 18/8 stainless steel, and pre-formed 76mm, 5 screw wall mount plate with 360mm rear weld joint. Assembled with 78mm domed Clam® Flange cover with 5° radius to comply with Section 14 of AS 1428.1:2021.

	Code	Finish	GST Exempt	Features
CLAM® FLANGE SHOWER RECESS INVERTED "T" GRAB RAILS 700MM X 1100MM				
	CF 071 BS LH	Brushed Stainless	125.00	<ul style="list-style-type: none"> • 700mm x 1100mm inverted "T" grab rail, centre to centre • 78mm pre-formed domed Clam® Flange • Clam plate is fully welded to 32mm rail for maximum strength • Clam flange cover is a firm press fit to clam plate • Fabricated from 304 stainless steel • Stainless steel fixing screws supplied • Meets the requirements of AS 1428.1:2021 Design for access and mobility
	CF 071 BS RH	Brushed Stainless	125.00	
	CF 071 PS LH	Polish Supreme™	160.00	
	CF 071 PS RH	Polish Supreme™	160.00	
CLAM® FLANGE CORNER SHOWER RECESS GRAB RAIL 760MM X 1000MM X 1100MM				
	CF 711 BS LH	Brushed Stainless	260.00	<ul style="list-style-type: none"> • 760mm x 1000mm x 1100mm • 78mm pre-formed domed Clam® Flange • Clam plate is fully welded to 32mm rail for maximum strength • Clam flange cover is a firm press fit to clam plate • Fabricated from 304 stainless steel • Stainless steel fixing screws supplied • Meets the requirements of AS 1428.1:2021 Design for access and mobility
	CF 711 BS RH	Brushed Stainless	260.00	
	CF 711 PS LH	Polish Supreme™	310.00	
	CF 711 PS RH	Polish Supreme™	310.00	



Options available on request

- ABS Grab Rail Soap Dish Holder - see page 94
- Shower kits - see pages 96-101



Options available on request

- ABS Grab Rail Soap Dish Holder - see page 94
- Shower kits - see pages 96-101

CLAM® FLANGE SHOWER KITS

Clam® Flange healthcare showers are made from the highest quality materials and feature dual check facilities as per AS/NZ 3500. Designed for aged care, hospitals and public facilities, all Con-Serv grab rail showers comply with Section 14 of AS 1428.1:2021 and are WELS rated as per licence number 0046.

AS 1428.1:2021 Shower Head

An adjustable shower head holder shall be provided to support the shower head and shall allow the graspable portion of the shower head to be positioned at various angles and heights and also allow the graspable portion of the shower head to be located at heights between 1000mm and 1800mm above the plane of the finished floor and allow access and adjustment from a seated position.

The above clause only applies to accessible bathrooms in public buildings, factories, hotels, motels and designated bathrooms in hospitals, homes for the elderly and nursing homes.

	Code	Finish	GST Exempt	Features	
CLAM® FLANGE ACCESSIBLE KIT 3					
	WITH 1500MM SHOWER HOSE			<ul style="list-style-type: none"> • 1000mm grab rail • 78mm pre-formed domed Clam® Flange • Friction Slide handset cradle • Push-PullMe® shower height adjustment rod • Hoscare® handpiece with Biomaster antimicrobial additive • Chrome plated DR brass wall outlet elbow • Flow Interchange® spigot • Licenced dual check/non-return as per WaterMark AS/NZS 2845.1 WMKA 02696 • 57mm solid brass round flat flange • Silverflex® PVC shower hose • WaterMark AS/NZS 3662 WMKT 21147 • Available in 3 Star 9L/min and 4 Star 6.5L/min as per WELS licence number 0046 • Complies with section 12.5.6 (e) of AS 1428.1:2021: (e) allow access and adjustment from a seated position • Meets the requirements of AS 1428.1:2021 Design for access and mobility 	
	IC 01803 C	Chrome	361.00		
	IC 01803 C/6.5	Chrome	361.00		
	IC 01803 CC	Commercial Chrome	350.00		
	IC 01803 CC/6.5	Commercial Chrome	350.00		
	WITH 2000MM SHOWER HOSE				
	IC 01803 C2	Chrome	366.00		
	IC 01803 C2/6.5	Chrome	366.00		
	IC 01803 CC2	Commercial Chrome	355.00		
	IC 01803 CC2/6.5	Commercial Chrome	355.00		

CLAM® FLANGE ACCESSIBLE KIT 20				
	WITH 1500MM SHOWER HOSE			<ul style="list-style-type: none"> • 700mm x 1100mm grab rail • 78mm pre-formed domed Clam® Flange • Friction Slide handset cradle • Push-PullMe® shower height adjustment rod • Hoscare® handpiece with Biomaster antimicrobial additive care • Chrome plated DR brass wall outlet elbow • Flow Interchange® spigot • Licenced dual check/non-return as per WaterMark AS/NZS 2845.1 WMKA 02696 • 57mm solid brass round flat flange • Silverflex® PVC shower hose • WaterMark AS/NZS 3662 WMKT 21147 • Available in 3 Star 9L/min and 4 Star 6.5L/min as per WELS licence number 0046 • Complies with section 12.5.6 (e) of AS 1428.1:2021: (e) allow access and adjustment from a seated position • Meets the requirements of AS 1428.1:2021 Design for access and mobility
	IC 01820 C LH	Chrome	442.00	
	IC 01820 C LH/6.5	Chrome	442.00	
	IC 01820 C RH	Chrome	442.00	
	IC 01820 C RH/6.5	Chrome	442.00	
	IC 01820 CC LH	Commercial Chrome	407.00	
	IC 01820 CC LH/6.5	Commercial Chrome	407.00	
	IC 01820 CC RH	Commercial Chrome	407.00	
	IC 01820 CC RH/6.5	Commercial Chrome	407.00	
	WITH 2000MM SHOWER HOSE			
	IC 01820 C2 LH	Chrome	447.00	
	IC 01820 C2 LH/6.5	Chrome	447.00	
IC 01820 C2 RH	Chrome	447.00		
IC 01820 C2 RH/6.5	Chrome	447.00		
IC 01820 CC2 LH	Commercial Chrome	412.00		
IC 01820 CC2 LH/6.5	Commercial Chrome	412.00		
IC 01820 CC2 RH	Commercial Chrome	412.00		
IC 01820 CC2 RH/6.5	Commercial Chrome	412.00		

CLAM® FLANGE SHOWER KITS

Clam® Flange healthcare showers are made from the highest quality materials and feature dual check facilities as per AS/NZ 3500. Designed for aged care, hospitals and public facilities, all Con-Serv grab rail showers comply with Section 14 of AS 1428.1:2021 and are WELS rated as per licence number 0046.



Code Finish GST Exempt Features

CLAM® FLANGE SHOWER KIT 3

NEW



Friction Slide Cradle



WITH 1500MM SHOWER HOSE		
CF 01803 C	Chrome	325.00
CF 01803 C/6.5	Chrome	325.00
CF 01803 CC	Commercial Chrome	313.00
CF 01803 CC/6.5	Commercial Chrome	313.00
WITH 2000MM SHOWER HOSE		
CF 01803 C2	Chrome	330.00
CF 01803 C2/6.5	Chrome	330.00
CF 01803 CC2	Commercial Chrome	318.00
CF 01803 CC2/6.5	Commercial Chrome	318.00

- 900mm grab rail
- 78mm pre-formed domed Clam® Flange
- Friction Slide handset cradle
- Hoscare® handpiece with Biomaster antimicrobial additive
- Chrome plated DR brass wall outlet elbow
- Flow Interchange® spigot
- Licenced dual check/non-return as per WaterMark AS/NZS 2845.1 WMKA 02696
- 57mm solid brass round flat flange
- Silverflex® PVC shower hose
- WaterMark AS/NZS 3662 WMKT 21147
- Available in 3 Star 9L/min and 4 Star 6.5L/min as per WELS licence number 0046
- Meets the requirements of AS 1428.1:2021 Design for access and mobility



- Options available on request**
- ABS Grab Rail Soap Dish Holder - see page 94

CLAM® FLANGE SHOWER KIT 9

NEW



ABS Glide Slide Cradle



WITH 1500MM SHOWER HOSE		
CF 01809 C	Chrome	257.00
CF 01809 C/6.5	Chrome	257.00
CF 01809 CC	Commercial Chrome	245.00
CF 01809 CC/6.5	Commercial Chrome	245.00
WITH 2000MM SHOWER HOSE		
CF 01809 C2	Chrome	262.00
CF 01809 C2/6.5	Chrome	262.00
CF 01809 CC2	Commercial Chrome	250.00
CF 01809 CC2/6.5	Commercial Chrome	250.00





- 900mm grab rail
- 78mm pre-formed domed Clam® Flange
- ABS Glide Slide handset cradle
- Hoscare® handpiece with Biomaster antimicrobial additive
- Chrome plated DR brass wall outlet elbow
- Flow Interchange® spigot
- Licenced dual check/non-return as per WaterMark AS/NZS 2845.1 WMKA 02696
- 57mm solid brass round flat flange
- Silverflex® PVC shower hose
- WaterMark AS/NZS 3662 WMKT 21147
- Available in 3 Star 9L/min and 4 Star 6.5L/min as per WELS licence number 0046
- Meets the requirements of AS 1428.1:2021 Design for access and mobility



- Options available on request**
- ABS Grab Rail Soap Dish Holder - see page 94

CLAM® FLANGE SHOWER KITS

Clam® Flange healthcare showers are made from the highest quality materials and feature dual check facilities as per AS/NZ 3500. Designed for aged care, hospitals and public facilities, all Con-Serv grab rail showers comply with Section 14 of AS 1428.1:2021 and are WELS rated as per licence number 0046.

	Code	Finish	GST Exempt	Features
CLAM® FLANGE SHOWER KIT 20				
	CF 01820 C LH	Chrome	410.00	<ul style="list-style-type: none"> • 700mm x 1100mm grab rail • 78mm pre-formed domed Clam® Flange • Friction Slide handset cradle • Hoscare® handpiece with Biomaster antimicrobial additive • Chrome plated DR brass wall outlet elbow • Flow Interchange® spigot • Licenced dual check/non-return as per WaterMark AS/NZS 2845.1 WMKA 02696 • 57mm solid brass round flat flange • 1500mm Silverflex PVC shower hose • WaterMark AS/NZS 3662 WMKT 21147 • Available in 3 Star 9L/min and 4 Star 6.5L/min as per WELS licence number 0046 • Meets the requirements of AS 1428.1:2021 Design for access and mobility  <p>Options available on request</p> <ul style="list-style-type: none"> • ABS Grab Rail Soap Dish Holder - see page 94
	CF 01820 C LH/6.5	Chrome	410.00	
	CF 01820 C RH	Chrome	410.00	
	CF 01820 C RH/6.5	Chrome	410.00	
	CF 01820 CC LH	Commercial Chrome	375.00	
	CF 01820 CC LH/6.5	Commercial Chrome	375.00	
	CF 01820 CC RH	Commercial Chrome	375.00	
	CF 01820 CC RH/6.5	Commercial Chrome	375.00	
CLAM® FLANGE SHOWER KIT 16				
	CF 01816 C LH	Chrome	342.00	<ul style="list-style-type: none"> • 700mm x 1100mm grab rail • 78mm pre-formed domed Clam® Flange • ABS Glide Slide handset cradle • Hoscare® handpiece with Biomaster antimicrobial additive • Chrome plated DR brass wall outlet elbow • Flow Interchange® spigot • Licenced dual check/non-return as per WaterMark AS/NZS 2845.1 WMKA 02696 • 57mm solid brass round flat flange • 1500mm Silverflex PVC shower hose • WaterMark AS/NZS 3662 WMKT 21147 • Available in 3 Star 9L/min and 4 Star 6.5L/min as per WELS licence number 0046 • Meets the requirements of AS 1428.1:2021 Design for access and mobility  <p>Options available on request</p> <ul style="list-style-type: none"> • ABS Grab Rail Soap Dish Holder - see page 94
	CF 01816 C LH/6.5	Chrome	342.00	
	CF 01816 C RH	Chrome	342.00	
	CF 01816 C RH/6.5	Chrome	342.00	
	CF 01816 CC LH	Commercial Chrome	307.00	
	CF 01816 CC LH/6.5	Commercial Chrome	307.00	
	CF 01816 CC RH	Commercial Chrome	307.00	
	CF 01816 CC RH/6.5	Commercial Chrome	307.00	

Hygienic Seal® Collection



	Code	Finish	GST Exempt	Features
HYGIENIC SEAL® STRAIGHT GRAB RAILS 200MM				
	HS 200 AW	Antimicrobial White	85.00	<ul style="list-style-type: none"> • 200mm, centre to centre • 32mm grab rail • Fabricated from 304 stainless steel • Assembled with 50mm brass screw on flange covers with Biomaster Thermoplastic Elastomer (TPE) fitted seals • Stainless steel fixing screws supplied • Meets the requirements of AS 1428.1:2021 Design for access and mobility
	HS 200 BS	Brushed Stainless	59.00	
	HS 200 MB	Matte Black	85.00	
	HS 200 PS	Polish Supreme™	65.00	
HYGIENIC SEAL® STRAIGHT GRAB RAILS 300MM				
	HS 300 AW	Antimicrobial White	90.00	<ul style="list-style-type: none"> • 300mm, centre to centre • 32mm grab rail • Fabricated from 304 stainless steel • Assembled with 50mm brass screw on flange covers with Biomaster Thermoplastic Elastomer (TPE) fitted seals • Stainless steel fixing screws supplied • Meets the requirements of AS 1428.1:2021 Design for access and mobility
	HS 300 BS	Brushed Stainless	60.00	
	HS 300 MB	Matte Black	90.00	
	HS 300 PS	Polish Supreme™	66.00	
HYGIENIC SEAL® STRAIGHT GRAB RAILS 400MM				
	HS 400 AW	Antimicrobial White	95.00	<ul style="list-style-type: none"> • 400mm, centre to centre • 32mm grab rail • Fabricated from 304 stainless steel • Assembled with 50mm brass screw on flange covers with Biomaster Thermoplastic Elastomer (TPE) fitted seals • Stainless steel fixing screws supplied • Meets the requirements of AS 1428.1:2021 Design for access and mobility
	HS 400 BS	Brushed Stainless	63.00	
	HS 400 MB	Matte Black	95.00	
	HS 400 PS	Polish Supreme™	69.00	
HYGIENIC SEAL® STRAIGHT GRAB RAILS 450MM				
	HS 450 AW	Antimicrobial White	98.00	<ul style="list-style-type: none"> • 450mm, centre to centre • 32mm grab rail • Fabricated from 304 stainless steel • Assembled with 50mm brass screw on flange covers with Biomaster Thermoplastic Elastomer (TPE) fitted seals • Stainless steel fixing screws supplied • Meets the requirements of AS 1428.1:2021 Design for access and mobility
	HS 450 BS	Brushed Stainless	65.00	
	HS 450 MB	Matte Black	98.00	
	HS 450 PS	Polish Supreme™	72.00	
HYGIENIC SEAL® STRAIGHT GRAB RAILS 500MM				
	HS 500 AW	Antimicrobial White	100.00	<ul style="list-style-type: none"> • 500mm, centre to centre • 32mm grab rail • Fabricated from 304 stainless steel • Assembled with 50mm brass screw on flange covers with Biomaster Thermoplastic Elastomer (TPE) fitted seals • Stainless steel fixing screws supplied • Meets the requirements of AS 1428.1:2021 Design for access and mobility
	HS 500 BS	Brushed Stainless	67.00	
	HS 500 MB	Matte Black	100.00	
	HS 500 PS	Polish Supreme™	74.00	
HYGIENIC SEAL® STRAIGHT GRAB RAILS 600MM				
	HS 600 AW	Antimicrobial White	105.00	<ul style="list-style-type: none"> • 600mm, centre to centre • 32mm grab rail • Fabricated from 304 stainless steel • Assembled with 50mm brass screw on flange covers with Biomaster Thermoplastic Elastomer (TPE) fitted seals • Stainless steel fixing screws supplied • Meets the requirements of AS 1428.1:2021 Design for access and mobility
	HS 600 BS	Brushed Stainless	70.00	
	HS 600 MB	Matte Black	105.00	
	HS 600 PS	Polish Supreme™	77.00	
HYGIENIC SEAL® STRAIGHT GRAB RAILS 700MM				
	HS 700 AW	Antimicrobial White	110.00	<ul style="list-style-type: none"> • 700mm, centre to centre • 32mm grab rail • Fabricated from 304 stainless steel • Assembled with 50mm brass screw on flange covers with Biomaster Thermoplastic Elastomer (TPE) fitted seals • Stainless steel fixing screws supplied • Meets the requirements of AS 1428.1:2021 Design for access and mobility
	HS 700 BS	Brushed Stainless	72.00	
	HS 700 MB	Matte Black	110.00	
	HS 700 PS	Polish Supreme™	82.00	
HYGIENIC SEAL® STRAIGHT GRAB RAILS 750MM				
	HS 750 AW	Antimicrobial White	115.00	<ul style="list-style-type: none"> • 750mm, centre to centre • 32mm grab rail • Fabricated from 304 stainless steel • Assembled with 50mm brass screw on flange covers with Biomaster Thermoplastic Elastomer (TPE) fitted seals • Stainless steel fixing screws supplied • Meets the requirements of AS 1428.1:2021 Design for access and mobility
	HS 750 BS	Brushed Stainless	74.00	
	HS 750 MB	Matte Black	115.00	
	HS 750 PS	Polish Supreme™	84.00	

HYGIENIC SEAL® GRAB RAILS - STRAIGHT

Hygienic Seal® premium 32mm grab rails are fabricated from stainless steel with 50mm screw on flange covers featuring Biomaster Thermoplastic Elastomer (TPE) seals. Boasting our smallest flange, Hygienic Seal® grab rails are available in a range of finishes ideal for domestic and commercial environments.



Biomaster antimicrobial seals for added protection against bacteria

	Code	Finish	GST Exempt	Features
HYGIENIC SEAL® STRAIGHT GRAB RAILS 800MM				
	HS 800 AW	Antimicrobial White	125.00	<ul style="list-style-type: none"> • 800mm, centre to centre • 32mm grab rail • Fabricated from 304 stainless steel • Assembled with 50mm brass screw on flange covers with Biomaster Thermoplastic Elastomer (TPE) fitted seals • Stainless steel fixing screws supplied • Meets the requirements of AS 1428.1:2021 Design for access and mobility
	HS 800 BS	Brushed Stainless	77.00	
	HS 800 MB	Matte Black	125.00	
	HS 800 PS	Polish Supreme™	88.00	
HYGIENIC SEAL® STRAIGHT GRAB RAILS 900MM				
	HS 900 AW	Antimicrobial White	135.00	<ul style="list-style-type: none"> • 900mm, centre to centre • 32mm grab rail • Fabricated from 304 stainless steel • Assembled with 50mm brass screw on flange covers with Biomaster Thermoplastic Elastomer (TPE) fitted seals • Stainless steel fixing screws supplied • Meets the requirements of AS 1428.1:2021 Design for access and mobility
	HS 900 BS	Brushed Stainless	80.00	
	HS 900 MB	Matte Black	135.00	
	HS 900 PS	Polish Supreme™	95.00	
HYGIENIC SEAL® STRAIGHT GRAB RAILS 1000MM				
	HS 1000 AW	Antimicrobial White	145.00	<ul style="list-style-type: none"> • 1000mm, centre to centre • 32mm grab rail • Fabricated from 304 stainless steel • Assembled with 50mm brass screw on flange covers with Biomaster Thermoplastic Elastomer (TPE) fitted seals • Stainless steel fixing screws supplied • Meets the requirements of AS 1428.1:2021 Design for access and mobility
	HS 1000 BS	Brushed Stainless	87.00	
	HS 1000 MB	Matte Black	145.00	
	HS 1000 PS	Polish Supreme™	100.00	
HYGIENIC SEAL® STRAIGHT GRAB RAILS 1100MM				
	HS 1100 AW	Antimicrobial White	155.00	<ul style="list-style-type: none"> • 1100mm, centre to centre • 32mm grab rail • Fabricated from 304 stainless steel • Assembled with 50mm brass screw on flange covers with Biomaster Thermoplastic Elastomer (TPE) fitted seals • Stainless steel fixing screws supplied • Meets the requirements of AS 1428.1:2021 Design for access and mobility
	HS 1100 BS	Brushed Stainless	90.00	
	HS 1100 MB	Matte Black	155.00	
	HS 1100 PS	Polish Supreme™	110.00	
HYGIENIC SEAL® STRAIGHT GRAB RAILS 1200MM				
	HS 1200 AW	Antimicrobial White	165.00	<ul style="list-style-type: none"> • 1200mm, centre to centre • 32mm grab rail • Fabricated from 304 stainless steel • Assembled with 50mm brass screw on flange covers with Biomaster Thermoplastic Elastomer (TPE) fitted seals • Stainless steel fixing screws supplied • Meets the requirements of AS 1428.1:2021 Design for access and mobility
	HS 1200 BS	Brushed Stainless	95.00	
	HS 1200 MB	Matte Black	165.00	
	HS 1200 PS	Polish Supreme™	115.00	
HYGIENIC SEAL® STRAIGHT GRAB RAILS 300MM WITH TOILET PAPER HOLDER				
	HS 300 AW LHS	Antimicrobial White	135.00	<ul style="list-style-type: none"> • 300mm, centre to centre • 32mm grab rail with factory fitted toilet roll holder • Fabricated from 304 stainless steel • Assembled with 50mm brass screw on flange covers with Biomaster Thermoplastic Elastomer (TPE) fitted seals • Stainless steel fixing screws supplied • Meets the requirements of AS 1428.1:2021 Design for access and mobility
	HS 300 AW RHS	Antimicrobial White	135.00	
	HS 300 BS LHS	Brushed Stainless	100.00	
	HS 300 BS RHS	Brushed Stainless	100.00	
	HS 300 MB LHS	Matte Black	135.00	
	HS 300 MB RHS	Matte Black	135.00	
	HS 300 PS LHS	Polish Supreme™	110.00	
	HS 300 PS RHS	Polish Supreme™	110.00	
Drawn RH (Right Hand)				
HYGIENIC SEAL® STRAIGHT GRAB RAILS 450MM WITH TOILET PAPER HOLDER				
	HS 450 AW LHS	Antimicrobial White	150.00	<ul style="list-style-type: none"> • 450mm, centre to centre • 32mm grab rail with factory fitted toilet roll holder • Fabricated from 304 stainless steel • Assembled with 50mm brass screw on flange covers with Biomaster Thermoplastic Elastomer (TPE) fitted seals • Stainless steel fixing screws supplied • Meets the requirements of AS 1428.1:2021 Design for access and mobility
	HS 450 AW RHS	Antimicrobial White	150.00	
	HS 450 BS LHS	Brushed Stainless	110.00	
	HS 450 BS RHS	Brushed Stainless	110.00	
	HS 450 MB LHS	Matte Black	150.00	
	HS 450 MB RHS	Matte Black	150.00	
	HS 450 PS LHS	Polish Supreme™	125.00	
	HS 450 PS RHS	Polish Supreme™	125.00	
Drawn LH (Left Hand)				

HYGIENIC SEAL® GRAB RAILS - ACCESSIBLE TOILET ASSIST

Hygienic Seal® premium 32mm grab rails are fabricated from stainless steel with 50mm screw on flange covers featuring Biomaster Thermoplastic Elastomer (TPE) seals. Boasting our smallest flange, Hygienic Seal® grab rails are available in a range of finishes ideal for domestic and commercial environments.



Biomaster antimicrobial seals for added protection against bacteria

Code Finish GST Exempt Features

HYGIENIC SEAL® 40° AMBULANT AND ACCESSIBLE GRAB RAILS 450MM X 450MM				
<p>Drawn LH (Left Hand)</p>	HS 045 AW LH	Antimicrobial White	180.00	<ul style="list-style-type: none"> • 450mm x 450mm • 32mm grab rail fabricated from 304 stainless steel • Assembled with 50mm brass screw on flange covers with Biomaster Thermoplastic Elastomer (TPE) fitted seals • Stainless steel fixing screws supplied • Meets the requirements of AS 1428.1:2021 Design for access and mobility <p>Options available on request</p> <ul style="list-style-type: none"> • Welded Toilet Paper Holder (Factory Fitted) - see page 92 • ABS Flexible Toilet Paper Holder - see page 92
	HS 045 AW RH	Antimicrobial White	180.00	
	HS 045 BS LH	Brushed Stainless	126.00	
	HS 045 BS RH	Brushed Stainless	126.00	
	HS 045 MB LH	Matte Black	180.00	
	HS 045 MB RH	Matte Black	180.00	
	HS 045 PS LH	Polish Supreme™	140.00	
	HS 045 PS RH	Polish Supreme™	140.00	

HYGIENIC SEAL® 40° AMBULANT AND ACCESSIBLE GRAB RAILS 870MM X 700MM				
<p>Drawn LH (Left Hand)</p>	HS 877 AW LH	Antimicrobial White	270.00	<ul style="list-style-type: none"> • 870mm x 700mm • 32mm grab rail fabricated from 304 stainless steel • Assembled with 50mm brass screw on flange covers with Biomaster Thermoplastic Elastomer (TPE) fitted seals • Stainless steel fixing screws supplied • Meets the requirements of AS 1428.1:2021 Design for access and mobility <p>Options available on request</p> <ul style="list-style-type: none"> • Welded Toilet Paper Holder (Factory Fitted) - see page 92 • ABS Flexible Toilet Paper Holder - see page 92
	HS 877 AW RH	Antimicrobial White	270.00	
	HS 877 BS LH	Brushed Stainless	175.00	
	HS 877 BS RH	Brushed Stainless	175.00	
	HS 877 MB LH	Matte Black	270.00	
	HS 877 MB RH	Matte Black	270.00	
	HS 877 PS LH	Polish Supreme™	190.00	
	HS 877 PS RH	Polish Supreme™	190.00	

HYGIENIC SEAL® 90° AMBULANT AND ACCESSIBLE GRAB RAILS 450MM X 450MM				
<p>Drawn LH (Left Hand)</p>	HS 454 AW LH	Antimicrobial White	160.00	<ul style="list-style-type: none"> • 450mm x 450mm • 32mm grab rail fabricated from 304 stainless steel • Assembled with 50mm brass screw on flange covers with Biomaster Thermoplastic Elastomer (TPE) fitted seals • Stainless steel fixing screws supplied • Meets the requirements of AS 1428.1:2021 Design for access and mobility <p>Options available on request</p> <ul style="list-style-type: none"> • Welded Toilet Paper Holder (Factory Fitted) - see page 92 • ABS Flexible Toilet Paper Holder - see page 92
	HS 454 AW RH	Antimicrobial White	160.00	
	HS 454 BS LH	Brushed Stainless	122.00	
	HS 454 BS RH	Brushed Stainless	122.00	
	HS 454 MB LH	Matte Black	160.00	
	HS 454 MB RH	Matte Black	160.00	
	HS 454 PS LH	Polish Supreme™	135.00	
	HS 454 PS RH	Polish Supreme™	135.00	

HYGIENIC SEAL® 90° AMBULANT AND ACCESSIBLE GRAB RAILS 750MM X 750MM					
<p>Reversible Left or Right Hand installation</p> <p>Drawn LH (Left Hand)</p>	HS 775 BS	Brushed Stainless	150.00	<ul style="list-style-type: none"> • 750mm x 750mm, reversible installation • 32mm grab rail fabricated from 304 stainless steel • Assembled with 50mm brass screw on flange covers with Biomaster Thermoplastic Elastomer (TPE) fitted seals • Stainless steel fixing screws supplied • Complies with New Zealand standards 4121:2001 <p>Options available on request</p> <ul style="list-style-type: none"> • Welded Toilet Paper Holder (Factory Fitted) - see page 92 • ABS Flexible Toilet Paper Holder - see page 92 	

HYGIENIC SEAL® 90° AMBULANT AND ACCESSIBLE GRAB RAILS 960MM X 600MM				
<p>Drawn LH (Left Hand)</p>	HS 966 AW LH	Antimicrobial White	260.00	<ul style="list-style-type: none"> • 960mm x 600mm • 32mm grab rail fabricated from 304 stainless steel • Assembled with 50mm brass screw on flange covers with Biomaster Thermoplastic Elastomer (TPE) fitted seals • Stainless steel fixing screws supplied • Meets the requirements of AS 1428.1:2021 Design for access and mobility <p>Options available on request</p> <ul style="list-style-type: none"> • Welded Toilet Paper Holder (Factory Fitted) - see page 92 • ABS Flexible Toilet Paper Holder - see page 92
	HS 966 AW RH	Antimicrobial White	260.00	
	HS 966 BS LH	Brushed Stainless	175.00	
	HS 966 BS RH	Brushed Stainless	175.00	
	HS 966 MB LH	Matte Black	260.00	
	HS 966 MB RH	Matte Black	260.00	
	HS 966 PS LH	Polish Supreme™	195.00	
	HS 966 PS RH	Polish Supreme™	195.00	

HYGIENIC SEAL® GRAB RAILS - ACCESSIBLE TOILET ASSIST & CORNER



Biomaster antimicrobial seals for added protection against bacteria

Hygienic Seal® premium 32mm grab rails are fabricated from stainless steel with 50mm screw on flange covers featuring Biomaster Thermoplastic Elastomer (TPE) seals. Boasting our smallest flange, Hygienic Seal® grab rails are available in a range of finishes ideal for domestic and commercial environments.

	Code	Finish	GST Exempt	Features
HYGIENIC SEAL® 90° AMBULANT AND ACCESSIBLE GRAB RAILS 450MM X 450MM WITH TOILET PAPER HOLDER				
<p>Drawn LH (Left Hand)</p>	HS 454 AW LHS	Antimicrobial White	220.00	<ul style="list-style-type: none"> • 450mm x 450mm • 32mm grab rail with factory fitted toilet roll holder • Fabricated from 304 stainless steel • Assembled with 50mm brass screw on flange covers with Biomaster Thermoplastic Elastomer (TPE) fitted seals • Stainless steel fixing screws supplied • Meets the requirements of AS 1428.1:2021 Design for access and mobility
	HS 454 AW RHS	Antimicrobial White	220.00	
	HS 454 BS LHS	Brushed Stainless	155.00	
	HS 454 BS RHS	Brushed Stainless	155.00	
	HS 454 MB LHS	Matte Black	220.00	
	HS 454 MB RHS	Matte Black	220.00	
	HS 454 PS LHS	Polish Supreme™	180.00	
	HS 454 PS RHS	Polish Supreme™	180.00	
HYGIENIC SEAL® 90° AMBULANT AND ACCESSIBLE GRAB RAILS 960MM X 600MM WITH TOILET PAPER HOLDER				
<p>Drawn LH (Left Hand)</p>	HS 966 AW LHS	Antimicrobial White	280.00	<ul style="list-style-type: none"> • 960mm x 600mm • 32mm grab rail fabricated from 304 stainless steel • Assembled with 50mm brass screw on flange covers with Biomaster Thermoplastic Elastomer (TPE) fitted seals • Stainless steel fixing screws supplied • Meets the requirements of AS 1428.1:2021 Design for access and mobility
	HS 966 AW RHS	Antimicrobial White	280.00	
	HS 966 BS LHS	Brushed Stainless	210.00	
	HS 966 BS RHS	Brushed Stainless	210.00	
	HS 966 MB LHS	Matte Black	280.00	
	HS 966 MB RHS	Matte Black	280.00	
	HS 966 PS LHS	Polish Supreme™	240.00	
	HS 966 PS RHS	Polish Supreme™	240.00	
HYGIENIC SEAL® CORNER GRAB RAILS 1110MM X 1030MM X 600MM				
<p>Drawn LH (Left Hand)</p> <p>Suits Backrest installation</p>	HS 116 AW LH	Antimicrobial White	370.00	<ul style="list-style-type: none"> • 1110mm x 1030mm x 600mm • 32mm grab rail fabricated from 304 stainless steel • Assembled with 50mm brass screw on flange covers with Biomaster Thermoplastic Elastomer (TPE) fitted seals • Stainless steel fixing screws supplied • Meets the requirements of AS 1428.1:2021 Design for access and mobility <p>Options available on request</p> <ul style="list-style-type: none"> • Welded Toilet Paper Holder (Factory Fitted) - see page 92 • ABS Flexible Toilet Paper Holder - see page 92
	HS 116 AW RH	Antimicrobial White	370.00	
	HS 116 BS LH	Brushed Stainless	265.00	
	HS 116 BS RH	Brushed Stainless	265.00	
	HS 116 MB LH	Matte Black	370.00	
	HS 116 MB RH	Matte Black	370.00	
	HS 116 PS LH	Polish Supreme™	295.00	
	HS 116 PS RH	Polish Supreme™	295.00	
	HYGIENIC SEAL® CORNER GRAB RAILS 800MM X 800MM			
<p>Drawn LH (Left Hand)</p> <p>Made to order. NON-RETURNABLE</p>	HS 880 AW LH	Antimicrobial White	250.00	<ul style="list-style-type: none"> • 800mm x 800mm • 32mm grab rail fabricated from 304 stainless steel • Assembled with 50mm brass screw on flange covers with Biomaster Thermoplastic Elastomer (TPE) fitted seals • Stainless steel fixing screws supplied • Meets the requirements of AS 1428.1:2021 Design for access and mobility <p>Options available on request</p> <ul style="list-style-type: none"> • Welded Toilet Paper Holder (Factory Fitted) - see page 92 • ABS Flexible Toilet Paper Holder - see page 92
	HS 880 AW RH	Antimicrobial White	250.00	
	HS 880 BS LH	Brushed Stainless	175.00	
	HS 880 BS RH	Brushed Stainless	175.00	
	HS 880 MB LH	Matte Black	250.00	
	HS 880 MB RH	Matte Black	250.00	
	HS 880 PS LH	Polish Supreme™	190.00	
	HS 880 PS RH	Polish Supreme™	190.00	
HYGIENIC SEAL® CORNER GRAB RAILS 760MM X 1000MM				
<p>Drawn LH (Left Hand)</p>	HS 761 AW LH	Antimicrobial White	260.00	<ul style="list-style-type: none"> • 760mm x 1000mm • 32mm grab rail fabricated from 304 stainless steel • Assembled with 50mm brass screw on flange covers with Biomaster Thermoplastic Elastomer (TPE) fitted seals • Stainless steel fixing screws supplied • Meets the requirements of AS 1428.1:2021 Design for access and mobility <p>Options available on request</p> <ul style="list-style-type: none"> • Welded Toilet Paper Holder (Factory Fitted) - see page 92 • ABS Flexible Toilet Paper Holder - see page 92
	HS 761 AW RH	Antimicrobial White	260.00	
	HS 761 BS LH	Brushed Stainless	180.00	
	HS 761 BS RH	Brushed Stainless	180.00	
	HS 761 MB LH	Matte Black	260.00	
	HS 761 MB RH	Matte Black	260.00	
	HS 761 PS LH	Polish Supreme™	200.00	
	HS 761 PS RH	Polish Supreme™	200.00	

HYGIENIC SEAL® GRAB RAILS - SHOWER RECESS

Hygienic Seal® premium 32mm grab rails are fabricated from stainless steel with 50mm screw on flange covers featuring Biomaster Thermoplastic Elastomer (TPE) seals. Boasting our smallest flange, Hygienic Seal® grab rails are available in a range of finishes ideal for domestic and commercial environments.



Biomaster antimicrobial seals for added protection against bacteria

Code Finish GST Exempt Features

HYGIENIC SEAL® SHOWER RECESS INVERTED "T" GRAB RAILS 700MM X 1100MM

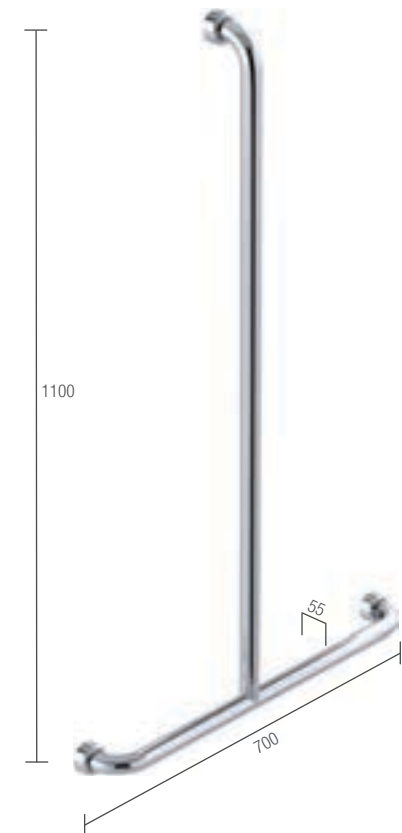

Drawn MF (Middle Fixed)

Only left and right hand positions meet the requirements of AS 1428.1:2021

HS 071 AW LH	Antimicrobial White	250.00
HS 071 AW MF	Antimicrobial White	250.00
HS 071 AW RH	Antimicrobial White	250.00
HS 071 BS LH	Brushed Stainless	165.00
HS 071 BS MF	Brushed Stainless	165.00
HS 071 BS RH	Brushed Stainless	165.00
HS 071 MB LH	Matte Black	250.00
HS 071 MBMF	Matte Black	250.00
HS 071 MB RH	Matte Black	250.00
HS 071 PS LH	Polish Supreme™	195.00
HS 071 PS MF	Polish Supreme™	195.00
HS 071 PS RH	Polish Supreme™	195.00

- 700mm x 1100mm inverted "T" grab rail
- 32mm grab rail fabricated from 304 stainless steel
- Assembled with 50mm brass screw on flange covers with Biomaster Thermoplastic Elastomer (TPE) fitted seals
- Stainless steel fixing screws supplied
- Available in Left Hand, Middle Fixed or Right Hand orientations
- Left and right hand models meet the requirements of AS 1428.1:2021 Design for access and mobility



Options available on request

- ABS Grab Rail Soap Dish Holder - see page 94
- Shower kits - see pages 96-101

HYGIENIC SEAL® CORNER SHOWER RECESS GRAB RAILS 760MM X 1000MM X 1100MM

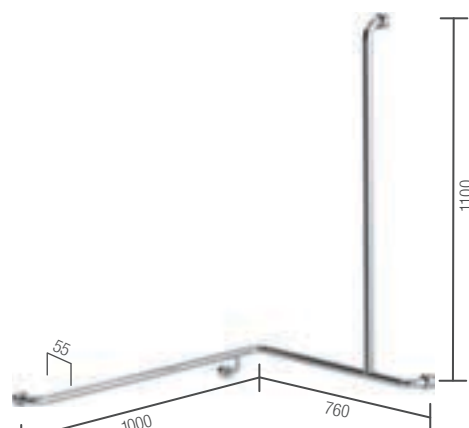

Drawn RH (Right Hand)

HS 711 AW LH	Antimicrobial White	400.00
HS 711 AW RH	Antimicrobial White	400.00
HS 711 BS LH	Brushed Stainless	260.00
HS 711 BS RH	Brushed Stainless	260.00
HS 711 MB LH	Matte Black	400.00
HS 711 MB RH	Matte Black	400.00
HS 711 PS LH	Polish Supreme™	340.00
HS 711 PS RH	Polish Supreme™	340.00

- 760mm x 1000mm x 1100mm grab rail
- 32mm grab rail fabricated from 304 stainless steel
- Assembled with 50mm brass screw on flange covers with Biomaster Thermoplastic Elastomer (TPE) fitted seals
- Stainless steel fixing screws supplied
- Meets the requirements of AS 1428.1:2021 Design for access and mobility



Options available on request

- ABS Grab Rail Soap Dish Holder - see page 94
- Shower kits - see pages 96-101



Drawn LH (Left Hand)

HYGIENIC SEAL® GRAB RAILS - TOWEL GRAB RAILS

Hygienic Seal® premium 32mm grab rails are fabricated from stainless steel with 50mm screw on flange covers featuring Biomaster Thermoplastic Elastomer (TPE) seals. Boasting our smallest flange, Hygienic Seal® grab rails are available in a range of finishes ideal for domestic and commercial environments.



Biomaster antimicrobial seals for added protection against bacteria

	Code	Finish	GST Exempt	Features
HYGIENIC SEAL® TOWEL GRAB RAILS 600MM "D" SHAPE				
	HT 600 AW D	Antimicrobial White	170.00	<ul style="list-style-type: none"> • 600mm "D" shape, centre to centre • 32mm grab rail fabricated from 304 stainless steel • Assembled with 50mm brass screw on flange covers with Biomaster Thermoplastic Elastomer (TPE) fitted seals • Stainless steel fixing screws supplied
	HT 600 BS D	Brushed Stainless	108.00	
	HT 600 MB D	Matt Black	170.00	
	HT 600 PS D	Polish Supreme™	120.00	
HYGIENIC SEAL® TOWEL GRAB RAILS 800MM "D" SHAPE				
	HT 800 AW D	Antimicrobial White	180.00	<ul style="list-style-type: none"> • 800mm "D" shape, centre to centre • 32mm grab rail fabricated from 304 stainless steel • Assembled with 50mm brass screw on flange covers with Biomaster Thermoplastic Elastomer (TPE) fitted seals • Stainless steel fixing screws supplied
	HT 800 BS D	Brushed Stainless	120.00	
	HT 800 MB D	Matt Black	180.00	
	HT 800 PS D	Polish Supreme™	148.00	
HYGIENIC SEAL® TOWEL GRAB RAILS 600MM "U" SHAPE				
	HT 600 AW U	Antimicrobial White	180.00	<ul style="list-style-type: none"> • 600mm "U" shape, centre to centre • 32mm grab rail fabricated from 304 stainless steel • Assembled with 50mm brass screw on flange covers with Biomaster Thermoplastic Elastomer (TPE) fitted seals • Stainless steel fixing screws supplied • Meets the requirements of AS 1428.1:2021 Design for access and mobility
	HT 600 BS U	Brushed Stainless	120.00	
	HT 600 MB U	Matt Black	180.00	
	HT 600 PS U	Polish Supreme™	130.00	
HYGIENIC SEAL® TOWEL GRAB RAILS 800MM "U" SHAPE				
	HT 800 AW U	Antimicrobial White	190.00	<ul style="list-style-type: none"> • 800mm "U" shape, centre to centre • 32mm grab rail fabricated from 304 stainless steel • Assembled with 50mm brass screw on flange covers with Biomaster Thermoplastic Elastomer (TPE) fitted seals • Stainless steel fixing screws supplied • Meets the requirements of AS 1428.1:2021 Design for access and mobility
	HT 800 BS U	Brushed Stainless	130.00	
	HT 800 MB U	Matt Black	190.00	
	HT 800 PS U	Polish Supreme™	150.00	

HYGIENIC SEAL® - GLIDE SLIDE 900MM

- 900mm grab rail
- Hygienic Seal® flange with antimicrobial seals
- Meets requirements of AS 1428.1:2021
- DR brass wall outlet elbow
- ABS Glide Slide Cradle
- ABS handpiece with rub-clean diffuser
- PVC 1500mm Silverflex™ hose
- Licenced dual check/non-return valve
- Brass 57mm wall flange
- Stainless steel fixings supplied



ABS Glide Slide Cradle

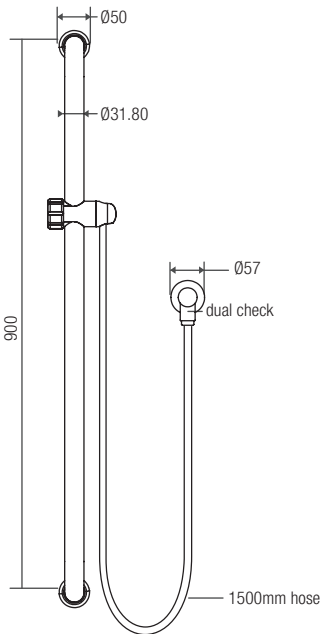

Model	Code	Finish	GST Exempt	Features
STREAMJET™				
	GS 900J C	Chrome	307.00	<ul style="list-style-type: none"> • ABS 100mm single function shower • Concentric full pattern spray • Rub-clean spray diffuser • WaterMark AS 3662 WMKT 21147 • Available in 3 Star 9L/min and 4 Star 6.5L/min as per WELS licence number 0046
	GS 900J C/6.5	Chrome	307.00	
	GS 900J WTC	White/Chrome	338.00	
	GS 900J WTC/6.5	White/Chrome	338.00	
STREAMJET™ TURBO PULSATOR				
	GS 900T C	Chrome	337.00	<ul style="list-style-type: none"> • ABS 100mm multi-function shower • Soft, pulsating and bubble spray functions • Rub-clean spray diffuser • WaterMark AS 3662 WMKT 21147 • Available in 3 Star 9L/min as per WELS licence number 0046
STREAMJET™ XL				
	GS 900X C	Chrome	332.00	<ul style="list-style-type: none"> • ABS 130mm single function shower • Concentric full pattern spray • Rub-clean spray diffuser • WaterMark AS 3662 WMKT 21147 • Available in 3 Star 9L/min as per WELS licence number 0046
STREAMJET™ XL TURBO PULSATOR				
	GS 900S C	Chrome	362.00	<ul style="list-style-type: none"> • ABS 130mm multi-function shower • Soft, pulsating and bubble spray functions • Rub-clean spray diffuser • WaterMark AS 3662 WMKT 21147 • Available in 3 Star 9L/min as per WELS licence number 0046
PRINCESS				
	GS 900P C	Chrome	292.00	<ul style="list-style-type: none"> • ABS 83mm arched single function shower • Full pattern spray • Rub-clean spray diffuser • WaterMark AS 3662 WMKT 21147 • Available in 3 Star 9L/min as per WELS licence number 0046
BREEZE				
	GS 900Z C	Chrome	308.00	<ul style="list-style-type: none"> • ABS 104mm arched multi-function shower • Soft, pulsating and bubble spray functions • Rub-clean spray diffuser • Available in 3 Star 9L/min as per WELS licence number 0046



Model shown: GS 900X C

HYGIENIC SEAL® - GLIDE SLIDE 700MM x 1100MM

- 700mm x 1100mm grab rail
- Hygienic Seal® flange with antimicrobial seals
- Licenced dual check/non-return valve
- DR brass wall outlet elbow
- ABS Glide Slide Cradle
- ABS handpiece with rub-clean diffuser
- PVC 1500mm Silverflex™ hose
- Brass 57mm wall flange
- Stainless steel fixings supplied



ABS Glide Slide Cradle

Drawn MF (Middle Fix)

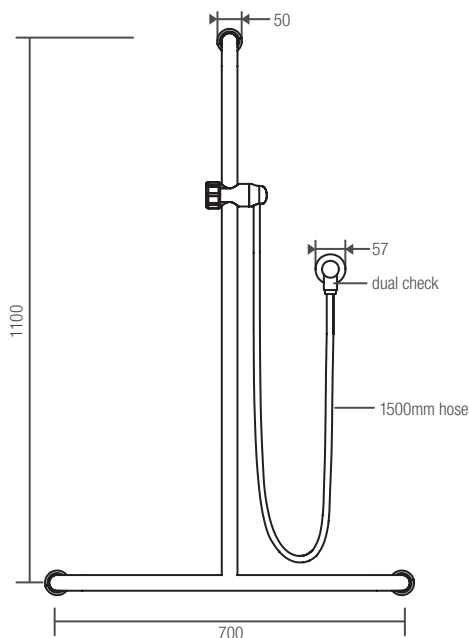

Model shown: GS 071T C MF



Model	Code	Finish	GST Exempt	Features
STREAMJET™				
	GS 071J C LH	Chrome	407.00	<ul style="list-style-type: none"> • ABS 100mm single function shower • Concentric full pattern spray • Rub-clean spray diffuser • WaterMark AS 3662 WMKT 21147 • Available in 3 Star 9L/min and 4 Star 6.5L/min as per WELS licence number 0046
	GS 071J C MF	Chrome	407.00	
	GS 071J C RH	Chrome	407.00	
	GS 071J C LH/6.5	Chrome	407.00	
	GS 071J C MF/6.5	Chrome	407.00	
	GS 071J C RH/6.5	Chrome	407.00	
	GS 071J WTC LH	White/Chrome	453.00	
	GS 071J WTC MF	White/Chrome	453.00	
	GS 071J WTC RH	White/Chrome	453.00	
	GS 071J WTC LH/6.5	White/Chrome	453.00	
	GS 071J WTC MF/6.5	White/Chrome	453.00	
GS 071J WTC RH/6.5	White/Chrome	453.00		
STREAMJET™ TURBO PULSATOR				
	GS 071T C LH	Chrome	437.00	<ul style="list-style-type: none"> • ABS 100mm multi-function shower • Soft, pulsating and bubble spray • Rub-clean spray diffuser • WaterMark AS 3662 WMKT 21147 • Available in 3 Star 9L/min as per WELS licence number 0046
	GS 071T C MF	Chrome	437.00	
	GS 071T C RH	Chrome	437.00	
STREAMJET™ XL				
	GS 071X C LH	Chrome	432.00	<ul style="list-style-type: none"> • ABS 130mm single function shower • Concentric full pattern spray • Rub-clean spray diffuser • WaterMark AS 3662 WMKT 21147 • Available in 3 Star 9L/min as per WELS licence number 0046
	GS 071X C MF	Chrome	432.00	
	GS 071X C RH	Chrome	432.00	
STREAMJET™ XL TURBO PULSATOR				
	GS 071S C LH	Chrome	462.00	<ul style="list-style-type: none"> • ABS 130mm multi-function shower • Soft, pulsating and bubble spray • Rub-clean spray diffuser • WaterMark AS 3662 WMKT 21147 • Available in 3 Star 9L/min as per WELS licence number 0046
	GS 071S C MF	Chrome	462.00	
	GS 071S C RH	Chrome	462.00	
PRINCESS				
	GS 071P C LH	Chrome	392.00	<ul style="list-style-type: none"> • ABS 83mm arched single function • Full pattern spray • Rub-clean spray diffuser • WaterMark AS 3662 WMKT 21147 • Available in 3 Star 9L/min as per WELS licence number 0046
	GS 071P C MF	Chrome	392.00	
	GS 071P C RH	Chrome	392.00	
BREEZE				
	GS 071Z C LH	Chrome	408.00	<ul style="list-style-type: none"> • ABS 104mm arched multi-function shower • Soft, pulsating and bubble spray • Rub-clean spray diffuser • Available in 3 Star 9L/min as per WELS licence number 0046
	GS 071Z C MF	Chrome	408.00	
	GS 071Z C RH	Chrome	408.00	



HYGIENIC SEAL® - FRICTION SLIDE 900MM



- 900mm grab rail
- Hygienic Seal® flange with antimicrobial seals
- Meets requirements of AS 1428.1:2021
- DR brass wall outlet elbow
- Brass Friction Slide Cradle
- ABS handpiece with rub-clean diffuser
- PVC 1500mm Silverflex™ hose
- Licenced dual check/non-return valve
- Brass 57mm wall flange
- Stainless steel fixings supplied







Model Code Finish GST Exempt Features



STREAMJET™				
	HF 900J BN	Brushed Nickel	487.00	<ul style="list-style-type: none"> • ABS 100mm single function shower • Concentric full pattern spray • Rub-clean spray diffuser • WaterMark AS 3662 WMKT 21147 • Available in 3 Star 9L/min and 4 Star 6.5L/min as per WELS licence number 0046 
	HF 900J BN/6.5	Brushed Nickel	487.00	
	HF 900J C	Chrome	375.00	
	HF 900J C/6.5	Chrome	375.00	
	HF 900J MB	Matte Black	502.00	
	HF 900J MB/6.5	Matte Black	502.00	

STREAMJET™ TURBO PULSATOR					
	HF 900T C	Chrome	405.00	<ul style="list-style-type: none"> • ABS 100mm multi-function shower • Soft, pulsating and bubble spray functions • Rub-clean spray diffuser • WaterMark AS 3662 WMKT 21147 • Available in 3 Star 9L/min as per WELS licence number 0046 	

STREAMJET™ XL				
	HF 900X BN	Brushed Nickel	522.00	<ul style="list-style-type: none"> • ABS 130mm single function shower • Concentric full pattern spray • Rub-clean spray diffuser • WaterMark AS 3662 WMKT 21147 • Available in 3 Star 9L/min as per WELS licence number 0046 
	HF 900X C	Chrome	400.00	
	HF 900X MB	Matte Black	537.00	

STREAMJET™ XL TURBO PULSATOR					
	HF 900S C	Chrome	430.00	<ul style="list-style-type: none"> • ABS 130mm multi-function shower • Soft, pulsating and bubble spray functions • Rub-clean spray diffuser • WaterMark AS 3662 WMKT 21147 • Available in 3 Star 9L/min as per WELS licence number 0046 	

PRINCESS					
	HF 900P C	Chrome	360.00	<ul style="list-style-type: none"> • ABS 83mm arched single function shower • Full pattern spray • Rub-clean spray diffuser • WaterMark AS 3662 WMKT 21147 • Available in 3 Star 9L/min as per WELS licence number 0046 	

BREEZE					
	HF 900Z C	Chrome	376.00	<ul style="list-style-type: none"> • ABS 104mm arched multi-function shower • Soft, pulsating and bubble spray functions • Rub-clean spray diffuser • Available in 3 Star 9L/min as per WELS licence number 0046 	

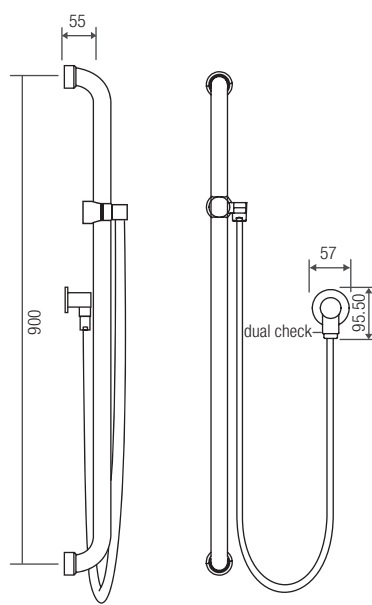

Model shown: HF 900J C

HYGIENIC SEAL® SHOWER KITS

HYGIENIC SEAL® - FRICTION SLIDE 700MM x 1100MM

- 700mm x 1100mm grab rail
- Hygienic Seal® flange with antimicrobial seals
- Licenced dual check/non-return valve
- DR brass wall outlet elbow
- Brass Friction Slide Cradle
- ABS handpiece with rub-clean diffuser
- PVC 1500mm Silverflex™ hose
- Brass 57mm wall flange
- Stainless steel fixings supplied

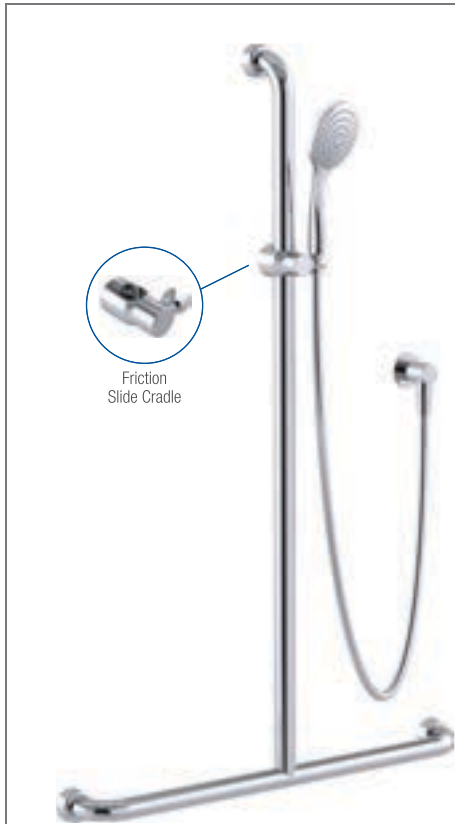

Drawn MF (Middle Fix)

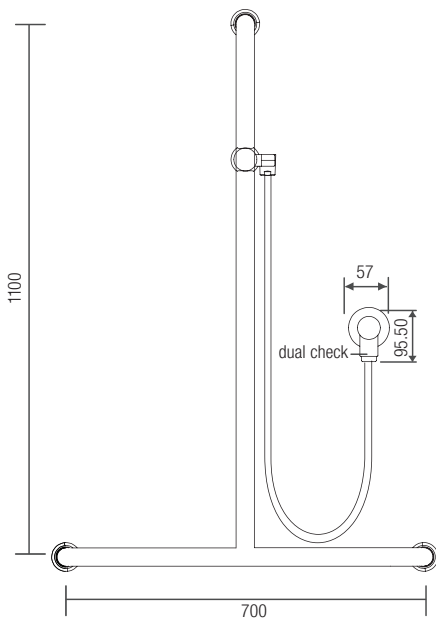

Model shown: HF 071T C MF

Model	Code	Finish	GST Exempt	Features
STREAMJET™				
	HF 071J BN LH	Brushed Nickel	572.00	<ul style="list-style-type: none"> • ABS 100mm single function shower • Concentric full pattern spray • Rub-clean spray diffuser • WaterMark AS 3662 WMKT 21147 • Available in 3 Star 9L/min and 4 Star 6.5L/min as per WELS licence number 0046
	HF 071J BN MF	Brushed Nickel	572.00	
	HF 071J BN RH	Brushed Nickel	572.00	
	HF 071J BN LH/6.5	Brushed Nickel	572.00	
	HF 071J BN MF/6.5	Brushed Nickel	572.00	
	HF 071J BN RH/6.5	Brushed Nickel	572.00	
	HF 071J C LH	Chrome	475.00	
	HF 071J C MF	Chrome	475.00	
	HF 071J C RH	Chrome	475.00	
	HF 071J C LH/6.5	Chrome	475.00	
	HF 071J C MF/6.5	Chrome	475.00	
	HF 071J C RH/6.5	Chrome	475.00	
	HF 071J MB LH	Matte Black	617.00	
	HF 071J MB MF	Matte Black	617.00	
	HF 071J MB RH	Matte Black	617.00	
	HF 071J MB LH/6.5	Matte Black	617.00	
	HF 071J MB MF/6.5	Matte Black	617.00	
	HF 071J MB RH/6.5	Matte Black	617.00	
STREAMJET™ TURBO PULSATOR				
	HF 071T C LH	Chrome	505.00	<ul style="list-style-type: none"> • ABS 100mm multi-function shower • Soft, pulsating and bubble spray • Rub-clean spray diffuser • WaterMark AS 3662 WMKT 21147 • Available in 3 Star 9L/min as per WELS licence number 0046
	HF 071T C MF	Chrome	505.00	
	HF 071T C RH	Chrome	505.00	
STREAMJET™ XL				
	HF 071X BN LH	Brushed Nickel	607.00	<ul style="list-style-type: none"> • ABS 130mm single function shower • Concentric full pattern spray • Rub-clean spray diffuser • WaterMark AS 3662 WMKT 21147 • Available in 3 Star 9L/min as per WELS licence number 0046
	HF 071X BN MF	Brushed Nickel	607.00	
	HF 071X BN RH	Brushed Nickel	607.00	
	HF 071X C LH	Chrome	500.00	
	HF 071X C MF	Chrome	500.00	
	HF 071X C RH	Chrome	500.00	
	HF 071X MB LH	Matte Black	652.00	
	HF 071X MB MF	Matte Black	652.00	
	HF 071X MB RH	Matte Black	652.00	
STREAMJET™ XL TURBO PULSATOR				
	HF 071S C LH	Chrome	530.00	<ul style="list-style-type: none"> • ABS 130mm multi-function shower • Soft, pulsating and bubble spray • Rub-clean spray diffuser • WaterMark AS 3662 WMKT 21147 • Available in 3 Star 9L/min as per WELS licence number 0046
	HF 071S C MF	Chrome	530.00	
	HF 071S C RH	Chrome	530.00	
PRINCESS				
	HF 071P C LH	Chrome	460.00	<ul style="list-style-type: none"> • ABS 83mm arched single function • Full pattern spray • Rub-clean spray diffuser • WaterMark AS 3662 WMKT 21147 • Available in 3 Star 9L/min as per WELS licence number 0046
	HF 071P C MF	Chrome	460.00	
	HF 071P C RH	Chrome	460.00	
BREEZE				
	HF 071Z C LH	Chrome	476.00	<ul style="list-style-type: none"> • ABS 104mm arched multi-function shower • Soft, pulsating and bubble spray • Rub-clean spray diffuser • Available in 3 Star 9L/min as per WELS licence number 0046
	HF 071Z C MF	Chrome	476.00	
	HF 071Z C RH	Chrome	476.00	

HYGIENIC SEAL® INDEPENDENT ACCESSIBLE SHOWER KITS

Independent accessible showers provide ease of access and adjustment for seated users as specified in AS 1428.1:2021, combined with Hygienic Seal® superior grab rails. Made from the highest quality tested materials, Hygienic Seal® accessible showers provide hospitals and aged care facilities with reliable function, practical safety, water efficiency and dual check/non-return as per AS/NZ 3500.



AS 1428.1:2021 Shower Head

An adjustable shower head holder shall be provided to support the shower head and shall allow the graspable portion of the shower head to be positioned at various angles and heights and also allow the graspable portion of the shower head to be located at heights between 1000mm and 1800mm above the plane of the finished floor and allow access and adjustment from a seated position.

The above clause only applies to accessible bathrooms in public buildings, factories, hotels, motels and designated bathrooms in hospitals, homes for the elderly and nursing homes.

Code Finish GST Exempt Features

HYGIENIC SEAL® ACCESSIBLE KIT 3



WITH 1500MM SHOWER HOSE

ID 01803 C	Chrome	382.00
ID 01803 C/6.5	Chrome	382.00
ID 01803 CC	Commercial Chrome	369.00
ID 01803 CC/6.5	Commercial Chrome	369.00

WITH 2000MM SHOWER HOSE

ID 01803 C2	Chrome	387.00
ID 01803 C2/6.5	Chrome	387.00
ID 01803 CC2	Commercial Chrome	374.00
ID 01803 CC2/6.5	Commercial Chrome	374.00

- 1000mm grab rail, centre to centre
- 50mm Hygienic Seal® with Biomaster antimicrobial additive
- Friction Slide handset cradle
- Push-PullMe® shower height adjustment rod
- Hoscare® handpiece with Biomaster antimicrobial additive
- Chrome plated DR brass wall outlet elbow
- Flow Interchange® spigot
- Licenced dual check/non-return as per WaterMark AS/NZS 2845.1 WMKA 02696
- 57mm solid brass round flat flange
- Silverflex PVC shower hose
- WaterMark AS/NZS 3662 WMKT 21147
- Available in 3 Star 9L/min and 4 Star 6.5L/min as per WELS licence number 0046
- Meets the requirements of AS 1428.1:2021 Design for access and mobility



Options available on request

- ABS Grab Rail Soap Dish Holder - see page 94

HYGIENIC SEAL® ACCESSIBLE KIT 20

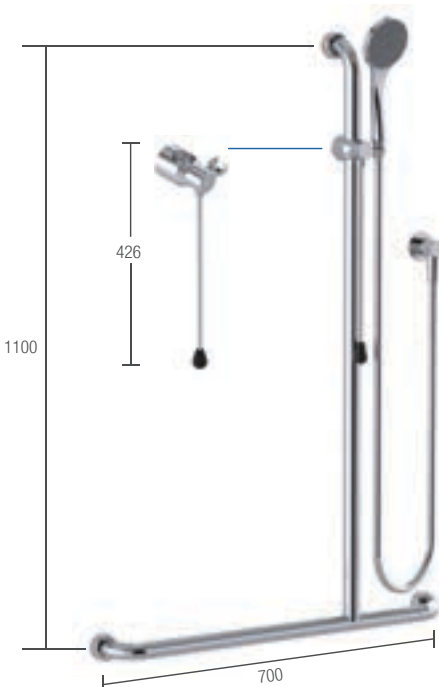

WITH 1500MM SHOWER HOSE

ID 01820 C LH	Chrome	477.00
ID 01820 C RH	Chrome	477.00
ID 01820 C LH/6.5	Chrome	477.00
ID 01820 C RH/6.5	Chrome	477.00

ID 01820 CC LH	Commercial Chrome	447.00
ID 01820 CC RH	Commercial Chrome	447.00
ID 01820 CC LH/6.5	Commercial Chrome	447.00
ID 01820 CC RH/6.5	Commercial Chrome	447.00

WITH 2000MM SHOWER HOSE

ID 01820 C2 LH	Chrome	482.00
ID 01820 C2 RH	Chrome	482.00
ID 01820 C2 LH/6.5	Chrome	482.00
ID 01820 C2 RH/6.5	Chrome	482.00

ID 01820 CC2 LH	Commercial Chrome	452.00
ID 01820 CC2 RH	Commercial Chrome	452.00
ID 01820 CC2 LH/6.5	Commercial Chrome	452.00
ID 01820 CC2 RH/6.5	Commercial Chrome	452.00

- 700mm x 1100mm grab rail, centre to centre
- 32mm grab rail fabricated from 304 stainless steel
- 50mm Hygienic Seal® with Biomaster antimicrobial additive
- Friction Slide handset cradle
- Push-PullMe® shower height adjustment rod
- Hoscare® handpiece with Biomaster antimicrobial additive care
- Chrome plated DR brass wall outlet elbow
- Flow Interchange® spigot
- Licenced dual check/non-return as per WaterMark AS/NZS 2845.1 WMKA 02696
- 57mm solid brass round flat flange
- Silverflex PVC shower hose
- WaterMark AS/NZS 3662 WMKT 21147
- Available in 3 Star 9L/min and 4 Star 6.5L/min as per WELS licence number 0046
- Meets the requirements of AS 1428.1:2021 Design for access and mobility



Options available on request

- ABS Grab Rail Soap Dish Holder - see page 94

HYGIENIC SEAL® COMMERCIAL SHOWER KITS

Hygienic Seal® healthcare showers are made from quality materials and feature dual check facilities as per AS/NZ 3500. All kits include Hygienic Seal® 32mm grab rails assembled with 50mm flange covers featuring Biomaster Thermoplastic Elastomer (TPE) seals, and are WELS rated as per licence number 0046.

	Code	Finish	GST Exempt	Features		
HYGIENIC SEAL® SHOWER KIT 3						
 <p>Friction Slide Cradle</p>	WITH 1500MM SHOWER HOSE			<ul style="list-style-type: none"> • 900mm grab rail, centre to centre • 50mm Hygienic Seal® with Biomaster antimicrobial additive • Friction Slide handset cradle • Hoscare® handpiece with Biomaster antimicrobial additive • Chrome plated DR brass wall outlet elbow • Flow Interchange® spigot • Licenced dual check/non-return as per WaterMark AS/NZS 2845.1 WMKA 02696 • 57mm solid brass round flat flange • Silverflex PVC shower hose • WaterMark AS/NZS 3662 WMKT 21147 • Available in 3 Star 9L/min and 4 Star 6.5L/min as per WELS licence number 0046 • Meets the requirements of AS 1428.1:2021 Design for access and mobility    <p>Options available on request</p> <ul style="list-style-type: none"> • ABS Grab Rail Soap Dish Holder - see page 94 		
	HS 01803 C	Chrome	345.00			
	HS 01803 C/6.5	Chrome	345.00			
	HS 01803 CC	Commercial Chrome	330.00			
	HS 01803 CC/6.5	Commercial Chrome	330.00			
	WITH 2000MM SHOWER HOSE					
	HS 01803 C2	Chrome	350.00			
	HS 01803 C2/6.5	Chrome	350.00			
	HS 01803 CC2	Commercial Chrome	335.00			
	HS 01803 CC2/6.5	Commercial Chrome	335.00			
	HYGIENIC SEAL® SHOWER KIT 9					
	 <p>ABS Glide Slide Cradle</p>	WITH 1500MM SHOWER HOSE			<ul style="list-style-type: none"> • 900mm grab rail, centre to centre • 50mm Hygienic Seal® with Biomaster antimicrobial additive • ABS Glide Slide handset cradle • Hoscare® handpiece with Biomaster antimicrobial additive • Chrome plated DR brass wall outlet elbow • Flow Interchange® spigot • Licenced dual check/non-return as per WaterMark AS/NZS 2845.1 WMKA 02696 • 57mm solid brass round flat flange • Silverflex PVC shower hose • WaterMark AS/NZS 3662 WMKT 21147 • Available in 3 Star 9L/min and 4 Star 6.5L/min as per WELS licence number 0046 • Meets the requirements of AS 1428.1:2021 Design for access and mobility    <p>Options available on request</p> <ul style="list-style-type: none"> • ABS Grab Rail Soap Dish Holder - see page 94 	
HS 01809 C		Chrome	277.00			
HS 01809 C/6.5		Chrome	277.00			
HS 01809 CC		Commercial Chrome	262.00			
HS 01809 CC/6.5		Commercial Chrome	262.00			
WITH 2000MM SHOWER HOSE						
HS 01809 C2		Chrome	282.00			
HS 01809 C2/6.5		Chrome	282.00			
HS 01809 CC2		Commercial Chrome	267.00			
HS 01809 CC2/6.5		Commercial Chrome	267.00			

HYGIENIC SEAL® COMMERCIAL SHOWER KITS

Hygienic Seal® healthcare showers are made from quality materials and feature dual check facilities as per AS/NZ 3500. All kits include Hygienic Seal® 32mm grab rails assembled with 50mm flange covers featuring Biomaster Thermoplastic Elastomer (TPE) seals, and are WELS rated as per licence number 0046.



Code Finish GST Exempt Features

HYGIENIC SEAL® SHOWER KIT 5

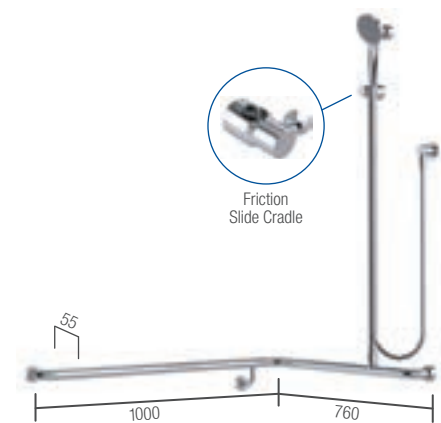

Drawn RH (Right Hand)



Drawn LH (Left Hand)

HS 01805 C LH	Chrome	590.00
HS 01805 C LH/6.5	Chrome	590.00
HS 01805 C RH	Chrome	590.00
HS 01805 C RH/6.5	Chrome	590.00
HS 01805 CC LH	Commercial Chrome	510.00
HS 01805 CC LH/6.5	Commercial Chrome	510.00
HS 01805 CC RH	Commercial Chrome	510.00
HS 01805 CC RH/6.5	Commercial Chrome	510.00

- 760mm x 1000mm x 1100mm grab rail
- 32mm grab rail fabricated from 304 stainless steel
- 50mm Hygienic Seal® with Biomaster antimicrobial additive
- Friction Slide handset cradle
- Hoscare® handpiece with Biomaster antimicrobial additive
- Chrome plated DR brass wall outlet elbow
- Flow Interchange® spigot
- Licenced dual check/non-return as per WaterMark AS/NZS 2845.1 WMKA 02696
- 57mm solid brass round flat flange
- 1500mm Silverflex PVC shower hose
- Available in 3 Star 9L/min and 4 Star 6.5L/min as per WELS licence number 0046
- Meets the requirements of AS 1428.1:2021 Design for access and mobility



Options available on request

- ABS Grab Rail Soap Dish Holder - see page 94

HYGIENIC SEAL® SHOWER KIT 13

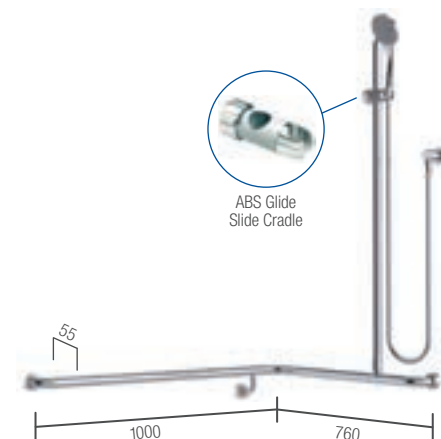

Drawn RH (Right Hand)



Drawn LH (Left Hand)

HS 01813 C LH	Chrome	522.00
HS 01813 C LH/6.5	Chrome	522.00
HS 01813 C RH	Chrome	522.00
HS 01813 C RH/6.5	Chrome	522.00
HS 01813 CC LH	Commercial Chrome	442.00
HS 01813 CC LH/6.5	Commercial Chrome	442.00
HS 01813 CC RH	Commercial Chrome	442.00
HS 01813 CC RH/6.5	Commercial Chrome	442.00

- 900mm grab rail
- 32mm grab rail fabricated from 304 stainless steel
- 50mm Hygienic Seal® with Biomaster antimicrobial additive
- ABS Glide Slide handset cradle
- Hoscare® handpiece with Biomaster antimicrobial additive
- Chrome plated DR brass wall outlet elbow
- Flow Interchange® spigot
- Licenced dual check/non-return as per WaterMark AS/NZS 2845.1 WMKA 02696
- 57mm solid brass round flat flange
- 1500mm Silverflex PVC shower hose
- WaterMark AS/NZS 3662 WMKT 21147
- Available in 3 Star 9L/min and 4 Star 6.5L/min as per WELS licence number 0046
- Meets the requirements of AS 1428.1:2021 Design for access and mobility









Options available on request

- ABS Grab Rail Soap Dish Holder - see page 94

HYGIENIC SEAL® COMMERCIAL SHOWER KITS

Hygienic Seal® healthcare showers are made from quality materials and feature dual check facilities as per AS/NZ 3500. All kits include Hygienic Seal® 32mm grab rails assembled with 50mm flange covers featuring Biomaster Thermoplastic Elastomer (TPE) seals, and are WELS rated as per licence number 0046.

	Code	Finish	GST Exempt	Features	
HYGIENIC SEAL® SHOWER KIT 20					
<p>1100</p> <p>700</p> <p>55</p> <p>Friction Slide Cradle</p>	HS 01820 C LH	Chrome	445.00	<ul style="list-style-type: none"> • 700mm x 1100mm grab rail • 32mm grab rail fabricated from 304 stainless steel • 50mm Hygienic Seal® with Biomaster antimicrobial additive • Friction Slide handset cradle • Hoscare® handpiece with Biomaster antimicrobial additive • Chrome plated DR brass wall outlet elbow • Flow Interchange® spigot • Licenced dual check/non-return as per WaterMark AS/NZS 2845.1 WMKA 02696 • 57mm solid brass round flat flange • 1500mm Silverflex PVC shower hose • WaterMark AS/NZS 3662 WMKT 21147 • Available in 3 Star 9L/min and 4 Star 6.5L/min as per WELS licence number 0046 • Meets the requirements of AS 1428.1:2021 Design for access and mobility    <p>Options available on request</p> <ul style="list-style-type: none"> • ABS Grab Rail Soap Dish Holder - see page 94 	
	HS 01820 C RH	Chrome	445.00		
	HS 01820 C/6.5 LH	Chrome	445.00		
	HS 01820 C/6.5 RH	Chrome	445.00		
	HS 01820 CC LH	Commercial Chrome	415.00		
	HS 01820 CC RH	Commercial Chrome	415.00		
	HS 01820 CC/6.5 LH	Commercial Chrome	415.00		
	HS 01820 CC/6.5 RH	Commercial Chrome	415.00		
HYGIENIC SEAL® SHOWER KIT 16					
<p>1100</p> <p>700</p> <p>55</p> <p>ABS Glide Slide Cradle</p>	HS 01816 C LH	Chrome	377.00		<ul style="list-style-type: none"> • 700mm x 1100mm grab rail • 32mm grab rail fabricated from 304 stainless steel • 50mm Hygienic Seal® with Biomaster antimicrobial additive • ABS Glide Slide handset cradle • Hoscare® handpiece with Biomaster antimicrobial additive • Chrome plated DR brass wall outlet elbow • Flow Interchange® spigot • Licenced dual check/non-return as per WaterMark AS/NZS 2845.1 WMKA 02696 • 57mm solid brass round flat flange • 1500mm Silverflex PVC shower hose • WaterMark AS/NZS 3662 WMKT 21147 • Available in 3 Star 9L/min and 4 Star 6.5L/min as per WELS licence number 0046 • Meets the requirements of AS 1428.1:2021 Design for access and mobility    <p>Options available on request</p> <ul style="list-style-type: none"> • ABS Grab Rail Soap Dish Holder - see page 94
	HS 01816 C RH	Chrome	377.00		
	HS 01816 C/6.5 LH	Chrome	377.00		
	HS 01816 C/6.5 RH	Chrome	377.00		
	HS 01816 CC LH	Commercial Chrome	347.00		
	HS 01816 CC RH	Commercial Chrome	347.00		
	HS 01816 CC/6.5 LH	Commercial Chrome	347.00		
	HS 01816 CC/6.5 RH	Commercial Chrome	347.00		

LINEAR GRAB RAILS - TOWEL GRAB RAILS & ACCESSIBLE TOILET ASSIST



Biomaster antimicrobial seals for added protection against bacteria

Con-Serv's superior grab rail range, the Linear combines the quality of the Hygienic Seal® grab rail with the classic profile of a 'T' leg linear flange delivering both style and sophistication. Ideal in domestic and commercial environments, Linear grab rails are available in a variety of sizes and finishes.













	Code	Finish	GST Exempt	Features
LINEAR TOWEL GRAB RAILS "D" SHAPE				
	LT 600 BS D	Brushed Stainless	150.00	<ul style="list-style-type: none"> 600mm and 800mm towel grab rails, centre to centre 32mm grab rail fabricated from 304 stainless steel Assembled with matching 50mm brass screw on flange covers featuring TPE (Thermoplastic Elastomer) fitted seals Stainless steel fixing screws supplied
	LT 600 MB D	Matte Black	210.00	
	LT 600 PS D	Polish Supreme™	165.00	
	LT 800 BS D	Brushed Stainless	170.00	
	LT 800 MB D	Matte Black	230.00	
	LT 800 PS D	Polish Supreme™	190.00	
LINEAR TOWEL GRAB RAILS "U" SHAPE				
	LT 600 BS U	Brushed Stainless	160.00	<ul style="list-style-type: none"> 600mm and 800mm towel grab rails, centre to centre 32mm grab rail fabricated from 304 stainless steel Assembled with matching 50mm brass screw on flange covers featuring TPE (Thermoplastic Elastomer) fitted seals Stainless steel fixing screws supplied Meets the requirements of AS 1428.1:2021 Design for access and mobility
	LT 600 MB U	Matte Black	220.00	
	LT 600 PS U	Polish Supreme™	175.00	
	LT 800 BS U	Brushed Stainless	180.00	
	LT 800 MB U	Matte Black	240.00	
	LT 800 PS U	Polish Supreme™	190.00	
LINEAR 40° AMBULANT AND ACCESSIBLE GRAB RAILS 450MM X 450MM				
	LR 045 BS LH	Brushed Stainless	180.00	<ul style="list-style-type: none"> 450mm x 450mm 32mm grab rail fabricated from 304 stainless steel Assembled with 50mm brass screw on flange covers with Biomaster Thermoplastic Elastomer (TPE) fitted seals Stainless steel fixing screws supplied Meets the requirements of AS 1428.1:2021 Design for access and mobility
	LR 045 BS RH	Brushed Stainless	180.00	
	LR 045 MB LH	Matte Black	250.00	
	LR 045 MB RH	Matte Black	250.00	
	LR 045 PS LH	Polish Supreme™	198.00	
	LR 045 PS RH	Polish Supreme™	198.00	
LINEAR 40° AMBULANT AND ACCESSIBLE GRAB RAILS 870MM X 700MM				
	LR 877 BS LH	Brushed Stainless	240.00	<ul style="list-style-type: none"> 870mm x 700mm 32mm grab rail fabricated from 304 stainless steel Assembled with 50mm brass screw on flange covers with Biomaster Thermoplastic Elastomer (TPE) fitted seals Stainless steel fixing screws supplied Meets the requirements of AS 1428.1:2021 Design for access and mobility
	LR 877 BS RH	Brushed Stainless	240.00	
	LR 877 MB LH	Matte Black	310.00	
	LR 877 MB RH	Matte Black	310.00	
	LR 877 PS LH	Polish Supreme™	265.00	
	LR 877 PS RH	Polish Supreme™	265.00	
LINEAR 90° AMBULANT AND ACCESSIBLE GRAB RAILS 450MM X 450MM				
	LR 454 BS LH	Brushed Stainless	180.00	<ul style="list-style-type: none"> 450mm x 450mm 32mm grab rail fabricated from 304 stainless steel Assembled with 50mm brass screw on flange covers with Biomaster Thermoplastic Elastomer (TPE) fitted seals Stainless steel fixing screws supplied Meets the requirements of AS 1428.1:2021 Design for access and mobility
	LR 454 BS RH	Brushed Stainless	180.00	
	LR 454 MB LH	Matte Black	250.00	
	LR 454 MB RH	Matte Black	250.00	
	LR 454 PS LH	Polish Supreme™	198.00	
	LR 454 PS RH	Polish Supreme™	198.00	
LINEAR 90° AMBULANT AND ACCESSIBLE GRAB RAILS 960MM X 600MM				
	LR 966 BS LH	Brushed Stainless	240.00	<ul style="list-style-type: none"> 960mm x 600mm 32mm grab rail fabricated from 304 stainless steel Assembled with 50mm brass screw on flange covers with Biomaster Thermoplastic Elastomer (TPE) fitted seals Stainless steel fixing screws supplied Meets the requirements of AS 1428.1:2021 Design for access and mobility
	LR 966 BS RH	Brushed Stainless	240.00	
	LR 966 MB LH	Matte Black	310.00	
	LR 966 MB RH	Matte Black	310.00	
	LR 966 PS LH	Polish Supreme™	265.00	
	LR 966 PS RH	Polish Supreme™	265.00	

All dimensions are in millimetres unless otherwise specified.

LINEAR SHOWER - 900MM

- 900mm grab rail
- Meets requirements of AS 1428.1:2021
- Hygienic Seal® flange with antimicrobial seals
- DR brass wall outlet elbow
- Brass Friction Slide Cradle
- ABS handpiece with rub-clean diffuser
- PVC 1500mm Silverflex™ hose
- Licenced dual check/non-return valve
- Brass 57mm wall flange
- Stainless steel fixings supplied



Model	Code	Finish	GST Exempt	Features	
STREAMJET™					
	LF 900J BN	Brushed Nickel	557.00	<ul style="list-style-type: none"> • ABS 100mm single function shower • Concentric full pattern spray • Rub-clean spray diffuser • WaterMark AS 3662 WMKT 21147 • Available in 3 Star 9L/min and 4 Star 6.5L/min as per WELS licence number 0046 	
	LF 900J BN/6.5	Brushed Nickel	557.00		
	LF 900J C	Chrome	465.00		
	LF 900J C/6.5	Chrome	465.00		
	LF 900J MB	Matte Black	597.00		
	LF 900J MB/6.5	Matte Black	597.00		
STREAMJET™ TURBO PULSATOR					
	LF 900T C	Chrome	495.00	<ul style="list-style-type: none"> • ABS 100mm multi-function shower • Soft, pulsating and bubble spray functions • Rub-clean spray diffuser • WaterMark AS 3662 WMKT 21147 • Available in 3 Star 9L/min as per WELS licence number 0046 	
STREAMJET™ XL					
	LF 900X BN	Brushed Nickel	592.00	<ul style="list-style-type: none"> • ABS 130mm single function shower • Concentric full pattern spray • Rub-clean spray diffuser • WaterMark AS 3662 WMKT 21147 • Available in 3 Star 9L/min as per WELS licence number 0046 	
	LF 900X C	Chrome	490.00		
	LF 900X MB	Matte Black	632.00		
STREAMJET™ XL TURBO PULSATOR					
	LF 900S C	Chrome	520.00	<ul style="list-style-type: none"> • ABS 130mm multi-function shower • Soft, pulsating and bubble spray functions • Rub-clean spray diffuser • WaterMark AS 3662 WMKT 21147 • Available in 3 Star 9L/min as per WELS licence number 0046 	
PRINCESS					
	LF 900P C	Chrome	450.00	<ul style="list-style-type: none"> • ABS 83mm arched single function shower • Full pattern spray • Rub-clean spray diffuser • WaterMark AS 3662 WMKT 21147 • Available in 3 Star 9L/min as per WELS licence number 0046 	
BREEZE					
	LF 900Z C	Chrome	466.00	<ul style="list-style-type: none"> • ABS 104mm arched multi-function shower • Soft, pulsating and bubble spray functions • Rub-clean spray diffuser • Available in 3 Star 9L/min as per WELS licence number 0046 	

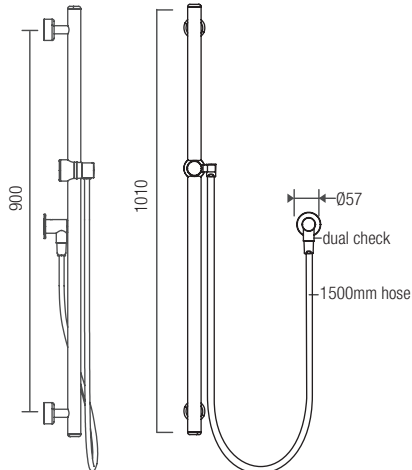
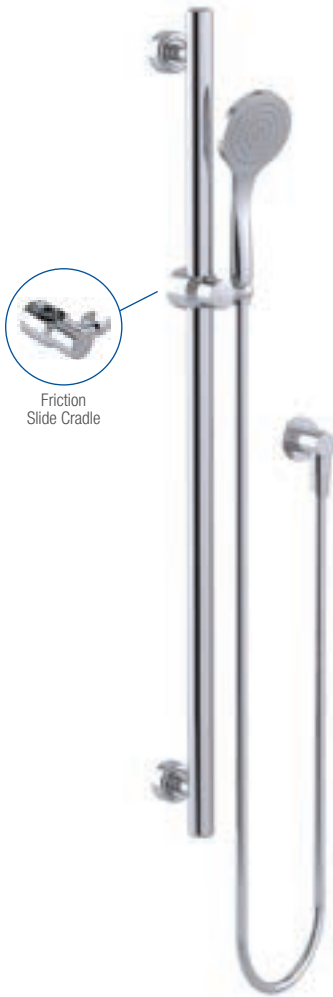







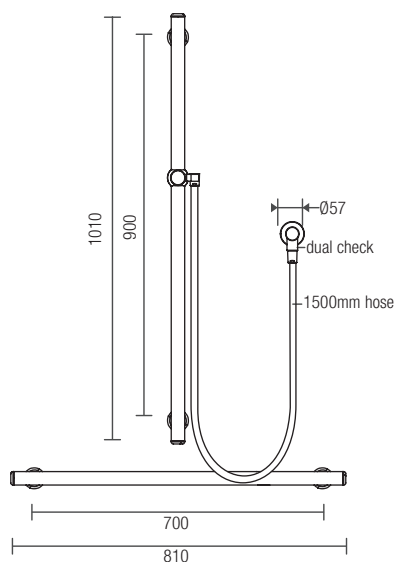





Model shown: LF 900J C

LINEAR SHOWER - 900MM & 700MM

- 700mm & 900mm grab rails
- Meets requirements of AS 1428.1:2021
- Hygienic Seal® flange with antimicrobial seals
- DR brass wall outlet elbow
- Brass Friction Slide Cradle
- ABS handpiece with rub-clean diffuser
- PVC 1500mm Silverflex™ hose
- Licenced dual check/non-return valve
- Brass 57mm wall flange
- Stainless steel fixings supplied



Model shown: LF 079J C

Model	Code	Finish	GST Exempt	Features	
STREAMJET™					
	LF 079J BN	Brushed Nickel	682.00	<ul style="list-style-type: none"> • ABS 100mm single function shower • Concentric full pattern spray • Rub-clean spray diffuser • WaterMark AS 3662 WMKT 21147 • Available in 3 Star 9L/min and 4 Star 6.5L/min as per WELS licence number 0046 	
	LF 079J BN/6.5	Brushed Nickel	682.00		
	LF 079J C	Chrome	620.00		
	LF 079J C/6.5	Chrome	620.00		
	LF 079J MB	Matte Black	787.00		
	LF 079J MB/6.5	Matte Black	787.00		
STREAMJET™ TURBO PULSATOR					
	LF 079T C	Chrome	650.00	<ul style="list-style-type: none"> • ABS 100mm multi-function shower • Soft, pulsating and bubble spray functions • Rub-clean spray diffuser • WaterMark AS 3662 WMKT 21147 • Available in 3 Star 9L/min as per WELS licence number 0046 	
STREAMJET™ XL					
	LF 079X BN	Brushed Nickel	717.00	<ul style="list-style-type: none"> • ABS 130mm single function shower • Concentric full pattern spray • Rub-clean spray diffuser • WaterMark AS 3662 WMKT 21147 • Available in 3 Star 9L/min as per WELS licence number 0046 	
	LF 079X C	Chrome	645.00		
	LF 079X MB	Matte Black	822.00		
STREAMJET™ XL TURBO PULSATOR					
	LF 079S C	Chrome	675.00	<ul style="list-style-type: none"> • ABS 130mm multi-function shower • Soft, pulsating and bubble spray functions • Rub-clean spray diffuser • WaterMark AS 3662 WMKT 21147 • Available in 3 Star 9L/min as per WELS licence number 0046 	
PRINCESS					
	LF 079P C	Chrome	605.00	<ul style="list-style-type: none"> • ABS 83mm arched single function shower • Full pattern spray • Rub-clean spray diffuser • WaterMark AS 3662 WMKT 21147 • Available in 3 Star 9L/min as per WELS licence number 0046 	
BREEZE					
	LF 079Z C	Chrome	621.00	<ul style="list-style-type: none"> • ABS 104mm arched multi-function shower • Soft, pulsating and bubble spray functions • Rub-clean spray diffuser • Available in 3 Star 9L/min as per WELS licence number 0046 	

LINEAR TWIN WATERS™ - 450MM

- 1100mm grab rail
- Stainless steel 400mm swivelling shower arm
- Meets requirements of AS 1428.1:2021
- ABS 256mm rainmaker shower
- ABS handpiece with rub-clean diffuser

- PVC 1500mm Silverflex™ hose
- Diverter switchcock valve
- Licenced dual check/non-return valve
- Stainless steel fixings supplied



Model Code Finish GST Exempt Features



STREAMJET™			
TOP INLET			
	LT 110CJ BN 45	Brushed Nickel	1015.00
	LT 110CJ C 45	Chrome	905.00
BOTTOM INLET			
	LT 111CJ BN 45	Brushed Nickel	1015.00
	LT 111CJ C 45	Chrome	905.00

- ABS 100mm single function shower
- Concentric full pattern spray
- Rub-clean spray diffuser
- WaterMark AS 3662 WMKT 21147
- Available in 3 Star 9L/min and 4 Star 6.5L/min as per WELS licence number 0046



STREAMJET™ TURBO PULSATOR			
TOP INLET			
	LT 110CT C 45	Chrome	935.00
BOTTOM INLET			
	LT 111CT C 45	Chrome	935.00

- ABS 100mm multi-function shower
- Soft, pulsating and bubble spray functions
- Rub-clean spray diffuser
- WaterMark AS 3662 WMKT 21147
- Available in 3 Star 9L/min as per WELS licence number 0046



STREAMJET™ XL			
TOP INLET			
	LT 110CX BN 45	Brushed Nickel	1050.00
	LT 110CX C 45	Chrome	930.00
BOTTOM INLET			
	LT 111CX BN 45	Brushed Nickel	1050.00
	LT 111CX C 45	Chrome	930.00

- ABS 130mm single function shower
- Concentric full pattern spray
- Rub-clean spray diffuser
- WaterMark AS 3662 WMKT 21147
- Available in 3 Star 9L/min as per WELS licence number 0046



STREAMJET™ XL TURBO PULSATOR			
TOP INLET			
	LT 110CS C 45	Chrome	960.00
BOTTOM INLET			
	LT 111CS C 45	Chrome	960.00

- ABS 130mm multi-function shower
- Soft, pulsating and bubble spray functions
- Rub-clean spray diffuser
- WaterMark AS 3662 WMKT 21147
- Available in 3 Star 9L/min as per WELS licence number 0046



PRINCESS			
TOP INLET			
	LT 110CP C 45	Chrome	890.00
BOTTOM INLET			
	LT 111CP C 45	Chrome	890.00

- ABS 83mm arched single function shower
- Full pattern spray
- Rub-clean spray diffuser
- WaterMark AS 3662 WMKT 21147
- Available in 3 Star 9L/min as per WELS licence number 0046



BREEZE			
TOP INLET			
	LT 110CZ C 45	Chrome	906.00
BOTTOM INLET			
	LT 111CZ C 45	Chrome	906.00

- ABS 104mm arched multi-function shower
- Soft, pulsating and bubble spray functions
- Rub-clean spray diffuser
- Available in 3 Star 9L/min as per WELS licence number 0046



Model shown: LT 110CP C 45

LINEAR TWIN WATERS™ - 650MM

- 1100mm grab rail
- Stainless steel 600mm swivelling shower arm
- Meets requirements of AS 1428.1:2021
- ABS 256mm rainmaker shower
- ABS handpiece with rub-clean diffuser
- PVC 1500mm Silverflex™ hose
- Diverter switchcock valve
- Licenced dual check/non-return valve
- Stainless steel fixings supplied

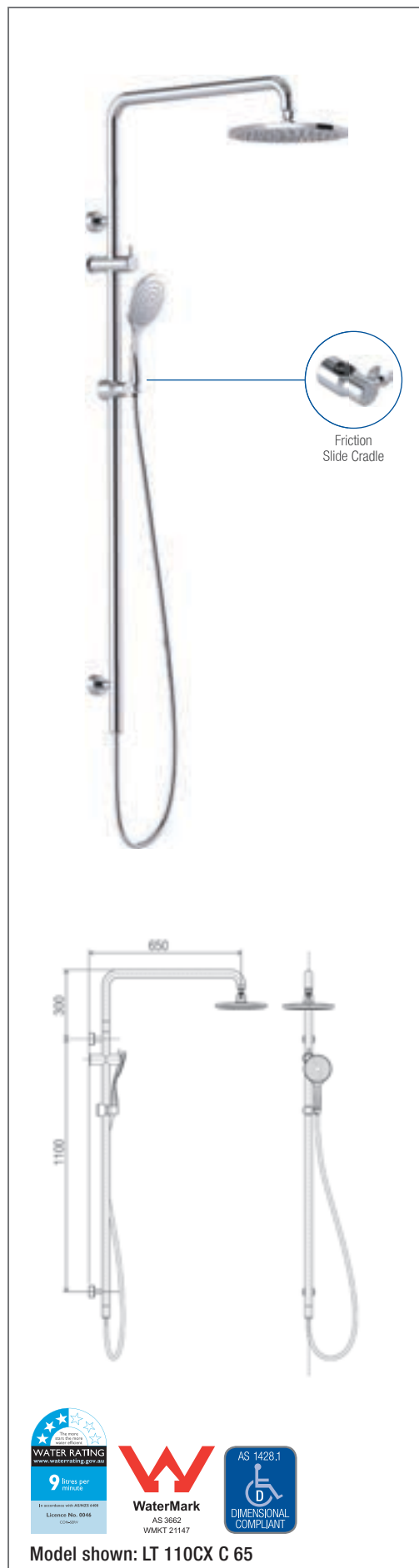

Model	Code	Finish	GST Exempt	Features
STREAMJET™				
TOP INLET				<ul style="list-style-type: none"> • ABS 100mm single function shower • Concentric full pattern spray • Rub-clean spray diffuser • WaterMark AS 3662 WMKT 21147 • Available in 3 Star 9L/min and 4 Star 6.5L/min as per WELS licence number 0046 
	LT 110CJ BN 65	Brushed Nickel	1045.00	
	LT 110CJ C 65	Chrome	935.00	
BOTTOM INLET				
	LT 111CJ BN 65	Brushed Nickel	1045.00	
	LT 111CJ C 65	Chrome	935.00	
STREAMJET™ TURBO PULSATOR				
TOP INLET				<ul style="list-style-type: none"> • ABS 100mm multi-function shower • Soft, pulsating and bubble spray functions • Rub-clean spray diffuser • WaterMark AS 3662 WMKT 21147 • Available in 3 Star 9L/min as per WELS licence number 0046 
	LT 110CT C 65	Chrome	965.00	
BOTTOM INLET				
	LT 111CT C 65	Chrome	965.00	
STREAMJET™ XL				
TOP INLET				<ul style="list-style-type: none"> • ABS 130mm single function shower • Concentric full pattern spray • Rub-clean spray diffuser • WaterMark AS 3662 WMKT 21147 • Available in 3 Star 9L/min as per WELS licence number 0046 
	LT 110CX BN 65	Brushed Nickel	1080.00	
	LT 110CX C 65	Chrome	960.00	
BOTTOM INLET				
	LT 111CX BN 65	Brushed Nickel	1080.00	
	LT 111CX C 65	Chrome	960.00	
STREAMJET™ XL TURBO PULSATOR				
TOP INLET				<ul style="list-style-type: none"> • ABS 130mm multi-function shower • Soft, pulsating and bubble spray functions • Rub-clean spray diffuser • WaterMark AS 3662 WMKT 21147 • Available in 3 Star 9L/min as per WELS licence number 0046 
	LT 110CS C 65	Chrome	990.00	
BOTTOM INLET				
	LT 111CS C 65	Chrome	990.00	
PRINCESS				
TOP INLET				<ul style="list-style-type: none"> • ABS 83mm arched single function shower • Full pattern spray • Rub-clean spray diffuser • WaterMark AS 3662 WMKT 21147 • Available in 3 Star 9L/min as per WELS licence number 0046 
	LT 110CP C 65	Chrome	920.00	
BOTTOM INLET				
	LT 111CP C 65	Chrome	920.00	
BREEZE				
TOP INLET				<ul style="list-style-type: none"> • ABS 104mm arched multi-function shower • Soft, pulsating and bubble spray functions • Rub-clean spray diffuser • Available in 3 Star 9L/min as per WELS licence number 0046 
	LT 110CZ C 65	Chrome	936.00	
BOTTOM INLET				
	LT 111CZ C 65	Chrome	936.00	



Model shown: LT 110CX C 65

LINEAR TWIN WATERS™ - INVERTED "T" 450MM

- 700mm x 1100mm grab rail
- Stainless steel 400mm swivelling shower arm
- Meets requirements of AS 1428.1:2021
- ABS 256mm rainmaker shower
- ABS handpiece with rub-clean diffuser
- PVC 1500mm Silverflex™ hose
- Diverter switchcock valve
- Licenced dual check/non-return valve
- Stainless steel fixings supplied



Drawn RH (Right Hand)

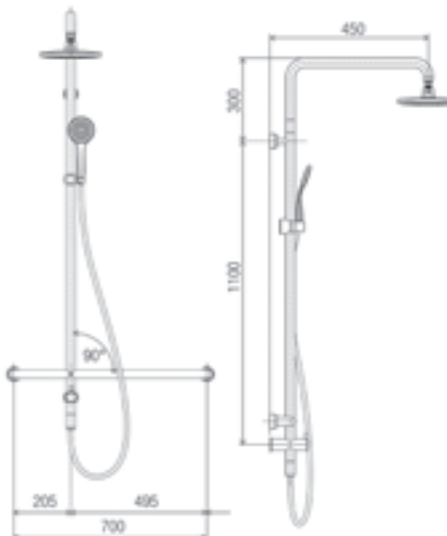

Model	Code	Finish	GST Exempt	Features
STREAMJET™				
	LT 071CJ BN L45	Brushed Nickel	1055.00	<ul style="list-style-type: none"> • ABS 100mm single function shower • Concentric full pattern spray • Rub-clean spray diffuser • WaterMark AS 3662 WMKT 21147 • Available in 3 Star 9L/min and 4 Star 6.5L/min as per WELS licence number 0046
	LT 071CJ BN M45	Brushed Nickel	1055.00	
	LT 071CJ BN R45	Brushed Nickel	1055.00	
	LT 071CJ C L45	Chrome	945.00	
	LT 071CJ C M45	Chrome	945.00	
	LT 071CJ C R45	Chrome	945.00	
STREAMJET™ TURBO PULSATOR				
	LT 071CT C L45	Chrome	975.00	<ul style="list-style-type: none"> • ABS 100mm multi-function shower • Soft, pulsating and bubble spray functions • Rub-clean spray diffuser • WaterMark AS 3662 WMKT 21147 • Available in 3 Star 9L/min as per WELS licence number 0046
	LT 071CT C M45	Chrome	975.00	
	LT 071CT C R45	Chrome	975.00	
STREAMJET™ XL				
	LT 071CX BN L45	Brushed Nickel	1090.00	<ul style="list-style-type: none"> • ABS 130mm single function shower • Concentric full pattern spray • Rub-clean spray diffuser • WaterMark AS 3662 WMKT 21147 • Available in 3 Star 9L/min as per WELS licence number 0046
	LT 071CX BN M45	Brushed Nickel	1090.00	
	LT 071CX BN R45	Brushed Nickel	1090.00	
	LT 071CX C L45	Chrome	970.00	
	LT 071CX C M45	Chrome	970.00	
	LT 071CX C R45	Chrome	970.00	
STREAMJET™ XL TURBO PULSATOR				
	LT 071CS C L45	Chrome	1000.00	<ul style="list-style-type: none"> • ABS 130mm multi-function shower • Soft, pulsating and bubble spray functions • Rub-clean spray diffuser • WaterMark AS 3662 WMKT 21147 • Available in 3 Star 9L/min as per WELS licence number 0046
	LT 071CS C M45	Chrome	1000.00	
	LT 071CS C R45	Chrome	1000.00	
PRINCESS				
	LT 071CP C L45	Chrome	930.00	<ul style="list-style-type: none"> • ABS 83mm arched single function shower • Full pattern spray • Rub-clean spray diffuser • WaterMark AS 3662 WMKT 21147 • Available in 3 Star 9L/min as per WELS licence number 0046
	LT 071CP C M45	Chrome	930.00	
	LT 071CP C R45	Chrome	930.00	
BREEZE				
	LT 071CZ C L45	Chrome	946.00	<ul style="list-style-type: none"> • ABS 104mm arched multi-function shower • Soft, pulsating and bubble spray functions • Rub-clean spray diffuser • Available in 3 Star 9L/min as per WELS licence number 0046
	LT 071CZ C M45	Chrome	946.00	
	LT 071CZ C R45	Chrome	946.00	



Model shown: LT 071CJ C R45

LINEAR TWIN WATERS™ - INVERTED "T" 650MM

- 700mm x 1100mm Polish Supreme™ grab rail
- Stainless steel 600mm swivelling shower arm
- Meets requirements of AS 1428.1:2021
- ABS 256mm rainmaker shower
- ABS handpiece with rub-clean diffuser
- PVC 1500mm Silverflex™ hose
- Diverter switchcock valve
- Licenced dual check/non-return valve
- Stainless steel fixings supplied





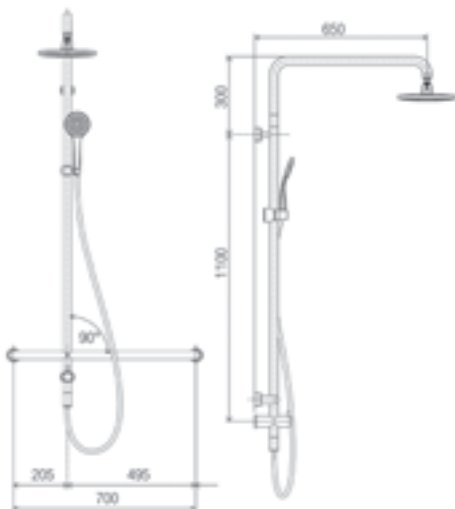







Drawn LH (Left Hand)



Model shown: LT 071CJ C L65







Model	Code	Finish	GST Exempt	Features
STREAMJET™				
	LT 071CJ BN L65	Brushed Nickel	1085.00	<ul style="list-style-type: none"> • ABS 100mm single function shower • Concentric full pattern spray • Rub-clean spray diffuser • WaterMark AS 3662 WMKT 21147 • Available in 3 Star 9L/min and 4 Star 6.5L/min as per WELS licence number 0046
	LT 071CJ BN M65	Brushed Nickel	1085.00	
	LT 071CJ BN R65	Brushed Nickel	1085.00	
	LT 071CJ C L65	Chrome	975.00	
	LT 071CJ C M65	Chrome	975.00	
	LT 071CJ C R65	Chrome	975.00	
STREAMJET™ TURBO PULSATOR				
	LT 071CT C L65	Chrome	1005.00	<ul style="list-style-type: none"> • ABS 100mm multi-function shower • Soft, pulsating and bubble spray functions • Rub-clean spray diffuser • WaterMark AS 3662 WMKT 21147 • Available in 3 Star 9L/min as per WELS licence number 0046
	LT 071CT C M65	Chrome	1005.00	
	LT 071CT C R65	Chrome	1005.00	
STREAMJET™ XL				
	LT 071CX BN L65	Brushed Nickel	1120.00	<ul style="list-style-type: none"> • ABS 130mm single function shower • Concentric full pattern spray • Rub-clean spray diffuser • WaterMark AS 3662 WMKT 21147 • Available in 3 Star 9L/min as per WELS licence number 0046
	LT 071CX BN M65	Brushed Nickel	1120.00	
	LT 071CX BN R65	Brushed Nickel	1120.00	
	LT 071CX C L65	Chrome	1000.00	
	LT 071CX C M65	Chrome	1000.00	
	LT 071CX C R65	Chrome	1000.00	
STREAMJET™ XL TURBO PULSATOR				
	LT 071CS C L65	Chrome	1030.00	<ul style="list-style-type: none"> • ABS 130mm multi-function shower • Soft, pulsating and bubble spray functions • Rub-clean spray diffuser • WaterMark AS 3662 WMKT 21147 • Available in 3 Star 9L/min as per WELS licence number 0046
	LT 071CS C M65	Chrome	1030.00	
	LT 071CS C R65	Chrome	1030.00	
PRINCESS				
	LT 071CP C L65	Chrome	960.00	<ul style="list-style-type: none"> • ABS 83mm arched single function shower • Full pattern spray • Rub-clean spray diffuser • WaterMark AS 3662 WMKT 21147 • Available in 3 Star 9L/min as per WELS licence number 0046
	LT 071CP C M65	Chrome	960.00	
	LT 071CP C R65	Chrome	960.00	
BREEZE				
	LT 071CZ C L65	Chrome	976.00	<ul style="list-style-type: none"> • ABS 104mm arched multi-function shower • Soft, pulsating and bubble spray functions • Rub-clean spray diffuser • Available in 3 Star 9L/min as per WELS licence number 0046
	LT 071CZ C M65	Chrome	976.00	
	LT 071CZ C R65	Chrome	976.00	

Shower Seats

	Code	Finish	Without GST	Features
ACCESSIBLE SUITES				
	SS 964 BS	Brushed Stainless	560.00	<ul style="list-style-type: none"> • Seat size: 960mm x 400mm • Folding legs for added support • Assembled with UV stabilised, fade resistant High Density Polyethylene (HDPE) seat deck with self draining channels • Frame fabricated from 304 stainless steel • Maximum load 250kg • Stainless steel fixing screws supplied • Meets the requirements of AS 1428.1:2021 Design for access and mobility  
	SS 964 BSB	Brushed Stainless/Black Seat	590.00	
	SS 964 MB	Matte Black	720.00	
	SS 964 PS	Polish Supreme™	650.00	
	SS 964 WT	White	720.00	
SHOWER SEAT LEG EXTENSIONS (PR) 50MM M- 200MM				
	SS 964 BS LE	Brushed Stainless	77.00	<ul style="list-style-type: none"> • Increased leg length (max. 200mm) • Ideal for installations where floor is not level • Fabricated from 304 stainless steel • Suitable for SS 604, SS 845 & SS 964 models only 
	SS 964 PS LE	Polish Supreme™	88.00	
WHEELCHAIR TRANSFER				
	SS 964 BS WM	Brushed Stainless	475.00	<ul style="list-style-type: none"> • Seat size: 960mm x 400mm • Transfer conveniently from wheelchair • Assembled with UV stabilised, fade resistant High Density Polyethylene (HDPE) seat deck with self draining channels • Frame fabricated from 304 stainless steel • Maximum load 250kg • Stainless steel fixing screws supplied • Meets the requirements of AS 1428.1:2021 Design for access and mobility  
	SS 964 BSB WM	Brushed Stainless/Black Seat	505.00	
COVERED WALLS				
	SS 964 BS CW	Brushed Stainless	698.00	<ul style="list-style-type: none"> • Seat size: 960mm x 400mm • Floor mounted - Rear leg fastening • Assembled with UV stabilised, fade resistant High Density Polyethylene (HDPE) seat deck with self draining channels • Frame fabricated from 304 stainless steel • Maximum load 250kg • Stainless steel fixing screws supplied • Meets the requirements of AS 1428.1:2021 Design for access and mobility  
SLATTED SEAT DECK				
	SS 964 AW ME	Antimicrobial White	1150.00	<ul style="list-style-type: none"> • Seat size: 960mm x 400mm • 3 part slatted seat deck fabricated from 304 stainless steel, self draining • Frame fabricated from 304 stainless steel • Maximum load 250kg • Stainless steel fixing screws supplied • Meets the requirements of AS 1428.1:2021 Design for access and mobility  
	SS 964 BS ME	Brushed Stainless	810.00	
	SS 964 MB ME	Matte Black	1150.00	
BARIATRIC SEAT FOR AREAS NOT STRICTLY DISABLED				
	SS 965 BS	Brushed Stainless	870.00	<ul style="list-style-type: none"> • Large seat size: 960mm x 500mm large seat • Additional centre support • Folding legs for added support • Assembled with UV stabilised, fade resistant High Density Polyethylene (HDPE) seat deck with self draining channels • Frame fabricated from 304 stainless steel • Maximum load 400kg • Stainless steel fixing screws supplied  

SHOWER SEATS

Con-Serv Folding Shower Seats have been designed for users who are unable, or find it difficult to shower while standing. Seat frames feature tension grip hinges for horizontal and vertical movement, fabricated from 304 stainless steel and secured to the seat deck with concealed 316 stainless steel screws. Seat decks are UV stabilised, tamper resistant, sanitary safe and fabricated from High Density Polyethylene (HDPE) with soft, round edges and self draining channels.

	Code	Finish	Without GST	Features	
FOLDING SHOWER SEAT SUITABLE FOR CHANGING PLACES 960MM x 450MM					
	SS 945 BS	Brushed Stainless	600.00	<ul style="list-style-type: none"> • Large seat size: 960mm x 450mm • Folding legs for added support • Assembled with UV stabilised, fade resistant High Density Polyethylene (HDPE) seat deck with self draining channels • Frame fabricated from 304 stainless steel • Maximum load 250kg • Stainless steel fixing screws supplied • Complies with clause 3.13.8 Folding seat of Changing Places Design Specifications 2020  	
NEW ZEALAND STANDARDS NZS 4121:2001					
	SS 845 BS	Brushed Stainless	580.00	<ul style="list-style-type: none"> • Seat size: 800mm x 450mm • Assembled with UV stabilised, fade resistant High Density Polyethylene (HDPE) seat deck with self draining channels • Frame fabricated from 304 stainless steel • Maximum load 250kg • Stainless steel fixings screws supplied • Complies with New Zealand Standards NZS 4121:2001 	
COMPACT SHOWER SEAT FOR AREAS NOT STRICTLY DISABLED					
	SS 604 BS	Brushed Stainless	480.00	<ul style="list-style-type: none"> • Seat size: 600mm x 400mm • Assembled with UV stabilised, fade resistant High Density Polyethylene (HDPE) seat deck with self draining channels • Frame fabricated from 304 stainless steel • Maximum load 160kg • Stainless steel fixings screws supplied 	
	SS 604 PS	Polish Supreme™	555.00		
COMPACT SHOWER SEAT FOR AREAS NOT STRICTLY DISABLED					
	SS 604 BS ME	Brushed Stainless	670.00	<ul style="list-style-type: none"> • Seat size: 600mm x 400mm • 3 part slatted seat deck fabricated from 304 stainless steel, self draining • Frame fabricated from 304 stainless steel • Maximum load 160kg • Stainless steel fixings screws supplied 	
SHOWER SEAT WITH CUTOUT FOR AREAS NOT STRICTLY DISABLED					
	SS 604 BS WA	Brushed Stainless	520.00	<ul style="list-style-type: none"> • Seat size: 600mm x 400mm • Convenient access for washing • Assembled with UV stabilised, fade resistant High Density Polyethylene (HDPE) seat deck with self draining channels • Frame fabricated from 304 stainless steel • Maximum load 160kg • Stainless steel fixings screws supplied 	
SIDE LIFT SHOWER SEAT FOR AREAS NOT STRICTLY DISABLED					
	SS 645 BS	Brushed Stainless	505.00	<ul style="list-style-type: none"> • Seat size: 450mm x 600mm • Side lift option for limited wall space applications • Assembled with UV stabilised, fade resistant High Density Polyethylene (HDPE) seat deck with self draining channels • Frame fabricated from 304 stainless steel • Maximum load 160kg • Stainless steel fixing screws supplied • Patent Number 2008100882 	

Folding, Swing and Floor/Wall Grab Rails

	Code	Finish	Without GST	Features
TILTLOCK® 850MM GRAB RAIL				
	TL 850 AW LH	Antimicrobial White	665.00	<ul style="list-style-type: none"> • 850mm folding grab rail • Locks in horizontal or vertical positions • Chrome plated brass push button release, tensioning bolt and end cap • Fabricated from 32mm 304 stainless steel • Stainless steel fixings supplied • Suitable for non-compliant applications in hospitals, aged care facilities, and nursing homes • Safe working load 200kg downwards • Tested by ANTL (test report 4197.12-22.07.13)
	TL 850 AW RH	Antimicrobial White	665.00	
	TL 850 BS LH	Brushed Stainless	600.00	
	TL 850 BS RH	Brushed Stainless	600.00	
	TL 850 MB LH	Matte Black	665.00	
	TL 850 MB RH	Matte Black	665.00	
	TL 850 PS LH	Polish Supreme™	640.00	
	TL 850 PS RH	Polish Supreme™	640.00	
Drawn LH (Left Hand)				
TILTLOCK® 850MM GRAB RAIL WITH STAINLESS STEEL FIXED TOILET PAPER HOLDER				
	TL 850 AW LHS	Antimicrobial White	710.00	<ul style="list-style-type: none"> • 850mm folding grab rail • Stainless steel toilet paper holder (Factory Fitted) • Locks in horizontal or vertical positions • Chrome plated brass push button release, tensioning bolt and end cap • Fabricated from 32mm 304 stainless steel • Stainless steel fixings supplied • Suitable for non-compliant applications in hospitals, aged care facilities and nursing homes • Safe working load 200kg downwards • Tested by ANTL (test report 4197.12-22.07.13)
	TL 850 AW RHS	Antimicrobial White	710.00	
	TL 850 BS LHS	Brushed Stainless	650.00	
	TL 850 BS RHS	Brushed Stainless	650.00	
	TL 850 MB LHS	Matte Black	710.00	
	TL 850 MB RHS	Matte Black	710.00	
	TL 850 PS LHS	Polish Supreme™	690.00	
	TL 850 PS RHS	Polish Supreme™	690.00	
Drawn LH (Left Hand)				
TILTLOCK® 850MM GRAB RAIL WITH FLEXIBLE FIX TOILET PAPER HOLDER				
	TL 850 BS LHT	Brushed Stainless	645.00	<ul style="list-style-type: none"> • 850mm folding grab rail • Flexible ABS toilet paper holder • Locks in horizontal or vertical positions • Chrome plated brass push button release, tensioning bolt and end cap • Fabricated from 32mm 304 stainless steel • Stainless steel fixings supplied • Suitable for non-compliant applications in hospitals, aged care facilities and nursing homes • Safe working load 200kg downwards • Tested by ANTL (test report 4197.12-22.07.13)
	TL 850 BS RHT	Brushed Stainless	645.00	
	TL 850 PS LHT	Polish Supreme™	685.00	
	TL 850 PS RHT	Polish Supreme™	685.00	
Drawn LH (Left Hand)				
TILTLOCK® 850MM GRAB RAIL WITH STAINLESS STEEL NURSE CALL MOUNT BOX				
	TL 850 BS LHN	Brushed Stainless	685.00	<ul style="list-style-type: none"> • 850mm folding grab rail • Factory fitted stainless steel nurse call mount box • Locks in horizontal or vertical positions • Chrome plated brass push button release, tensioning bolt and end cap • Fabricated from 32mm 304 stainless steel • Stainless steel fixings supplied • Suitable for non-compliant applications in hospitals, aged care facilities and nursing homes • Safe working load 200kg downwards • Tested by ANTL (test report 4197.12-22.07.13)
	TL 850 BS RHN	Brushed Stainless	685.00	
	TL 850 PS LHN	Polish Supreme™	765.00	
	TL 850 PS RHN	Polish Supreme™	765.00	
Drawn LH (Left Hand)				

TILTLOCK® TWIN MOUNT

M8 X 75, stainless steel hexagon coach screws and 10mm wall plugs supplied with Tiltlock®



NO EXPOSED NUTS OR BOLTS

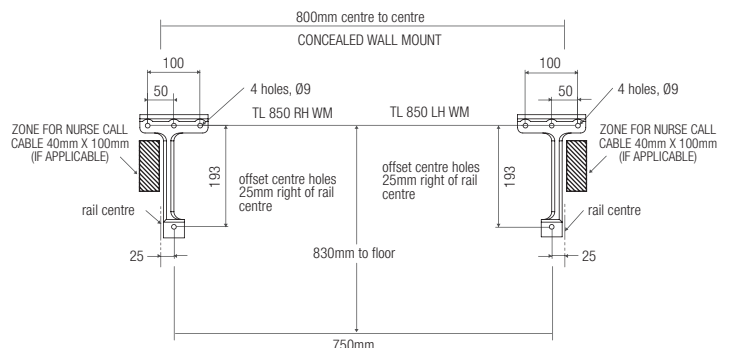

PATENT NUMBER: 2006100929

FOLDING, SWING AND FLOOR/WALL GRAB RAILS TILTLOCK®, SWINGLOCK®, FLOOR & LIFT-N-LOCK™

Con-Serv have grab rail solutions for all applications, including options for non-standard room configurations. Suited to non-accessible applications, Tiltlock®, Swinglock®, Lift'N'Lock™ and Floor/Wall Mounted grab rails are designed for functionality in difficult room layouts.

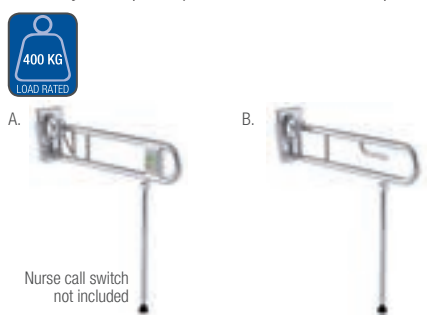
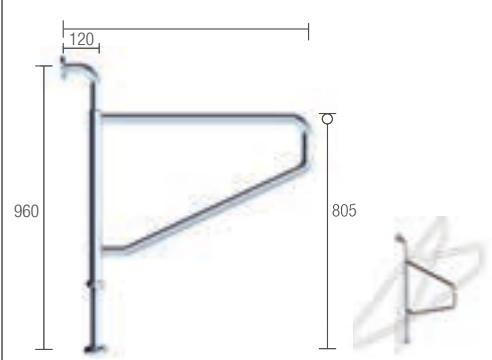
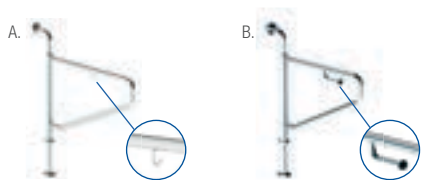
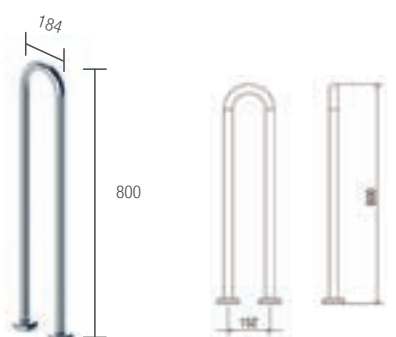
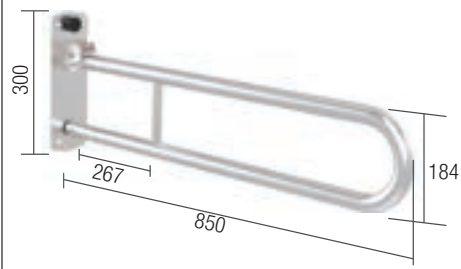
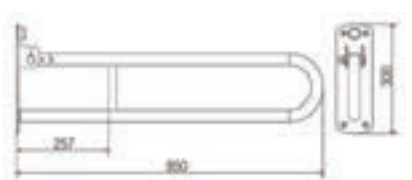
	Code	Finish	Without GST	Features	
TILTLOCK® 850MM BARIATRIC FOLDING LEG GRAB RAIL					
 <p>Drawn RH (Right Hand)</p>	TL 850 BS LHBL	Brushed Stainless	710.00	<ul style="list-style-type: none"> 850mm folding grab rail with folding leg Reinforced for bariatric applications, maximum vertical load 400kg Fabricated from 32mm 304 stainless steel Locks in horizontal or vertical positions Chrome plated brass push-button release, base housing, and concealed "T" mount bracket Stainless steel fixings supplied Tested by ANTL (test report 4699.11-12/12/2017) 	
	TL 850 BS RHBL	Brushed Stainless	710.00		
	WITH NURSE CALL MOUNT BOX (A)				
	TL 850 BS LHBN*	Brushed Stainless	795.00		
	TL 850 BS RHBN*	Brushed Stainless	795.00		
	WITH STAINLESS STEEL ROLL HOLDER (B)				
	TL 850 BS LHBS*	Brushed Stainless	760.00		
	TL 850 BS RHBS*	Brushed Stainless	760.00		
	 <p>400 KG LOAD RATED</p> <p>Nurse call switch not included</p>				
	*Allow 12 weeks for production				
SWINGLOCK® 850MM SIDE ASSIST RAIL					
 <p>Dimensions: 120, 960, 805</p>	SL 850 BS	Brushed Stainless	340.00	<ul style="list-style-type: none"> 850mm side swing grab rail Fabricated from 32mm 304 stainless steel 78mm pre-formed Clam® Flange Stainless steel fixings supplied Complies with the general requirements for applications in hospitals, homes for the elderly and nursing homes 	
	WITH NURSE CALL HOOK (A)				
	SL 850 BS H*	Brushed Stainless	370.00		
	WITH TOILET PAPER HOLDER (B)				
	SL 850 BS S*	Brushed Stainless	390.00		
					
*Allow 12 weeks for production					
FLOOR/WALL MOUNTED 800MM GRAB RAIL					
 <p>Dimensions: 184, 800</p>	CF 818 BS	Brushed Stainless	120.00	<ul style="list-style-type: none"> Free standing, floor or wall mounted grab rail Fabricated from 32mm 304 stainless steel 78mm pre-formed domed Clam® Flange Stainless steel fixings supplied 	
LIFT-N-LOCK™ 850MM FOLDING GRAB RAIL					
 <p>Dimensions: 300, 267, 850, 184</p> <p>Drawn LH (Left Hand)</p>	LL 850 BS	Brushed Stainless	390.00	<ul style="list-style-type: none"> 850mm folding grab rail Locks in the vertical position Fabricated from 32mm 304 stainless steel Suitable for non-compliant applications Stainless steel fixings supplied 	
					

Spare Parts and Accessories

	Code	Finish	Without GST	Features	
GRAB RAIL FLEXIBLE TOILET PAPER HOLDER					
	TR 031 BLC	Black/Chrome	45.00	<ul style="list-style-type: none"> • Fastens to 32mm grab rail • ABS construction • Chrome toilet paper holder and lock nut • Easy to position where needed • Simple to clean • Retro Fitted 	
	TR 031 GYC	Grey/Chrome	45.00		
	TR 031 WTC	White/Chrome	45.00		
GRAB RAIL STAINLESS STEEL TOILET PAPER HOLDER					
 <p>Stainless Steel</p>	TR 031 BS S	Brushed Stainless	90.00	<ul style="list-style-type: none"> • Suits 32mm grab rail • Stainless steel construction • Factory fitted 	
	TR 031 PS S	Polish Supreme™	95.00		
HYGIENIC SEAL® WALL MOUNT PLATE					
	HS 032 B MP	Brass	13.00	<ul style="list-style-type: none"> • Mounting plate for Hygienic Seal® grab rails • Enlarged fixing points for fastening adjustment • Brass construction • Stainless steel fixings supplied 	
HYGIENIC SEAL® STAND OFF PLATE					
	HS 032 PS SP	Polish Supreme™	13.00	<ul style="list-style-type: none"> • For installation of Hygienic Seal® grab rails when fixing point extends past tiled surface • Fabricated from 304 stainless steel • Polish Supreme™ finish 	
SHOWER SEAT WALL MOUNT PLATE					
	HS 032 BS BM	Brushed Stainless	27.00	<ul style="list-style-type: none"> • Mount Plates allow for removal and re-fitting of shower seats in accessible compartments • Stainless steel construction • 50mm x 25mm • Stainless steel fixing screws supplied 	
HYGIENIC SEAL® FLANGE COVER					
	HS 032 AW FC	Antimicrobial White	16.00	<ul style="list-style-type: none"> • 50mm Hygienic Seal® flange cover • Brass construction • Chrome plated finish 	
	HS 032 BS FC	Brushed Stainless	18.00		
	HS 032 C FC	Chrome	14.00		
	HS 032 MB FC	Matte Black	18.00		
HYGIENIC SEAL® BLANK END FLANGE					
	HS 032 C BF	Chrome	20.00	<ul style="list-style-type: none"> • Cover for Hygienic Seal® wall mount plates once grab rail has been removed • Tamper resistant • Brass construction • Chrome plated finish 	
	HS 032 MB BF	Matte Black	26.00		

SPARE PARTS AND ACCESSORIES

MOUNTING SYSTEMS

Con-Serv has a range of accessories and mounting options suitable for 32mm grab rails. Accessories are available as Factory Fitted (must be installed by Con-Serv) or Retro Fitted (user installed). Mounting systems are compatible exclusively with Hygienic Seal® flanges.

	Code	Finish	Without GST	Features
HYGIENIC SEAL® SINGLE SIDED FIXING SYSTEM				
	SUITS 10MM - 14MM PARTITIONS			<ul style="list-style-type: none"> For installations requiring a grab rail fastened to a partition Suitable for partitions 10mm - 34mm
	HS 032 C BE10	Chrome	54.00	
	SUITS 15MM - 19MM PARTITIONS			
	HS 032 C BE15	Chrome	55.00	SINGLE SIDED KITS INCLUDE: <ul style="list-style-type: none"> 2 x HS 032 B MP wall mount plates 2 x HS 032 C BF blank end flanges 4 x Internal thread tubes 8 x M5 x 10mm CSK 304 screws
SUITS 30MM - 34MM PARTITIONS				
	HS 032 C BE30	Chrome	56.00	
HYGIENIC SEAL® BACK TO BACK FIXING SYSTEM				
	SUITS 10MM - 14MM PARTITIONS			<ul style="list-style-type: none"> For installations requiring back to back fastening of two (2) grab rails separated by a partition Suitable for partitions 10mm - 34mm
	HS 032 B BB10	Chrome	11.00	
	SUITS 15MM - 19MM PARTITIONS			
	HS 032 B BB15	Chrome	12.00	BACK TO BACK KITS INCLUDE: <ul style="list-style-type: none"> 4 x Internal thread tubes 8 x M5 x 10mm CSK 304 screws
SUITS 30MM - 34MM PARTITIONS				
	HS 032 B BB30	Chrome	13.00	
HIDEAWAY™ MOUNTING SYSTEM FOR GRAB RAILS				
	HYGIENIC SEAL® MOUNTING PLATE (A)			<ul style="list-style-type: none"> Hygienic Seal® Blank End Flanges (B) are designed to conceal the grab rail wall mount plate (A) in situations where the grab rail needs to be removed To install, unscrew the Hygienic Seal® flange, and cover with the existing wall plate (A) with the blank end flange (B) To ensure a tamper resistant installation, tighten the tamper resistant grub screw with the hex key supplied Brass construction Please note, mounting plates are included with our Hygienic Seal® Grab Rail or Backrest
	HS 032 B MP	Brass	13.00	
	BLANK END FLANGE (B)			
	HS 032 C BF	Chrome	20.00	
	HS 032 MB BF	Matte Black	26.00	
	RETROFIT BACKREST KIT (SET OF 4)			
	HS 432 C BF	Chrome	132.00	
	HS 432 MB BF	Matte Black	156.00	
HIDEAWAY™ MOUNTING SYSTEM FOR SHOWER SEATS				
	SHOWER SEAT MOUNTING PLATE (A)			<ul style="list-style-type: none"> Compatible with Con-Serv Folding Shower Seats, Hygienic Seal® Blank End Flanges conceal the shower seat mount plates in situations where the seat needs to be removed To install, simply remove the shower seat fixing and cover with the existing wall plate with the blank end flange To ensure a tamper resistant installation, tighten the tamper resistant grub screw with the hex key supplied Brass construction Please note, mounting plates are not included with our Folding Shower Seat
	HS 032 BS BM	Brushed Stainless	27.00	
	BLANK END FLANGE (B)			
	HS 032 C BF	Chrome	20.00	
	HS 032 MB BF	Matte Black	26.00	
	RETROFIT SHOWER SEAT KIT (SET OF 4)			
	HS 432 C SF	Chrome	188.00	
	HS 432 MB SF	Matte Black	212.00	

*Backrest not included.

*Shower and Shower Seat are not included.

SPARE PARTS AND ACCESSORIES

HOSE RESTRICTOR, SLIDERS AND ACCESSORIES

Con-Serv has a range of shower sliders and accessories suitable for 32mm grab rails. Sliders and accessories are available as Factory Fitted (must be installed by Con-Serv) or Retro Fitted (user installed).

	Code	Finish	Without GST	With GST	Features
HOSE RESTRICTOR BRACKET					
	HR 015 BN	Brushed Nickel	65.00	71.50	<ul style="list-style-type: none"> • Wall mounted hose restrictor • Brass construction • Ideal for accessible applications with handheld showers in close proximity to the WC. • Dual screw wall mount plate • Stainless steel fixings supplied
	HR 015 C	Chrome	50.00	55.00	
	HR 015 MB	Matte Black	65.00	71.50	
GRAB RAIL SOAP DISH HOLDER					
	SD 032 BLC	Black/Chrome	45.00	Exempt	<ul style="list-style-type: none"> • Fastens to 32mm grab rail • ABS construction • Chrome plated lock nut • Simple to clean • Retro fitted
	SD 032 GYC	Grey/Chrome	45.00	Exempt	
	SD 032 WTC	White/Chrome	45.00	Exempt	
GRAB RAIL GLIDE SLIDE HANDSET CRADLE					
	HC 024 AW	Antimicrobial White	42.00	Exempt	<ul style="list-style-type: none"> • Clicklock™ cradle mechanism • Fastens to 32mm grab rail • ABS construction • Chrome handset cradle and lock nut • Simple to clean • Retro fitted
	HC 024 BLC	Black/Chrome	42.00	Exempt	
	HC 024 GYC	Grey/Chrome	42.00	Exempt	
	HC 024 WTC	White/Chrome	40.00	Exempt	
BRASS 32MM FRICTION SLIDE CRADLE					
	HC 932 BN	Brushed Nickel	145.00	Exempt	<ul style="list-style-type: none"> • Suits 32mm grab rail • Pivoting cradle adjustment for handset • Smooth slide action • Self locking • Brass construction • Factory fitted <p style="text-align: right;">ONLY COMPATIBLE WITH CON-SERV GRAB RAILS</p>
	HC 932 C	Chrome	110.00	Exempt	
	HC 932 MB	Matte Black	145.00	Exempt	
FACTORY FITTED					
PUSH-PULLME® SHOWER POSITIONING CRADLE WITH ROD					
	PM 932 C	Chrome	142.00	Exempt	<ul style="list-style-type: none"> • Suits 32mm grab rail • Pivoting cradle adjustment for handset • Height adjustment rod for seated users • Smooth slide action • Self locking • Brass construction • Chrome plated finish • Factory fitted • Complies with AS 1428.1:2021 <p style="text-align: right;">ONLY COMPATIBLE WITH CON-SERV GRAB RAILS</p>
FACTORY FITTED					

SPARE PARTS AND ACCESSORIES

RAILS WITH SLIDERS

Con-Serv has a range of shower sliders and accessories suitable for 32mm grab rails. Sliders and accessories are available as Factory Fitted (must be installed by Con-Serv) or Retro Fitted (user installed).

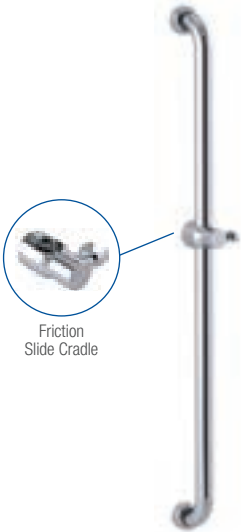
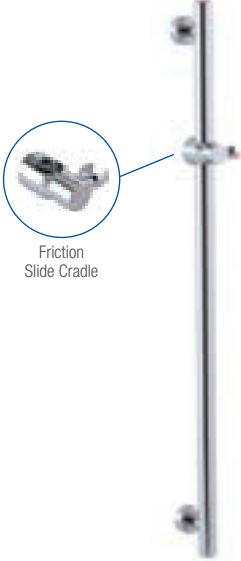
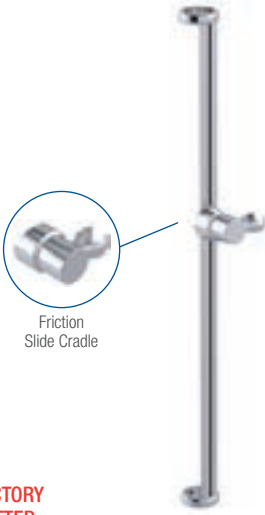
	Code	Finish	Without GST	Features
HYGIENIC SEAL® 900MM GRAB RAIL WITH FRICTION SLIDE CRADLE				
 <p>Friction Slide Cradle</p>	HF 932 BS	Brushed Stainless	225.00	<ul style="list-style-type: none"> • 900mm, centre to centre • 32mm grab rail • Brass Friction Slide Cradle • Fabricated from 304 stainless steel • Assembled with Hygienic Seal® 50mm brass screw on flange covers with Biomaster Thermoplastic Elastomer (TPE) fitted seals • Stainless steel fixing screws supplied • Meets the requirements of AS 1428.1:2021 Design for access and mobility
	HF 932 C	Chrome	205.00	
	HF 932 MB	Matte Black	280.00	
LINEAR 900MM GRAB RAIL WITH FRICTION SLIDE CRADLE				
 <p>Friction Slide Cradle</p>	LF 932 BS	Brushed Stainless	260.00	<ul style="list-style-type: none"> • 900mm, centre to centre • 32mm Linear grab rail • Brass Friction Slide Cradle • Fabricated from 304 stainless steel • Assembled with Hygienic Seal® 50mm brass screw on flange covers with Biomaster Thermoplastic Elastomer (TPE) fitted seals • Stainless steel fixing screws supplied • Meets the requirements of AS 1428.1:2021 Design for access and mobility
	LF 932 C	Chrome	295.00	
	LF 932 MB	Matte Black	375.00	
PREMIUM 700MM FRICTION SLIDE TRACK CRADLE & COLLARS				
 <p>Friction Slide Cradle</p>	SR 700 C	Chrome	150.00	<ul style="list-style-type: none"> • Brass 700mm low profile track • Suits 32mm grab rails • Recommended for persons with weakened wrists, arthritic or grip problems • Recommended for persons with weakened wrists, arthritic or grip problems • Brass friction slide cradle for handset support & height adjustment • Factory fitted <p>ONLY COMPATIBLE WITH CON-SERV GRAB RAILS</p>
	SR 700 MB	Matte Black	195.00	
	SR 700 WTC	White/Chrome	160.00	
FACTORY FITTED				

SPARE PARTS AND ACCESSORIES - SHOWER KITS

32MM GLIDE SLIDE

- ABS 32mm Glide Slide handset cradle
- DR brass wall outlet elbow
- DR brass 9L/min flow Interchange® spigot
- Licenced dual check/non-return valve
- 57mm solid brass round flat flange
- PVC 1500mm hose



Model	Code	Finish	GST Exempt	Features
STREAMJET™				
	HS 01806J C	Chrome	212.00	<ul style="list-style-type: none"> • ABS 100mm single function shower • Concentric full pattern spray • Rub-clean spray diffuser • WaterMark AS 3662 WMKT 21147 • Available in 3 Star 9L/min and 4 Star 6.5L/min as per WELS licence number 0046
	HS 01806J C/6.5	Chrome	212.00	
	HS 01806J WTC	White/Chrome	203.00	
	HS 01806J WTC/6.5	White/Chrome	203.00	
STREAMJET™ TURBO PULSATOR				
	HS 01806T C	Chrome	242.00	<ul style="list-style-type: none"> • ABS 100mm multi-function shower • Soft, pulsating and bubble spray functions • Rub-clean spray diffuser • WaterMark AS 3662 WMKT 21147 • Available in 3 Star 9L/min as per WELS licence number 0046
STREAMJET™ XL				
	HS 01806X C	Chrome	237.00	<ul style="list-style-type: none"> • ABS 130mm single function shower • Concentric full pattern spray • Rub-clean spray diffuser • WaterMark AS 3662 WMKT 21147 • Available in 3 Star 9L/min as per WELS licence number 0046
STREAMJET™ XL TURBO PULSATOR				
	HS 01806S C	Chrome	267.00	<ul style="list-style-type: none"> • ABS 130mm multi-function shower • Soft, pulsating and bubble spray functions • Rub-clean spray diffuser • WaterMark AS 3662 WMKT 21147 • Available in 3 Star 9L/min as per WELS licence number 0046
HOSCARE®				
	HS 01806 C	Chrome	182.00	<ul style="list-style-type: none"> • ABS 100mm single function shower with Biomaster antimicrobial additive • Concentric full pattern spray • Rub-clean spray diffuser • WaterMark AS 3662 WMKT 21147 • Available in 3 Star 9L/min and 4 Star 6.5L/min as per WELS licence number 0046
	HS 01806 C/6.5	Chrome	182.00	
	HS 01806 AW	Antimicrobial White	188.00	
	HS 01806 AW/6.5	Antimicrobial White	188.00	
PRINCESS				
	HS 01806P C	Chrome	197.00	<ul style="list-style-type: none"> • ABS 83mm arched single function shower • Full pattern spray • Rub-clean spray diffuser • WaterMark AS 3662 WMKT 21147 • Available in 3 Star 9L/min as per WELS licence number 0046















Model shown: HS 01806T C

SPARE PARTS AND ACCESSORIES - SHOWER KITS

32MM GLIDE SLIDE & HOSE RESTRICTOR BRACKET

- ABS 32mm Glide Slide handset cradle
- Hose Restrictor Bracket
- DR brass wall outlet elbow
- DR brass 9L/min flow Interchange® spigot
- Licenced dual check/non-return valve
- 57mm solid brass round flat flange
- PVC 1500mm hose



Model	Code	Finish	GST Exempt	Features
STREAMJET™				
	HS 01810J C	Chrome	262.00	<ul style="list-style-type: none"> • ABS 100mm single function shower • Concentric full pattern spray • Rub-clean spray diffuser • WaterMark AS 3662 WMKT 21147 • Available in 3 Star 9L/min and 4 Star 6.5L/min as per WELS licence number 0046 
	HS 01810J C/6.5	Chrome	262.00	
	HS 01810J WTC	White/Chrome	253.00	
	HS 01810J WTC/6.5	White/Chrome	253.00	
STREAMJET™ TURBO PULSATOR				
	HS 01810T C	Chrome	292.00	<ul style="list-style-type: none"> • ABS 100mm multi-function shower • Soft, pulsating and bubble spray functions • Rub-clean spray diffuser • WaterMark AS 3662 WMKT 21147 • Available in 3 Star 9L/min as per WELS licence number 0046 
STREAMJET™ XL				
	HS 01810X C	Chrome	287.00	<ul style="list-style-type: none"> • ABS 130mm single function shower • Concentric full pattern spray • Rub-clean spray diffuser • WaterMark AS 3662 WMKT 21147 • Available in 3 Star 9L/min as per WELS licence number 0046 
STREAMJET™ XL TURBO PULSATOR				
	HS 01810S C	Chrome	317.00	<ul style="list-style-type: none"> • ABS 130mm multi-function shower • Soft, pulsating and bubble spray functions • Rub-clean spray diffuser • WaterMark AS 3662 WMKT 21147 • Available in 3 Star 9L/min as per WELS licence number 0046 
HOSCARE®				
	HS 01810 C	Chrome	232.00	<ul style="list-style-type: none"> • ABS 100mm single function shower with Biomaster antimicrobial additive • Concentric full pattern spray • Rub-clean spray diffuser • WaterMark AS 3662 WMKT 21147 • Available in 3 Star 9L/min and 4 Star 6.5L/min as per WELS licence number 0046 
	HS 01810 C/6.5	Chrome	232.00	
PRINCESS				
	HS 01810P C	Chrome	247.00	<ul style="list-style-type: none"> • ABS 83mm arched single function shower • Full pattern spray • Rub-clean spray diffuser • WaterMark AS 3662 WMKT 21147 • Available in 3 Star 9L/min as per WELS licence number 0046 



Model shown: HS 01810T C

SPARE PARTS AND ACCESSORIES - SHOWER KITS

32MM FRICTION SLIDER

- 32mm Friction Slide handset cradle
- DR brass wall outlet elbow
- DR brass 9L/min flow Interchange® spigot
- Licenced dual check/non-return valve
- 57mm solid brass round flat flange
- PVC 1500mm hose



WaterMark
ASINZS 3662
WMKT 21147

GRAB RAIL NOT INCLUDED



FRICTION SLIDE CRADLE

ONLY COMPATIBLE WITH CON-SERV GRAB RAILS



Model	Code	Finish	GST Exempt	Features	
STREAMJET™					
	HS 01804J BN	Brushed Nickel	407.00	<ul style="list-style-type: none"> • ABS 100mm single function shower • Concentric full pattern spray • Rub-clean spray diffuser • WaterMark AS 3662 WMKT 21147 • Available in 3 Star 9L/min and 4 Star 6.5L/min as per WELS licence number 0046 	
	HS 01804J BN/6.5	Brushed Nickel	407.00		
	HS 01804J C	Chrome	280.00		
	HS 01804J C/6.5	Chrome	280.00		
	HS 01804J MB	Matte Black	367.00		
	HS 01804J MB/6.5	Matte Black	367.00		
STREAMJET™ TURBO PULSATOR					
	HS 01804T C	Chrome	310.00	<ul style="list-style-type: none"> • ABS 100mm multi-function shower • Soft, pulsating and bubble spray functions • Rub-clean spray diffuser • WaterMark AS 3662 WMKT 21147 • Available in 3 Star 9L/min as per WELS licence number 0046 	
STREAMJET™ XL					
	HS 01804X BN	Brushed Nickel	442.00	<ul style="list-style-type: none"> • ABS 130mm single function shower • Concentric full pattern spray • Rub-clean spray diffuser • WaterMark AS 3662 WMKT 21147 • Available in 3 Star 9L/min as per WELS licence number 0046 	
	HS 01804X C	Chrome	305.00		
	HS 01804X MB	Matte Black	402.00		
STREAMJET™ XL TURBO PULSATOR					
	HS 01804S C	Chrome	335.00	<ul style="list-style-type: none"> • ABS 130mm multi-function shower • Soft, pulsating and bubble spray functions • Rub-clean spray diffuser • WaterMark AS 3662 WMKT 21147 • Available in 3 Star 9L/min as per WELS licence number 0046 	
HOSCARE®					
	HS 01804 C	Chrome	250.00	<ul style="list-style-type: none"> • ABS 100mm single function shower with Biomaster antimicrobial additive • Concentric full pattern spray • Rub-clean spray diffuser • WaterMark AS 3662 WMKT 21147 • Available in 3 Star 9L/min and 4 Star 6.5L/min as per WELS licence number 0046 	
	HS 01804 C/6.5	Chrome	250.00		
PRINCESS					
	HS 01804P C	Chrome	265.00	<ul style="list-style-type: none"> • ABS 83mm arched single function shower • Full pattern spray • Rub-clean spray diffuser • WaterMark AS 3662 WMKT 21147 • Available in 3 Star 9L/min as per WELS licence number 0046 	











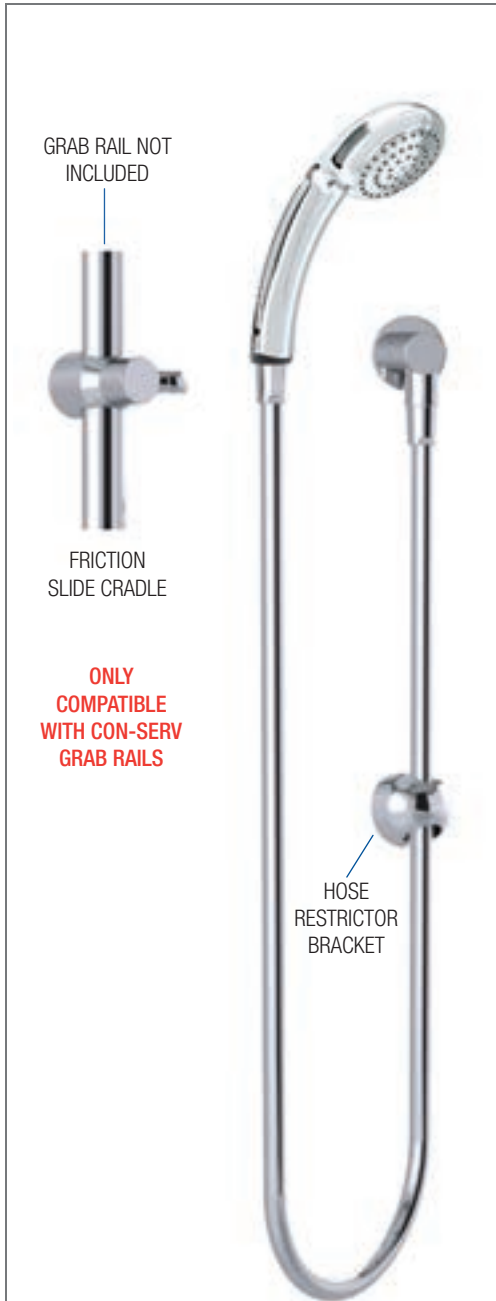



Model shown: HS 01804P C

SPARE PARTS AND ACCESSORIES - SHOWER KITS

32MM FRICTION SLIDER & HOSE RESTRICTOR BRACKET

- 32mm Friction Slide handset cradle
- Hose RestriCTOR Bracket
- DR brass wall outlet elbow
- DR brass 9L/min flow Interchange® spigot
- Licenced dual check/non-return valve
- 57mm solid brass round flat flange
- PVC 1500mm hose



Model	Code	Finish	GST Exempt	Features	
STREAMJET™					
	HS 01808J BN	Brushed Nickel	472.00	<ul style="list-style-type: none"> • ABS 100mm single function shower • Concentric full pattern spray • Rub-clean spray diffuser • WaterMark AS 3662 WMKT 21147 • Available in 3 Star 9L/min and 4 Star 6.5L/min as per WELS licence number 0046 	
	HS 01808J BN/6.5	Brushed Nickel	472.00		
	HS 01808J C	Chrome	330.00		
	HS 01808J C/6.5	Chrome	330.00		
	HS 01808J MB	Matte Black	432.00		
	HS 01808J MB/6.5	Matte Black	432.00		
STREAMJET™ TURBO PULSATOR					
	HS 01808T C	Chrome	360.00	<ul style="list-style-type: none"> • ABS 100mm multi-function shower • Soft, pulsating and bubble spray functions • Rub-clean spray diffuser • WaterMark AS 3662 WMKT 21147 • Available in 3 Star 9L/min as per WELS licence number 0046 	
STREAMJET™ XL					
	HS 01808X BN	Brushed Nickel	507.00	<ul style="list-style-type: none"> • ABS 130mm single function shower • Concentric full pattern spray • Rub-clean spray diffuser • WaterMark AS 3662 WMKT 21147 • Available in 3 Star 9L/min as per WELS licence number 0046 	
	HS 01808X C	Chrome	355.00		
	HS 01808X MB	Matte Black	467.00		
STREAMJET™ XL TURBO PULSATOR					
	HS 01808S C	Chrome	385.00	<ul style="list-style-type: none"> • ABS 130mm multi-function shower • Soft, pulsating and bubble spray functions • Rub-clean spray diffuser • WaterMark AS 3662 WMKT 21147 • Available in 3 Star 9L/min as per WELS licence number 0046 	
HOSCARE®					
	HS 01808 C	Chrome	300.00	<ul style="list-style-type: none"> • ABS 100mm single function shower with Biomaster antimicrobial additive • Concentric full pattern spray • Rub-clean spray diffuser • WaterMark AS 3662 WMKT 21147 • Available in 3 Star 9L/min and 4 Star 6.5L/min as per WELS licence number 0046 	
	HS 01808 C/6.5	Chrome	300.00		
PRINCESS					
	HS 01808P C	Chrome	315.00	<ul style="list-style-type: none"> • ABS 83mm arched single function shower • Full pattern spray • Rub-clean spray diffuser • WaterMark AS 3662 WMKT 21147 • Available in 3 Star 9L/min as per WELS licence number 0046 	



Model shown: HS 01808P C

SPARE PARTS AND ACCESSORIES - SHOWER KITS

32MM PUSH-PULLME® CRADLE WITH ROD







- 32mm Push-PullMe® cradle with rod
- DR brass wall outlet elbow
- DR brass 9L/min flow Interchange® spigot
- Licenced dual check/non-return valve
- 57mm solid brass round flat flange
- PVC 1500mm hose



GRAB RAIL NOT INCLUDED

PUSH-PULLME®
CRADLE
WITH ROD

**KIT ONLY
COMPATIBLE
WITH CON-SERV
GRAB RAILS**

Model	Code	Finish	GST Exempt	Features
STREAMJET™				
	ID 01804J C	Chrome	312.00	<ul style="list-style-type: none"> • ABS 100mm single function shower • Concentric full pattern spray • Rub-clean spray diffuser • WaterMark AS 3662 WMKT 21147 • Available in 3 Star 9L/min and 4 Star 6.5L/min as per WELS licence number 0046 
	ID 01804J C/6.5	Chrome	312.00	
STREAMJET™ TURBO PULSATOR				
	ID 01804T C	Chrome	342.00	<ul style="list-style-type: none"> • ABS 100mm multi-function shower • Soft, pulsating and bubble spray functions • Rub-clean spray diffuser • WaterMark AS 3662 WMKT 21147 • Available in 3 Star 9L/min as per WELS licence number 0046 
STREAMJET™ XL				
	ID 01804X C	Chrome	337.00	<ul style="list-style-type: none"> • ABS 130mm single function shower • Concentric full pattern spray • Rub-clean spray diffuser • WaterMark AS 3662 WMKT 21147 • Available in 3 Star 9L/min as per WELS licence number 0046 
STREAMJET™ XL TURBO PULSATOR				
	ID 01804S C	Chrome	367.00	<ul style="list-style-type: none"> • ABS 130mm multi-function shower • Soft, pulsating and bubble spray functions • Rub-clean spray diffuser • WaterMark AS 3662 WMKT 21147 • Available in 3 Star 9L/min as per WELS licence number 0046 
HOSCARE®				
	ID 01804 C	Chrome	282.00	<ul style="list-style-type: none"> • ABS 100mm single function shower with Biomaster antimicrobial additive • Concentric full pattern spray • Rub-clean spray diffuser • WaterMark AS 3662 WMKT 21147 • Available in 3 Star 9L/min and 4 Star 6.5L/min as per WELS licence number 0046 
	ID 01804 C/6.5	Chrome	282.00	
PRINCESS				
	ID 01804P C	Chrome	297.00	<ul style="list-style-type: none"> • ABS 83mm arched single function shower • Full pattern spray • Rub-clean spray diffuser • WaterMark AS 3662 WMKT 21147 • Available in 3 Star 9L/min as per WELS licence number 0046 



Model shown: ID 01804P C

SPARE PARTS AND ACCESSORIES - SHOWER KITS





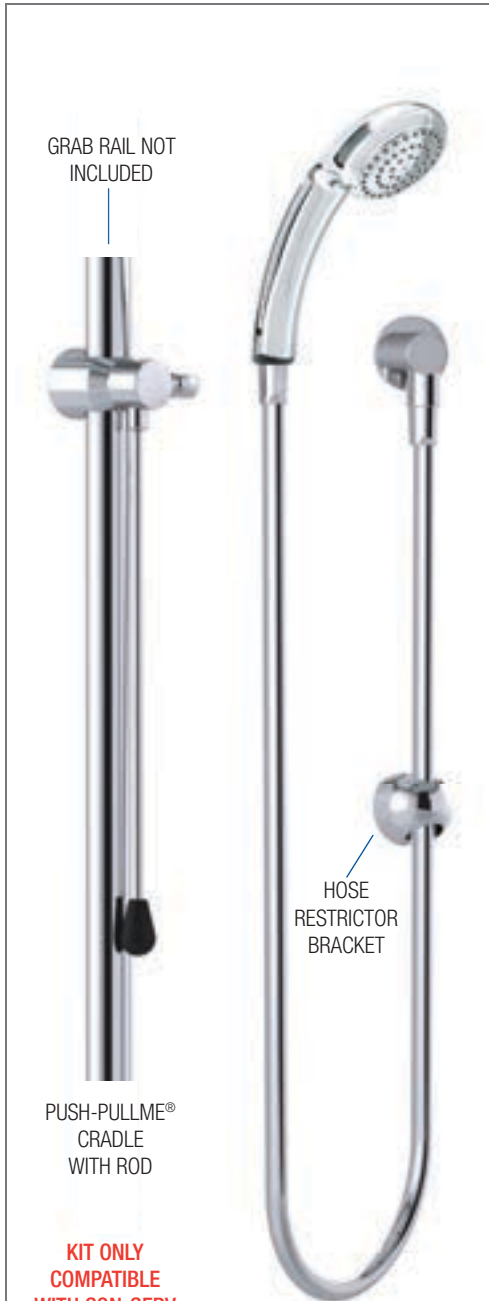







32MM PUSH-PULLME® & HOSE RESTRICTOR BRACKET

- 32mm Push-PullMe® cradle with rod
- Hose Restrictor Bracket
- DR brass wall outlet elbow
- DR brass 9L/min flow Interchange® spigot
- Licenced dual check/non-return valve
- 57mm solid brass round flat flange
- PVC 1500mm hose



PUSH-PULLME®
CRADLE
WITH ROD

**KIT ONLY
COMPATIBLE
WITH CON-SERV
GRAB RAILS**

Model	Code	Finish	GST Exempt	Features
STREAMJET™				
	ID 01808J C	Chrome	362.00	<ul style="list-style-type: none"> • ABS 100mm single function shower • Concentric full pattern spray • Rub-clean spray diffuser • WaterMark AS 3662 WMKT 21147 • Available in 3 Star 9L/min and 4 Star 6.5L/min as per WELS licence number 0046 
	ID 01808J C/6.5	Chrome	362.00	
STREAMJET™ TURBO PULSATOR				
	ID 01808T C	Chrome	392.00	<ul style="list-style-type: none"> • ABS 100mm multi-function shower • Soft, pulsating and bubble spray functions • Rub-clean spray diffuser • WaterMark AS 3662 WMKT 21147 • Available in 3 Star 9L/min as per WELS licence number 0046 
STREAMJET™ XL				
	ID 01808X C	Chrome	387.00	<ul style="list-style-type: none"> • ABS 130mm single function shower • Concentric full pattern spray • Rub-clean spray diffuser • WaterMark AS 3662 WMKT 21147 • Available in 3 Star 9L/min as per WELS licence number 0046 
STREAMJET™ XL TURBO PULSATOR				
	ID 01808S C	Chrome	417.00	<ul style="list-style-type: none"> • ABS 130mm multi-function shower • Soft, pulsating and bubble spray functions • Rub-clean spray diffuser • WaterMark AS 3662 WMKT 21147 • Available in 3 Star 9L/min as per WELS licence number 0046 
HOSCARE®				
	ID 01808 C	Chrome	332.00	<ul style="list-style-type: none"> • ABS 100mm single function shower with Biomaster antimicrobial additive • Concentric full pattern spray • Rub-clean spray diffuser • WaterMark AS 3662 WMKT 21147 • Available in 3 Star 9L/min and 4 Star 6.5L/min as per WELS licence number 0046 
	ID 01808 C/6.5	Chrome	332.00	
				
PRINCESS				
	ID 01808P C	Chrome	347.00	<ul style="list-style-type: none"> • ABS 83mm arched single function shower • Full pattern spray • Rub-clean spray diffuser • WaterMark AS 3662 WMKT 21147 • Available in 3 Star 9L/min as per WELS licence number 0046 



Model shown: ID 01808P C



AS 1428.1:2021 Combination Kits



AS 1428.1:2021 - SECTION 12 ACCESSIBLE SANITARY FACILITIES

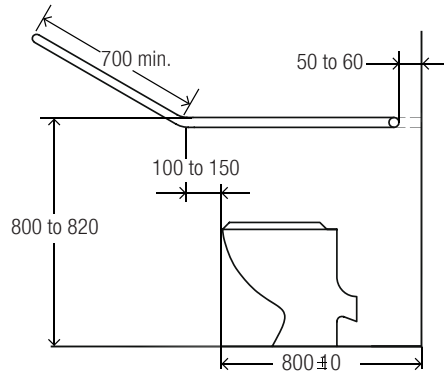

Con-Serv have developed a collection of AS 1428.1:2021 Kits that meet the needs for Accessible Sanitary Facilities, Accessible Shower Recess, Accessible Combined Sanitary Facilities (Section 12) and Ambulant Accessible Sanitary Compartments (Section 13).

Code	Finish	Without GST	Features
ACCESSIBLE SANITARY FACILITIES COMBINATION SET: OPTION A FOR USE WITH EXPOSED CISTERNS			
CLAM® FLANGE			
AC 877 BS CF LH	Brushed Stainless	627.00	<ul style="list-style-type: none"> Grab rails meet the requirements of AS 1428.1:2021 Design for access and mobility, when installed correction TPE seals with Biomaster antimicrobial additive All dimensions Ø to Ø distances Wall clearance 55mm Stainless steel fixing screws supplied
AC 877 BS CF RH	Brushed Stainless	627.00	
AC 877 PS CF LH	Polish Supreme™	692.00	
AC 877 PS CF RH	Polish Supreme™	692.00	
HYGIENIC SEAL®			
AC 877 BS HS LH	Brushed Stainless	715.00	COMBINATION SET INCLUDES: A. 870mm x 700mm grab rail B. Toilet paper holder C. Wall mount backrest D. 300mm grab rail   Other Colours P.O.A.
AC 877 BS HS RH	Brushed Stainless	715.00	
AC 877 MB HS LH	Matte Black	965.00	
AC 877 MB HS RH	Matte Black	965.00	
AC 877 PS HS LH	Polish Supreme™	761.00	
AC 877 PS HS RH	Polish Supreme™	761.00	
LINEAR			
AC 877 BS LR LH	Brushed Stainless	845.00	 <p>Top of grab rail 800mm to 820mm above the finished floor. Drawn RH (Right Hand)</p>
AC 877 BS LR RH	Brushed Stainless	845.00	
AC 877 MB LR LH	Matte Black	1080.00	
AC 877 MB LR RH	Matte Black	1080.00	
AC 877 PS LR LH	Polish Supreme™	908.00	
AC 877 PS LR RH	Polish Supreme™	908.00	

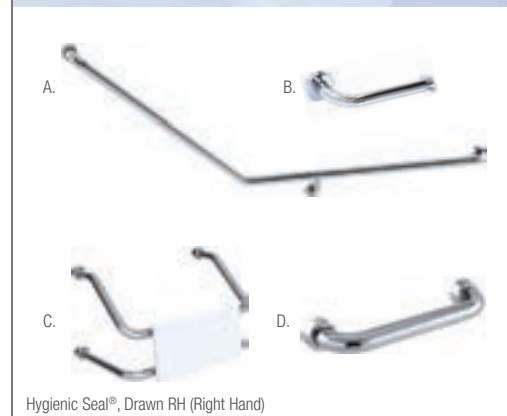

AS 1428.1:2021 Updates

The AS 1428.1 is a building standard for Design for access and mobility prepared by the Australian Standards Committee. In June, 2021 a revised Standard was released. As a specialist in the manufacture and supply of healthcare bathroom fittings, we have summarised relevant updates where Con-Serv have a solution to assist in meeting the new requirements.

Backrest: Section 12.2.4 (g)

In the revised standard, section 12.2.4 (g) states "The backrest shall – in an accessible sole-occupancy unit, be capable of being removed and refitted."

This will apply to any accessible WC in a residential type setting such as a Class B or a 1B group home, boarding houses, hotels, motels or a Class 9C Aged Care facility that require an accessible sole occupancy unit.

To fulfil this requirement, Con-Serv has developed the Hideaway™ Mounting System allowing for our backrests to be removed, stored, and then re-installed when required.

The Hideaway™ Mounting System comprises of Blank End Flanges that utilise the same wall mount plates used to install Hygienic Seal® grab rails. The installer simply removes the grab rail, leaving the wall mount plate in place, and covering with the blank end flange until it's needed again. Visit Hideaway™ Mounting System for more information.

Showers: Section 12.5.1

The previous shower connection measurement has now been changed to a connection zone. The hose connection is permitted within a larger zone measuring 700mm to 1100mm above the finished floor level and 100mm to 800mm from the corner of the wall ensuring the location does not interfere with the use of grab rails, taps, soap holder or shower seat.

Backflow prevention device and restrictor device: Section 12.5.11 (Backflow Prevention)

Section 12.5.11 states that "unless the shower hose has a restrictor device preventing the shower head from resting on the floor or into the basin, a backflow prevention device will be required to prevent water contamination."

To meet this requirement, all Con-Serv handheld showers are fitted as standard with dual check/non-return valves providing effective backflow prevention against water contamination for low hazard areas. All Con-Serv dual check/non-return valves are licenced as per Watermark AS/NZS 2845.1 WMKA 02696.

Backflow prevention device and restrictor device: Section 12.5.11 (Restrictor Device)

Section 12.5.11 advises that "where it would be possible for the shower head to reach into the toilet pan then a restrictor device shall be fitted to prevent the hose reaching the toilet"; and that the "restrictor device shall be a proprietary item which restricts the movement of the shower hose and prevents the shower head from reaching into the toilet pan".

Con-Serv's Hose Restrictor Bracket is an easy to install, cost-effective solution that meets the requirements as outlined in AS 1428.1:2021.

The position of the Hose Restrictor Bracket is dependent on the proximity of the shower to the toilet pan. To install, simply position the bracket on the wall (with the hose inserted) and move until the handpiece no longer reaches the toilet pan. Once the location for installation has been determined, fix the Hose Restrictor Bracket to the wall.

Sanitary compartment for people with ambulant disabilities: Section 13.2

Section 13.2 has been updated stating "Grabrails shall be continuous and consist of a horizontal section plus either a vertical section or an upward angled section".

In reference to this section, the upward angled section has changed from a measurement of 700mm minimum, to a measurement of 400mm to 450mm with an angle of either 30° to 45° (upward angled section) or 90° (vertical section).

To meet this requirement, Con-Serv recommend installing ambulant grab rails that are 450mm x 450mm with a 40° bend; or 450mm x 450mm with a 90° bend.

Con-Serv's HS 045 (40° bend) and HS 454 (90° bend) ambulant grab rails meet this requirement.

For more information, visit saiglobal.com to purchase a copy of the revised standard AS 1428.1:2021 DESIGN FOR ACCESS AND MOBILITY GENERAL REQUIREMENTS FOR ACCESS — NEW BUILDING WORK STANDARD.



Biomaster antimicrobial seals for added protection against bacteria

Toilet assist grab rails in this section comply strictly with the minimum design, strength and dimension requirements of AS 1428.1:2021. Mount horizontal section of grab rail 800mm to 820mm above floor level.

ACCESSIBLE SANITARY FACILITIES COMBINATION SET: OPTION B FOR USE WITH EXPOSED CISTERNS



Code	Finish	Without GST	Features
CLAM® FLANGE			
AC 966 BS CF LH	Brushed Stainless	622.00	<ul style="list-style-type: none"> Grab rails meet the requirements of AS 1428.1:2021 Design for access and mobility, when installed correction TPE seals with Biomaster antimicrobial additive All dimensions Ø to Ø distances Wall clearance 55mm Stainless steel fixing screws supplied
AC 966 BS CF RH	Brushed Stainless	622.00	
AC 966 PS CF LH	Polish Supreme™	692.00	
AC 966 PS CF RH	Polish Supreme™	692.00	
HYGIENIC SEAL®			
AC 966 BS HS LH	Brushed Stainless	715.00	<p>COMBINATION SET INCLUDES:</p> <p>A. 870mm x 700mm grab rail B. Toilet paper holder C. Wall mount backrest D. 300mm grab rail</p> <p>Other Colours P.O.A.</p>
AC 966 BS HS RH	Brushed Stainless	715.00	
AC 966 MB HS LH	Matte Black	955.00	
AC 966 MB HS RH	Matte Black	955.00	
AC 966 PS HS LH	Polish Supreme™	766.00	
AC 966 PS HS RH	Polish Supreme™	766.00	

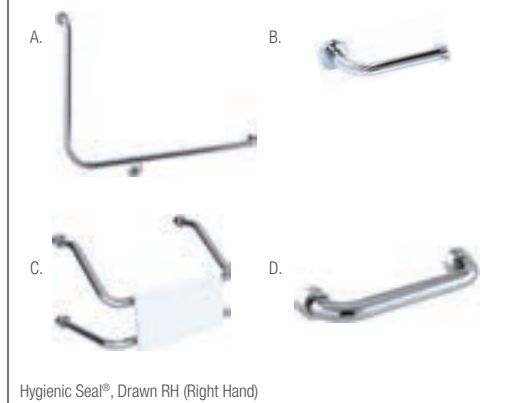

Hygienic Seal®, Drawn RH (Right Hand)

Code	Finish	Without GST
LINEAR		
AC 966 BS LR LH	Brushed Stainless	845.00
AC 966 BS LR RH	Brushed Stainless	845.00
AC 966 MB LR LH	Matte Black	1080.00
AC 966 MB LR RH	Matte Black	1080.00
AC 966 PS LR LH	Polish Supreme™	908.00
AC 966 PS LR RH	Polish Supreme™	908.00

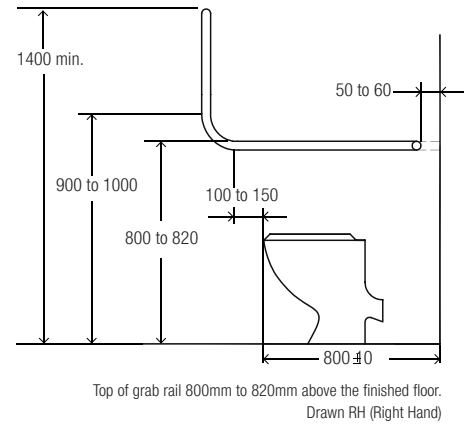

ACCESSIBLE SANITARY FACILITIES COMBINATION SET: OPTION C FOR USE WITH CONCEALED CISTERNS



Code	Finish	Without GST	Features
CLAM® FLANGE			
AC 116 BS CF LH	Brushed Stainless	695.00	<ul style="list-style-type: none"> Grab rails meet the requirements of AS 1428.1:2021 Design for access and mobility, when installed correction TPE seals with Biomaster antimicrobial additive All dimensions Ø to Ø distances Wall clearance 55mm Stainless steel fixing screws supplied
AC 116 BS CF RH	Brushed Stainless	695.00	
AC 116 PS CF LH	Polish Supreme™	765.00	
AC 116 PS CF RH	Polish Supreme™	765.00	
HYGIENIC SEAL®			
AC 116 BS HS LH	Brushed Stainless	725.00	<p>COMBINATION SET INCLUDES:</p> <p>A. 1110mm x 1030mm x 600mm grab rail B. Toilet paper holder C. Wall mount backrest</p> <p>Other Colours P.O.A.</p>
AC 116 BS HS RH	Brushed Stainless	725.00	
AC 116 MB HS LH	Matte Black	975.00	
AC 116 MB HS RH	Matte Black	975.00	
AC 116 PS HS LH	Polish Supreme™	800.00	
AC 116 PS HS RH	Polish Supreme™	800.00	



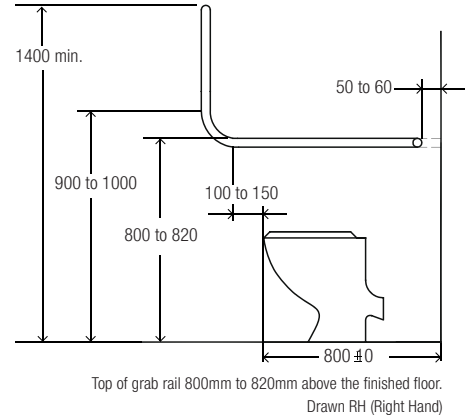

Hygienic Seal®, Drawn RH (Right Hand)

Code	Finish	Without GST
LINEAR		
AC 116 BS LR LH	Brushed Stainless	845.00
AC 116 BS LR RH	Brushed Stainless	845.00
AC 116 MB LR LH	Matte Black	1080.00
AC 116 MB LR RH	Matte Black	1080.00
AC 116 PS LR LH	Polish Supreme™	908.00
AC 116 PS LR RH	Polish Supreme™	908.00



Shower recess grab rails and shower seats in this section comply strictly with the minimum design, strength and dimension requirements of AS 1428.1:2021. Hose Restrictor Bracket to be located such that it prevents the shower head from reaching into the toilet.

Code	Finish	Without GST	Features	
ACCESSIBLE SHOWER RECESS COMBINATION SET: OPTION A				
CLAM® FLANGE				
AS 01820 BS CF LH	Brushed Stainless	1059.00	<ul style="list-style-type: none"> Grab rails meet the requirements of AS 1428.1:2021 Design for access and mobility, when installed correction TPE Seals with Biomaster antimicrobial additive Hoscare® handpiece with Biomaster antimicrobial additive Available in 3 Star 9L/min and 4 Star 6.5L/min as per WELS licence number 0046 All dimensions Ø to Ø distances Wall clearance 55mm Shower seat load rated to 250kg when correctly installed Stainless steel fixing screws supplied <p>COMBINATION SETS INCLUDES: A. 700mm x 1100mm grab rail featuring Push-PullMe® Shower Positioning Cradle with height adjustment rod for seated users, and handheld shower B. Double robe hook C. 960mm x 400mm shower seat</p>	
AS 01820 BS CF LH/6.5	Brushed Stainless	1059.00		
AS 01820 BS CF RH	Brushed Stainless	1059.00		
AS 01820 BS CFRH/6.5	Brushed Stainless	1059.00		
AS 01820 PS CF LH	Polish Supreme™	1184.00		
AS 01820 PS CF LH/6.5	Polish Supreme™	1184.00		
AS 01820 PS CF RH	Polish Supreme™	1184.00		
AS 01820 PS CFRH/6.5	Polish Supreme™	1184.00		
HYGIENIC SEAL®				
AS 01820 BS HS LH	Brushed Stainless	1099.00		
AS 01820 BS HS/6.5 LH	Brushed Stainless	1099.00		
AS 01820 BS HS RH	Brushed Stainless	1099.00		
AS 01820 BS HS/6.5 RH	Brushed Stainless	1099.00		
AS 01820 PS HS LH	Polish Supreme™	1219.00		
AS 01820 PS HS/6.5 LH	Polish Supreme™	1219.00		
AS 01820 PS HS RH	Polish Supreme™	1219.00		
AS 01820 PS HS/6.5 RH	Polish Supreme™	1219.00		
 <p>Options available on request</p> <ul style="list-style-type: none"> Hose Restrictor Bracket for applications where it would be possible for the shower head to reach into the toilet pan as per Section 12.5.11 of AS 1428.1:2021 - see page 94  <p>Hose Restrictor Bracket</p> <p>LH & RH grab rail models meet the requirements of AS 1428.1:2021 Design for access and mobility</p>				

Hygienic Seal®, Drawn RH (Right Hand)

FRONT ELEVATION

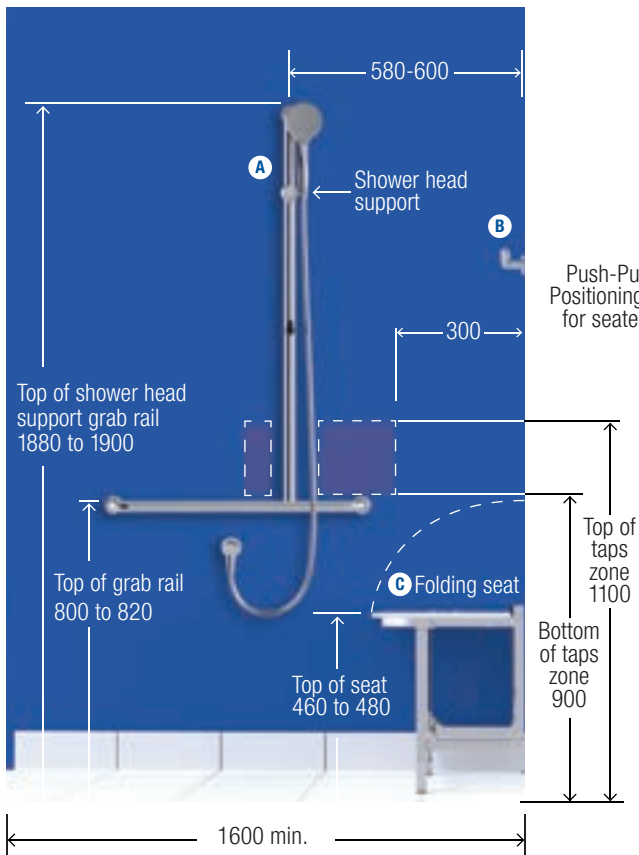

SIDE ELEVATION

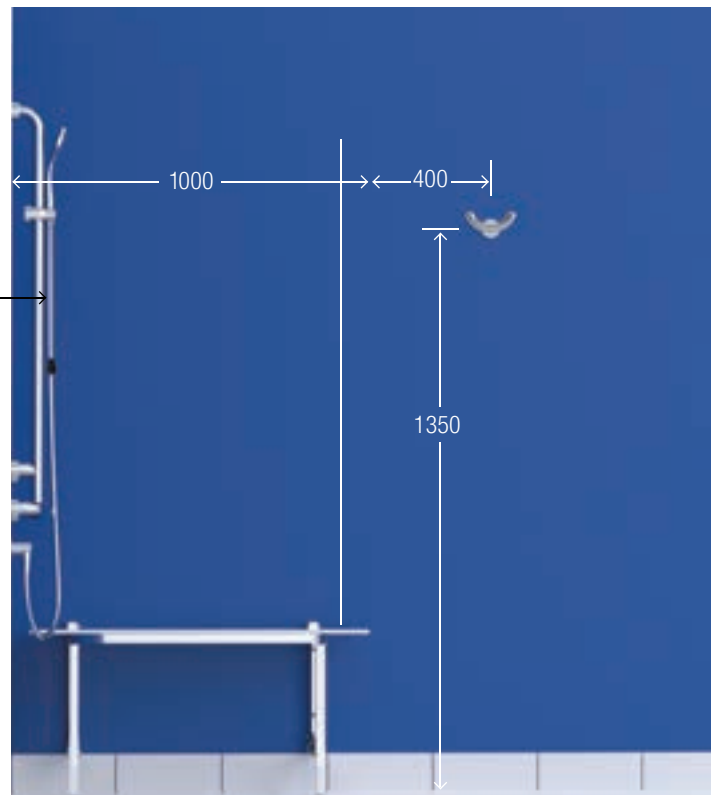



Shower recess grab rails and shower seats in this section comply strictly with the minimum design, strength and dimension requirements of AS 1428.1:2021. Hose Restrictor Bracket to be located such that it prevents the shower head from reaching into the toilet.

	Code	Finish	Without GST	Features
ACCESSIBLE SHOWER RECESS COMBINATION SET: OPTION B				
   	CLAM® FLANGE			<ul style="list-style-type: none"> Grab rails meet the requirements of AS 1428.1:2021 Design for access and mobility, when installed correction TPE Seals with Biomaster antimicrobial additive Hoscare® handpiece with Biomaster antimicrobial additive Available in 3 Star 9L/min and 4 Star 6.5L/min as per WELS licence number 0046 All dimensions Ø to Ø distances Wall clearance 55mm Shower seat load rated to 250kg when correctly installed Stainless steel fixing screws supplied <p>COMBINATION SET INCLUDES:</p> <p>A. 1000mm grab rail featuring Push-PullMe® Shower Positioning Cradle with height adjustment rod for seated users, and handheld shower</p> <p>B. Double Robe Hook</p> <p>C. 700mm grab rail</p> <p>D. 960mm x 400mm shower seat</p>  <p>Options available on request</p> <ul style="list-style-type: none"> Hose Restrictor Bracket for applications where it would be possible for the shower head to reach into the toilet pan as per Section 12.5.11 of AS 1428.1:2021 - see page 94  <p>Hose Restrictor Bracket</p> <p>LH & RH grab rail models meet the requirements of AS 1428.1:2021 Design for access and mobility</p>
	AS 01803 BS CF	Brushed Stainless	1012.00	
	AS 01803 BS CF/6.5	Brushed Stainless	1012.00	
	AS 01803 PS CF	Polish Supreme™	1127.00	
	AS 01803 PS CF/6.5	Polish Supreme™	1127.00	
	HYGIENIC SEAL®			
	AS 01803 BS HS	Brushed Stainless	1047.00	
	AS 01803 BS HS/6.5	Brushed Stainless	1047.00	
AS 01803 PS HS	Polish Supreme™	1160.00		
AS 01803 PS HS/6.5	Polish Supreme™	1160.00		

Hygienic Seal®, Drawn RH (Right Hand)

FRONT ELEVATION

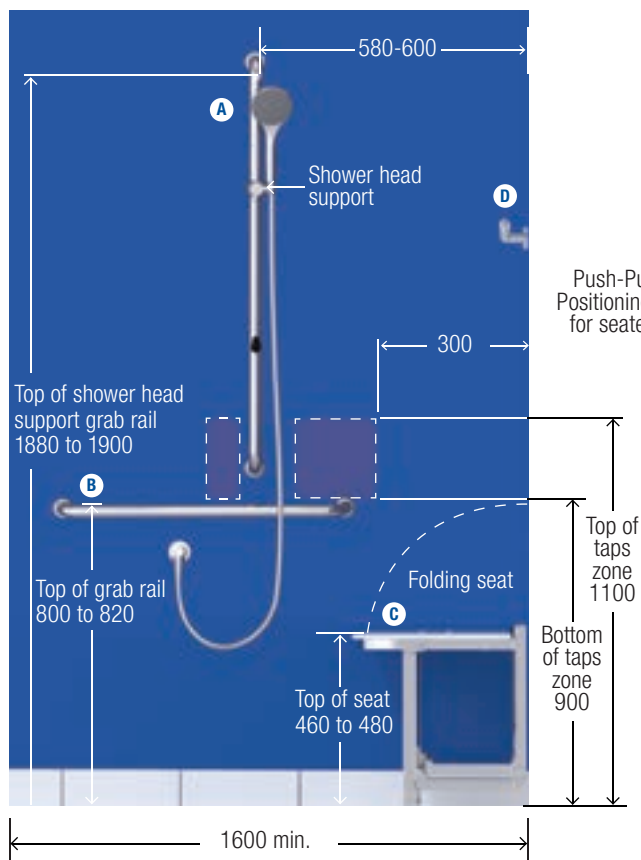

SIDE ELEVATION

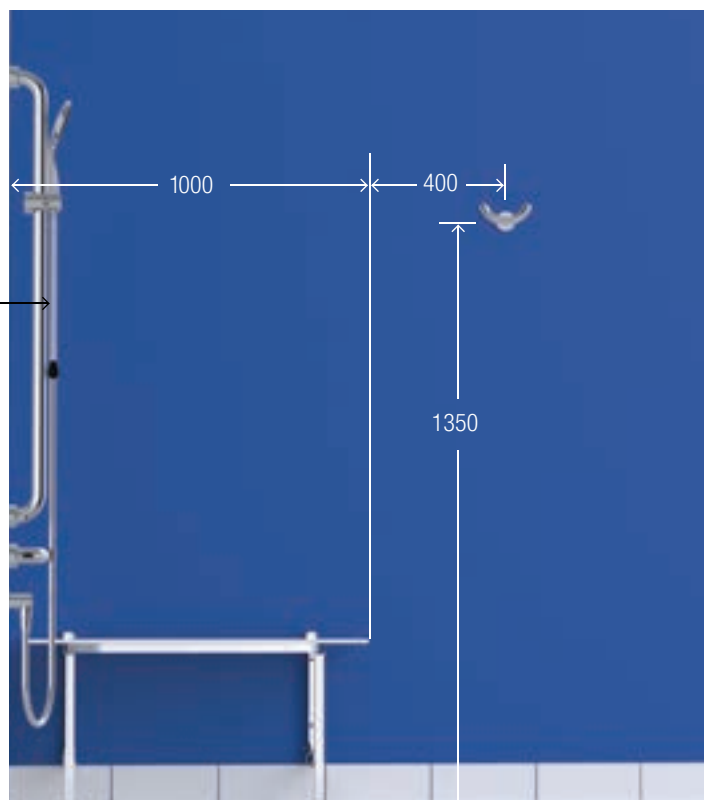

All dimensions are in millimetres unless otherwise specified.

Shower recess grab rails and shower seats in this section comply strictly with the minimum design, strength and dimension requirements of AS 1428.1:2021. For Accessible Sole-Occupancy Units, the Backrest shall be capable of being removed and refitted.



Code Finish Without GST Features

ACCESSIBLE COMBINED SANITARY FACILITIES				
	CLAM® FLANGE			<ul style="list-style-type: none"> Grab rails meet the requirements of AS 1428.1:2021 Design for access and mobility, when installed correction TPE Seals with Biomaster antimicrobial additive Hoscare® handpiece with Biomaster antimicrobial additive Available in 3 Star 9L/min and 4 Star 6.5L/min as per WELS licence number 0046 All dimensions Ø to Ø distances Wall clearance 55mm Shower seat load rated to 250kg when correctly installed Stainless steel fixing screws supplied <p>COMBINATION SET INCLUDES:</p> <p>A. Double robe hook B. 700mm x 1100mm grab rail featuring Push-PullMe® Shower Positioning Cradle with height adjustment rod for seated users, and handheld shower C. 960mm x 400mm shower seat D. Backrest with extension E. 960mm x 600mm grab rail F. Toilet paper holder G. 350mm x 135mm stainless steel shelf</p> <p>Within circulation space</p> <p>Options available on request</p> <ul style="list-style-type: none"> Hose Restrictor Bracket for applications where it would be possible for the shower head to reach into the toilet pan as per Section 12.5.1 of AS 1428.1:2021 - see page 107 <p>LH & RH grab rail models meet the requirements of AS 1428.1:2021 Design for access and mobility</p>
	CS 01820 BS CF LH	Brushed Stainless	1819.00	
	CS 01820 BS CFLH/6.5	Brushed Stainless	1819.00	
	CS 01820 BS CF RH	Brushed Stainless	1819.00	
	CS 01820 BS CFRH/6.5	Brushed Stainless	1819.00	
	CS 01820 PS CF LH	Polish Supreme™	2019.00	
	CS 01820 PS CFLH/6.5	Polish Supreme™	2019.00	
	CS 01820 PS CF RH	Polish Supreme™	2019.00	
CS 01820 PS CFRH/6.5	Polish Supreme™	2019.00		
HYGIENIC SEAL®				
CS 01820 BS HS LH	Brushed Stainless	1929.00		
CS 01820 BS HSLH/6.5	Brushed Stainless	1929.00		
CS 01820 BS HS RH	Brushed Stainless	1929.00		
CS 01820 BS HSRH/6.5	Brushed Stainless	1929.00		
CS 01820 PS HS LH	Polish Supreme™	2114.00		
CS 01820 PS HSLH/6.5	Polish Supreme™	2114.00		
CS 01820 PS HS RH	Polish Supreme™	2114.00		
CS 01820 PS HSRH/6.5	Polish Supreme™	2114.00		
Hygienic Seal®, Drawn LH (Left Hand)				



Shower recess grab rails and shower seats in this section comply strictly with the minimum design, strength and dimension requirements of AS 1428.1:2021. For Accessible Sole-Occupancy Units, the Backrest shall be capable of being removed and refitted.

	Code	Finish	Without GST	With GST	Features
HOSE RESTRICTOR (A)					
<p>Hose not included.</p>	HR 015 BN	Brushed Nickel	65.00	71.50	<ul style="list-style-type: none"> • Wall mounted hose restrictor • Brass construction • Ideal for accessible applications with handheld showers in close proximity to the WC. • Dual screw wall mount plate • Stainless steel fixings supplied
	HR 015 C	Chrome	50.00	55.00	
	HR 015 MB	Matte Black	65.00	71.50	
HIDEAWAY™ MOUNTING SYSTEM FOR GRAB RAILS					
	RETROFIT BACKREST KIT - SET OF 4 (B)				<ul style="list-style-type: none"> • Hygienic Seal® Blank End Flanges are designed to conceal the grab rail wall mount plate in situations where the grab rail needs to be removed • To install, simply unscrew the Hygienic Seal® flange, and cover with the existing wall plate with the blank end flange • To ensure a tamper resistant installation, tighten the tamper resistant grub screw with the hex key supplied • Brass construction • Please note, mounting plates are included with our Hygienic Seal® Grab Rail or Backrest
	HS 432 C BF	Chrome	132.00	Exempt	
	HS 432 MB BF	Matte Black	156.00	Exempt	
	HYGIENIC SEAL® MOUNTING PLATE (C)				
	HS 032 B MP	Brass	13.00	Exempt	
	BLANK END FLANGE (D)				
	HS 032 C BF	Chrome	20.00	Exempt	
	HS 032 MB BF	Matte Black	26.00	Exempt	
COMFORT STAINLESS STEEL SHELF 350MM					
<p>Rounded Safety Edge</p>	BA 710 BS	Brushed Stainless	165.00	181.50	<ul style="list-style-type: none"> • 350mm, centre to centre • Stainless steel construction • Meets the requirements of Section 12.4.2 (B1) Shelves, within circulation space of AS 1428.1:2021
	BA 710 MB	Matte Black	210.00	231.00	
	BA 710 PS	Polish Supreme™	175.00	192.50	



Toilet assist grab rails in this section comply strictly with the minimum design, strength and dimension requirements of AS 1428.1:2021. Mount horizontal section of grab rail 800mm to 820mm above floor level.



Biomaster antimicrobial seals for added protection against bacteria

Code Finish Without GST Features

AMBULANT ACCESSIBLE SANITARY COMPARTMENT COMBINATION SET: OPTION A				
A.	CLAM® FLANGE			<ul style="list-style-type: none"> Grab rails meet the requirements of AS 1428.1:2021 Design for access and mobility, when installed correction TPE Hygienic Seal® with Biomaster antimicrobial additive All dimensions Ø to Ø distances Wall clearance 55mm Stainless steel fixing screws supplied <p>COMBINATION SET INCLUDES:</p> <p>A. 450mm x 450mm x 40° LH grab rail</p> <p>B. 450mm x 450mm x 40° RH grab rail</p> <p>C. Toilet paper holder</p> <p>D. Robe hook</p>
	AM 045 BS CF	Brushed Stainless	263.00	
	AM 045 PS CF	Polish Supreme™	266.00	
B.	HYGIENIC SEAL®			
	AM 045 BS HS	Brushed Stainless	377.00	
	AM 045 MB HS	Matte Black	495.00	
AM 045 PS HS	Polish Supreme™	366.00		
C.	LINEAR			
	AM 045 BS LR	Brushed Stainless	485.00	
	AM 045 MB LR	Matte Black	635.00	
	AM 045 PS LR	Polish Supreme™	482.00	
D.				

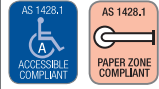

Other Colours P.O.A.

FRONT ELEVATION

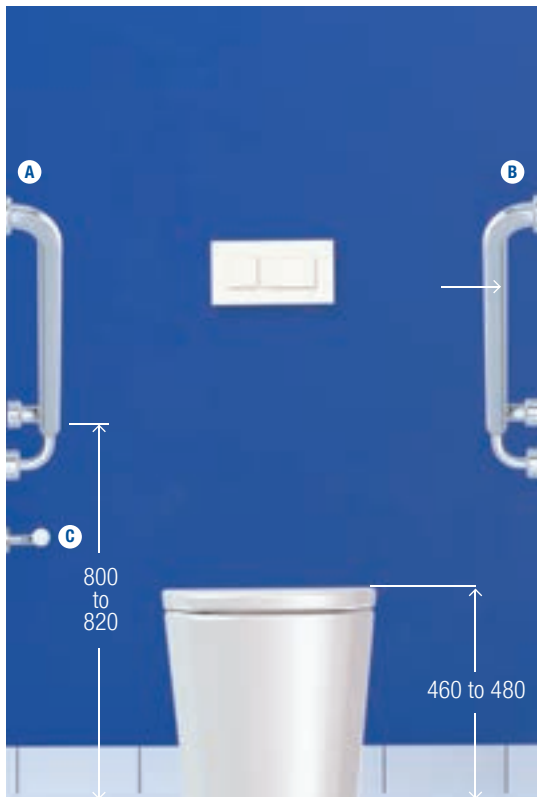

SIDE ELEVATION

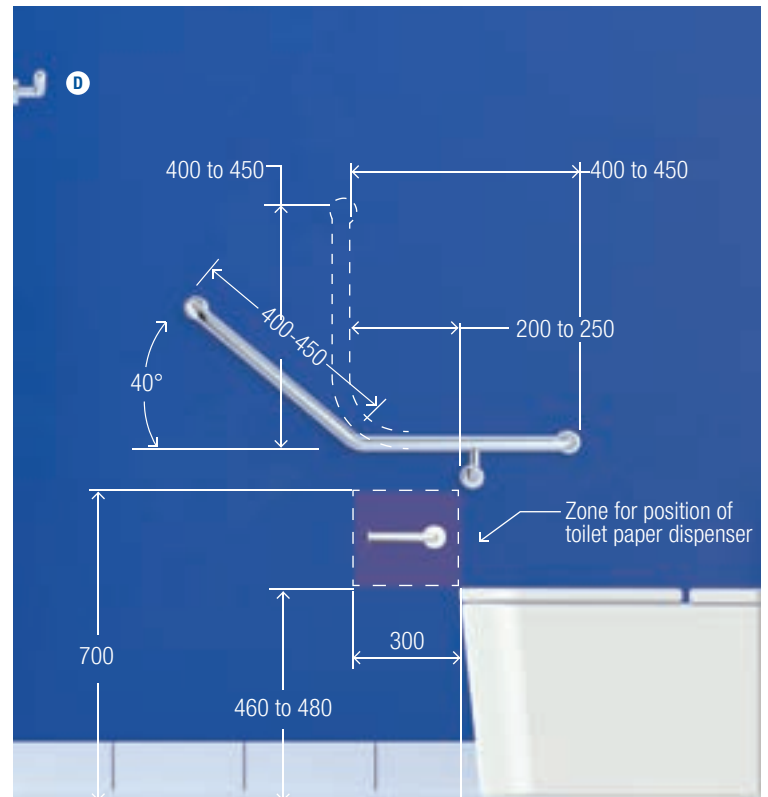

AS 1428.1:2021 COMBINATION KITS



Biomaster antimicrobial seals for added protection against bacteria

Toilet assist grab rails in this section comply strictly with the minimum design, strength and dimension requirements of AS 1428.1:2021. Mount horizontal section of grab rail 800mm to 820mm above floor level.

Code	Finish	Without GST	Features	
AMBULANT ACCESSIBLE SANITARY COMPARTMENT COMBINATION SET: OPTION B				
CLAM® FLANGE				
AM 454 BS CF	Brushed Stainless	263.00	<ul style="list-style-type: none"> Grab rails meet the requirements of AS 1428.1:2021 Design for access and mobility, when installed correction TPE Hygienic Seal® with Biomaster antimicrobial additive All dimensions Ø to Ø distances Wall clearance 55mm Stainless steel fixing screws supplied 	
AM 454 PS CF	Polish Supreme™	266.00		
HYGIENIC SEAL®				
AM 454 BS HS	Brushed Stainless	369.00		
AM 454 MB HS	Matte Black	392.00		
AM 454 PS HS	Polish Supreme™	356.00		
LINEAR				
AM 454 BS LR	Brushed Stainless	485.00	<p>COMBINATION SET INCLUDES:</p> <p>A. 450mm x 450mm x 90° LH grab rail</p> <p>B. 450mm x 450mm x 90° RH grab rail</p> <p>C. Toilet paper holder</p> <p>D. Robe hook</p>	
AM 454 MB LR	Matte Black	635.00		
AM 454 PS LR	Polish Supreme™	482.00		
  <p>Other Colours P.O.A</p>				

FRONT ELEVATION

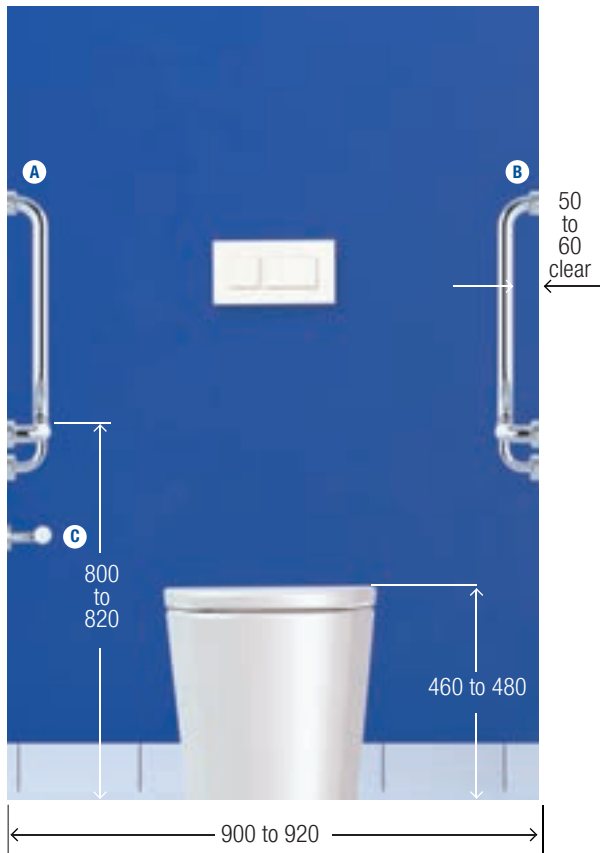

SIDE ELEVATION

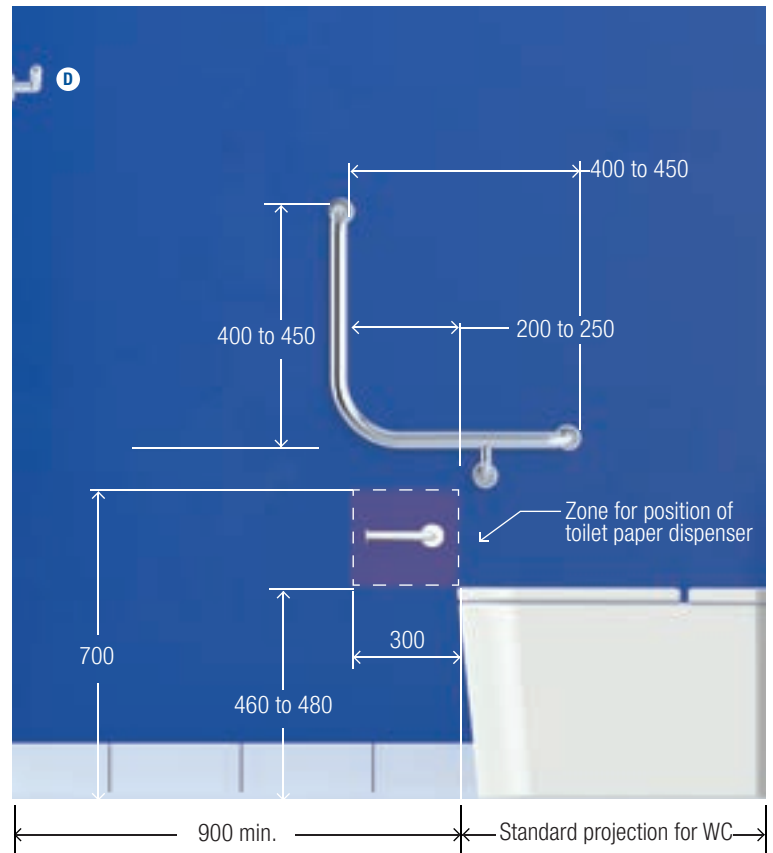

All dimensions are in millimetres unless otherwise specified.



Technical Information

The process of building or renovating can be challenging and Con-Serv is committed to providing you with the right information to make the right choice for your next project. Throughout this Retail Price Catalogue, we have included some general technical information about our range and encourage you to visit our website to explore our online resources for more information.

Specifications Sheets

Where possible, we have included line drawings, product measurements and listed features and benefits of each product represented in our 2022 Retail Price Catalogue. However, if you need more information, Specifications Sheets are available to download on each product page on our website.

All Specifications Sheets will include:

- Product Code
- Product Image
- Product dimension files (line drawings with measurements)
- Features of the product
- Any relevant Compliance information, Test Report Numbers, Certifications and Licencing information.



Con-Serv website

Need more information about a product or range?

Visit the Con-Serv website to view our complete range and access specification sheets, brochures, fact sheets, installation instructions, news articles and the latest updates on our range.

www.con-serv.com.au



TECHNICAL INFORMATION

Care and Maintenance	111
Certification and Licencing	112
Symbols	113
Index	114
Terms and Conditions	122

Care & Maintenance



Con-Serv products offer intrinsic quality born of over 40 years' experience in water efficiency and quality design. Skills combined with innovative techniques and leading designs establish the enduring character for which Con-Serv is known. There is no substitute for the reliable performance or the authentic beauty of our lustre finishes that are resistant to scratching, corrosion and tarnishing. All Con-Serv products are designed and manufactured to the highest standard and cared for correctly will ensure a lifetime of use.

WE OFFER THE FOLLOWING RECOMMENDATIONS

Bathroom Products

- Always use mild detergent soapy water or clear liquid cleansers. Wipe dry any soapy residue with a clean soft cloth.
- Do not use harsh abrasive cleansers as they contain cutting compounds which will scratch our lustrous surfaces.
- Avoid hydrochloric acid as it will lead to tarnishing and pitting. Ensure your tiler rinses clean all products and surfaces if used. Surface damage caused by acids will void warranty.
- Calcium and lime deposits can be treated with a diluted solution of CLR. Follow manufacturers recommendations for safety purposes.
- Maximum operating pressure of 500 kPa
- Maximum operating temperature of 60°C

Cleaning Stainless Steel

To have an optimum corrosion resistant stainless steel, surfaces must be clean and have an adequate supply of oxygen to maintain their "passive" surface layer. Passive film is invisible and is created when oxygen combines with chromium in the stainless steel to form chromium oxide.

Generally, stains and discolouration corrosion occurs when there is an overall breakdown of the passive film, due to incorrect cleaning.

We recommend the following cleaning practises to ensure a lifetime of use for your stainless steel products.

- Alkali cleaners such as baking soda or ammonia are most effective. Always attempt the mildest cleaning method first.
- Stainless steel's best friends are quite simply soap, mild detergent or ammonia solution in warm water applied with a soft cloth or nylon sponge for polished finishes followed by a clean water rinse.
- Dry wipe eliminates the possibility of water stains. Occasionally, the use of the least coarse nylon scouring pad may be required for brush finishes.

What to avoid

- Do not use ordinary steel wool. Iron particles can become embedded in stainless steel and cause 'iron' contamination.
- Do not use chlorides or acids as they are reactive to stainless steel.
- Strong acid solutions like hydrochloric acid or "spirit of salts" are sometimes used to clean masonry and tiling of new bathrooms and toilets, but they should never be permitted to come into contact with metals, including stainless steel.

Halogen salts, especially chlorides, easily penetrate the "passive film" of stainless steel and will allow corrosive attack to occur.

The halogens are easy to recognise because they end in the letters "INE". Listed in order of their activity are:

- Fluorine
- Chlorine
- Bromine
- Iodine
- Astatine

- Never use brick cleaning liquids which contain hydrochloric acid. Many cleaning solutions and solvents contain chlorinated hydro carbons. If a cleaner containing chlorides, bleaches and hypochlorite's are used, it must be promptly and thoroughly cleaned off.
- Please note: The Con-Serv warranty on grab rails will be null and void should they be exposed to chemical corrosion due to incompetent cleaning practices.
- The Con-Serv Hygienic Seal® flange cover has a 5° radius to comply with AS 1428.1:2021. Be most cautious of claims made by imitators.

Caring for your Matte Black bathroom fittings

- The best cleaner for your Matte Black fixtures is warm, soapy water or pH balanced soap-based cleanser, applied with a soft, damp cloth.
- We recommend that you use a clean microfibre cloth. These are readily available, cheap, machine washable, and most importantly won't scratch your matte black surfaces.
- Always wipe your fixtures down after each use to prevent mineral build-up and water spotting.
- Always check the manufacturer's instructions before starting any cleaning regime.

What to avoid

When caring for your matte black shower or grab rail, the surface is a little rough. This means the surface is susceptible to damage if not cared for properly so remember these important don'ts.

- Never use abrasive cleaners, ammoniated products, rubbing alcohol, detergents, astringents, bleached based cleaners, aggressive chemicals, abrasive cleaning pads, or harsh polishes.
- Don't allow soap scum or toothpaste to build upon the product. These will gradually wear away the coating and may diminish the durable finish.

Certification & Licencing

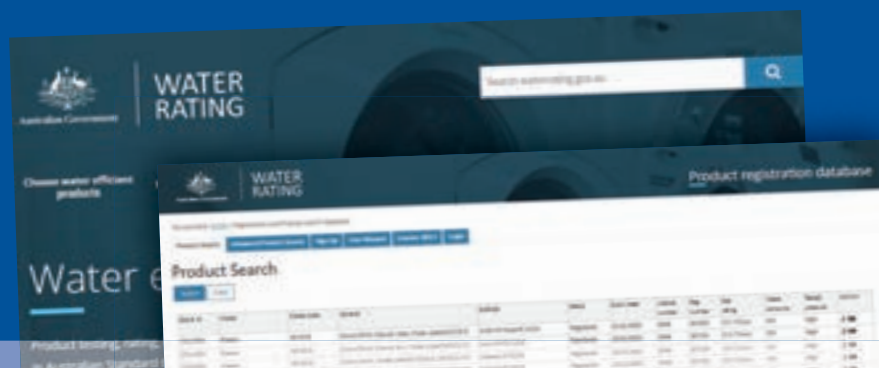

Plumbing products sold in Australia must have WaterMark certification and a registered licence under the Water Efficiency Labelling and Standards (WELS) scheme. Certification and licencing confirm the product complies with the Plumbing Code of Australia, is fit for purpose and meets the relevant Australian Standards. All Con-Serv showers, flow controls devices and dual check/non-return valves possess the WaterMark Certificate of Conformity, and fulfill all requirements for licencing purposes by the Water Efficiency Labelling and Standards scheme.

PRODUCT RANGE	WATERMARK CERTIFICATE	WELS LICENCE	RATING
Anti-Ligature Showers	AS 3662 WMKT 21147	0046	3 & 4 Star
Antimicrobial Showers		0046	3 & 4 Star
Bariatric Showers		0046	3 & 4 Star
Clam® Flange Showers		0046	3 & 4 Star
Handheld Showers		0046	3 & 4 Star
Hygienic Seal® Showers		0046	3 & 4 Star
Linear Showers		0046	3 & 4 Star
Linear Twin Waters™		0046	3 Star
Overhead Showers		0046	3 & 4 Star
Rail Showers		0046	3 & 4 Star
Shower Hoses		N/A	N/A
Tamper Resistant Showers		0046	3 & 4 Star
Twin Waters™		0046	3 Star
Vandal Resistant Showers	0046	3 & 4 Star	
Aerators	AS 5200.037.2 WMKA 00667	0046	3, 5 & 6 Star
Flow Regulated Valves		0046	3, 5 & 6 Star
Meter-Beater®		0046	3, 5 & 6 Star
Dual Check/Non-Return	AS/NZS 2845.1 WMKA 02696	N/A	N/A
Elbows & Brackets		0046	3, 5 & 6 Star
Flood Stop	WMTS 479:2018 WMK 25895	N/A	N/A

For further information regarding certification and licencing, please use the following links:

- WaterMark Certification Scheme:
<https://www.abcb.gov.au/Product-Certification/WaterMark-Certification-Scheme>
- Water Efficient Labelling Scheme:
<https://www.waterrating.gov.au/>

*All information tabled correct at time of printing

Symbols

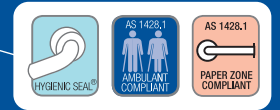

Con-Serv symbols are designed to give assistance to architects, retailers and consumers in selecting the most suitable option/s when purchasing grab rails, showers, shower seats and flow valves. They are particularly relevant when selecting items for installation in accessible sanitary facilities where Australian Standards are being implemented, when Changing Places accreditation is required, and when water flow rates are critical. The symbols below are used throughout this retail price catalogue as a quick and easy reference guide during the planning and purchasing process.

Symbol	Definition
	BIOMASTER Biomaster is an industry leader in antimicrobial protection offering superior protection against harmful bacteria such as Campylobacter, E.coli, Salmonella and Listeria. Check for this icon when you need antimicrobial protection.
	BARIATRIC This symbol confirms the grab rail as represented is manufactured with a pre-formed 78mm snap on domed cover and complies with Section 14 Grabrails of AS 1428.1:2021 Design for access and mobility.
	CLAM® FLANGE This symbol confirms the grab rail as represented is manufactured with a pre-formed 78mm snap on domed cover and complies with Section 14 Grabrails of AS 1428.1:2021 Design for access and mobility.
	HYGIENIC SEAL® This symbol confirms the grab rail is manufactured with Con-Serv's own Hygienic Seal® 50mm flange with Biomaster Thermoplastic Elastomer fitted seals. Hygienic Seal® grab rails comply with Section 14 Grabrails of AS 1428.1:2021.
	LINEAR This symbol confirms the grab rail as represented is manufactured with Con-Serv's "T" leg Linear flange with Biomaster Thermoplastic Elastomer fitted seals. Linear grab rails comply with Section 14 Grabrails of AS 1428.1:2021.
	FULL PATTERN SPRAY This symbol denotes that the shower head or handpiece has a single spray pattern and no adjustability.
	MULTI-FUNCTION SPRAY This symbol denotes that the shower head or handpiece has three adjustable spray patterns. Con-Serv multi-function spray patterns include Soft; Pulsating and Bubble spray.

Symbol	Definition
	BARIATRIC LOAD RATING This symbol when exhibited, displays the maximum weight capacity of an item. Ratings may vary between items and the maximum capacity is listed on the icon. E.g. The icon used in this table represents a maximum load rating of 400kg.
	ACCESSIBLE COMPLIANT This symbol when exhibited, confirms that the grab rail complies with Section 12.2 Accessible Unisex Sanitary Facilities of AS 1428.1:2021 Design for access and mobility.
	AMBULANT TOILET COMPLIANT This symbol when exhibited, confirms that the grab rail complies with Section 13 Sanitary compartment for people with ambulant disabilities of AS 1428.1:2021 Design for access and mobility.
	CHANGING PLACES This symbol when exhibited, confirms that the item meets the requirements outlined in the Changing Places Design Specifications 2020.
	DIMENSIONAL COMPLIANT This symbol when exhibited confirms that the item complies with the dimensional requirements of AS 1428.1:2021 Design for access and mobility for installation where applicable to water closets and 2 walled shower enclosure.
	PAPER ZONE COMPLIANT This symbol when exhibited confirms that the item complies with the positional requirements of Section 12 Sanitary facilities of AS 1428.1:2021 Design for access and mobility.
	WATERMARK WaterMark is a certification mark provided by independent certifying authorities. It confirms the product complies with the Plumbing Code and meets relevant Australian Standards relating to product quality, including health and safety.
	WATER EFFICIENCY LABELLING (WELS) The water rating label will tell you how much water that a product will use per minute, per flush or per load. The label is designed to help consumers make informed choices about the water efficiency of products they are buying.

Code A-Z	Description	Page	Code A-Z	Description	Page
AC 116 * CF *	ACCESSIBLE KIT: CLAM FLANGE 1110x1030x600mm	103	AF 5ALF	ANTI-MICROBIAL AERATOR INSERT LAMINAR	42
AC 116 * HS *	ACCESSIBLE KIT: HYGIENIC SEAL 1110x1030x600mm	103	AF 5CLL *	CLINIC LAMINAR AERATOR	42
AC 877 * CF *	ACCESSIBLE KIT: CLAM FLANGE 870x700MM	102	AF 5FVB	AERATOR INSERT BUBBLE SPRAY	42
AC 877 * HS *	ACCESSIBLE KIT: HYGIENIC SEAL 870x700MM	102	AF 5FVL	AERATOR INSERT LAMINAR	42
AC 877 * LR	ACCESSIBLE KIT: LINEAR 870x700MM	102	AF 5FVS	AERATOR INSERT STREAMJETSpray	42
AC 966 * CF *	ACCESSIBLE KIT: CLAM FLANGE 960x600MM	103	AF 5TMB	AERATOR INSERT TINY MAN	42
AC 966 * HS *	ACCESSIBLE KIT: HYGIENIC SEAL 960x600MM	103	AF 5TML	AERATOR INSERT TINY MAN LAMINAR	42
AC 966 * LR *	ACCESSIBLE KIT: LINEAR 960x600MM	103	AF 8ALF	ANTI-MICROBIAL AERATOR INSERT LAMINAR	42
AF 00 UNK	UNIVERSAL METAL SERVICE KEY	44	AF 8FVB	AERATOR INSERT BUBBLE SPRAY	42
AF 00 VK	ANTI-VANDAL FITTING KEY	44	AF 8FVL	AERATOR INSERT LAMINAR	42
AF 019 B	FLOW CONTROL DISC	45	AF 8TMB	AERATOR INSERT TINY MAN	42
AF 048	WHISPER WASH - MK1	45	AL 01806 *	ANTI-LIGATURE HOSFAB KIT 6	51
AF 053	BASIN FLOW CONTROL VALVE	45	AL 01809 *	ANTI-LIGATURE HOSFAB KIT 9	51
AF 054	FLOW CONTROL VALVE	45	AL 1200 * HZ	1200mm HORIZONTAL ANTI-LIGATURE LEFT HAND/RIGHT HAND	50
AF 055	FLANGE FLOW CONTROL VALVE	45	AL 1200 * VL	1200mm VERTICAL ANTI-LIGATURE	50
AF 059	3/4 M&F HOSE TAP FLOW REGULATOR	45	AL 450 * HZ	450mm HORIZONTAL ANTI-LIGATURE LEFT HAND/RIGHT HAND	50
AF 086	1/2 FLOW INTERCHANGE SPIGOT	45	AL 450 * VL	450mm VERTICAL ANTI-LIGATURE	50
AF 15DFB	DOMESTIC AERATOR MINI VALVE	42	AL 454 *	ANTI-LIGATURE 450x450mm WITH TOILET ASSIST LEFT HAND/RIGHT HAND	50
AF 15DMB	DOMESTIC AERATOR MINI VALVE	43	AL 600 * HZ	600mm HORIZONTAL ANTI-LIGATURE LEFT HAND/RIGHT HAND	50
AF 20 C	SINK SPRAY SWIVEL AERATOR	43	AL 600 * VL	600mm VERTICAL ANTI-LIGATURE	50
AF 22DFB	DOMESTIC AERATOR FEMALE BUBBLE	43	AL 900 * HZ	900mm HORIZONTAL ANTI-LIGATURE LEFT HAND/RIGHT HAND	50
AF 22DFL	DOMESTIC AERATOR FMLE LAMINAR	43	AL 900 * VL	900mm VERTICAL ANTI-LIGATURE	50
AF 22DFS	DOMESTIC AERATOR FEMALE STREAM	43	AL 966 *	ANTI-LIGATURE 960x600mm WITH TOILET ASSIST LEFT HAND/RIGHT HAND	50
AF 22F	AERATOR FLOW CONTROL ADAPTOR	43	AM 045 * CF	AMBULANT ACCESSIBLE KIT: CLAM FLANGE	108
AF 22VFB	ANTI VAND AERATOR BUBBLE SPRAY	43	AM 045 * HS	AMBULANT ACCESSIBLE KIT: HYGIENIC SEAL	108
AF 22VFS	ANTI VAND AERATOR STREAMJETSpray	43	AM 045 * LR	AMBULANT ACCESSIBLE KIT: LINEAR	108
AF 24DMB	DOMESTIC AERATOR MALE BUBBLE	44	AM 454 * CF	AMBULANT ACCESSIBLE KIT: CLAM FLANGE	109
AF 24DML	DOMESTIC AERATOR MALE LAMINAR	44	AM 454 * HS	AMBULANT ACCESSIBLE KIT: HYGIENIC SEAL	109
AF 24DMS	DOMESTIC AERATOR MALE STREAM	44	AM 454 * LR	AMBULANT ACCESSIBLE KIT: LINEAR	109
AF 24M	AERATOR FLOW CONTROL ADAPTOR	44	AS 01803 * CF	ACCESSIBLE SHOWER KIT: CLAM FLANGE	105
AF 24VMB	ANTI VAND AERATOR BUBBLE SPRAY	44	AS 01803 * HS	ACCESSIBLE SHOWER KIT: HYGIENIC SEAL	105
AF 24VMS	ANTI VAND AERATOR STREAMJETSpray	44	AS 01820 * CF	ACCESSIBLE SHOWER KIT: CLAM FLANGE	104
AF 2FVS	AERATOR INSERT STREAMJETSpray	42	AS 01820 * HS	ACCESSIBLE SHOWER KIT: HYGIENIC SEAL	104

Code A-Z	Description	Page	Code A-Z	Description	Page
BA 101	MODENA SOAP DISH HOLDER	6	BA 780	COMFORT MIRROR DUAL SIDED	10
BA 104	MODENA TOWEL RAIL SINGLE 600mm	7	BA 782	COMFORT CLOTHES LINE RETRACT	11
BA 105	MODENA TOWEL RAIL SINGLE 750mm	7	BB 011 *	BATHROOM RECTANGULAR BASKET - LARGE	11
BA 106	MODENA TOWEL RAIL DOUBLE 600mm	7	BB 017 *	BATHROOM CORNER BASKET - LARGE	11
BA 107	MODENA TOWEL RAIL DOUBLE 750mm	7	BG 01809 *	BARIATRIC HOSFAB K9	58
BA 108	MODENA GLASS SHELF 530mm	6	BG 01816 *	BARIATRIC HOSFAB K16	58
BA 111	MODENA HAND TOWEL RAIL 280mm	7	BG 071 *	BARIATRIC 700x1100mm INVERTED T GRAB RAIL	56
BA 112	MODENA PAPER HOLDER	6	BG 300 *	BARIATRIC 300mm STRAIGHT GRAB RAIL	56
BA 114	MODENA TOILET BRUSH/HOLDER	6	BG 450 *	BARIATRIC 450mm STRAIGHT GRAB RAIL	56
BA 115	MODENA ROBE HOOK SINGLE	6	BG 454 *	BARIATRIC 450x450mm ACCESSIBLE GRAB RAIL	57
BA 700 FR GO	TUMBLER GLASS ONLY	10	BG 600 *	BARIATRIC 600mm STRAIGHT GRAB RAIL	56
BA 701	COMFORT SOAP DISH HOLDER	10	BG 700 *	BARIATRIC 700mm STRAIGHT GRAB RAIL	56
BA 704	COMFORT TOWEL RAIL SINGLE 600mm	8	BG 877 *	BARIATRIC 870x700mm ACCESSIBLE GRAB RAIL	57
BA 705	COMFORT TOWEL RAIL SINGLE 800mm	8	BG 900 *	BARIATRIC 900mm STRAIGHT GRAB RAIL	56
BA 706	COMFORT TOWEL RAIL DOUBLE 600mm	8	BG 966 *	BARIATRIC 960x600mm ACCESSIBLE GRAB RAIL	57
BA 707	COMFORT TOWEL RAIL DOUBLE 800mm	8	BR 395 *	FLOOR MOUNTED BACKREST	54
BA 708	COMFORT STAINLESS STEEL SHELF 500mm	9	BR 400 * CF	WALL MOUNTED BACKREST	54
BA 710	COMFORT STAINLESS STEEL SHELF 350mm	9	BR 400 * HS	WALL MOUNTED BACKREST	54
BA 712	COMFORT PAPER HOLDER	8	BR 404 * HS	WALL MOUNTED BACKREST HIDEAWAY MOUNTING SYSTEM	55
BA 714 BH	TOILET BRUSH HANDLE ONLY	6	BR 440 * CF	WALL MOUNTED BACKREST/450mm	55
BA 714 FR GO	TOILET BRUSH GLASS ONLY	6	BR 440 * HS	WALL MOUNTED BACKREST/450mm	55
BA 714 WT BO	TOILET BRUSH HEAD ONLY	6	BR 444 * HS	WALL MOUNTED BACKREST EXTENDED HIDEAWAY MOUNT	55
BA 715	COMFORT DOUBLE ROBE HOOK	8	CF 01803 *	CLAM FLANGE SHOWER KIT 3	64
BA 718	COMFORT STAINLESS STEEL SHELF 280mm CORNER	9	CF 01809 *	CLAM FLANGE SHOWER KIT 9	64
BA 719	COMFORT FOOTREST	11	CF 01816 *	CLAM FLANGE SHOWER KIT 16	65
BA 722	COMFORT PAPER HOLDER DOUBLE	8	CF 01820 *	CLAM FLANGE SHOWER KIT 20	65
BA 729	COMFORT GLASS SHELF 530mm	9	CF 045 *	CLAM FLANGE 450x450mm ASSIST GRAB RAIL	60
BA 729 * BO	SHELF BARRIER ONLY	9	CF 071 *	CLAM FLANGE 700x1100mm SHOWER GRAB RAIL	62
BA 739	COMFORT GLASS SHELF 260mm CORNER	9	CF 1000 *	CLAM FLANGE 1000mm STRAIGHT GRAB RAIL	60
BA 739 * BO	SHELF BARRIER ONLY	9	CF 116 *	CLAM FLANGE 1110x1030x600mm	61
BA 742	SOAP DISPENSER	10	CF 300 *	CLAM FLANGE 300mm STRAIGHT GRAB RAIL	60
BA 750	COMFORT WALL MOUNT TOILET BRUSH	10	CF 450 *	CLAM FLANGE 450mm STRAIGHT GRAB RAIL	60
BA 769	SHELF MOUNT BRACKETS PAIR	9	CF 454 *	CLAM FLANGE 450x450mm ASSIST	61

* The asterisk represent code variations when there are multiple options available for finishes and/or orientation.

Code A-Z	Description	Page	Code A-Z	Description	Page
CF 600 *	CLAM FLANGE 600mm STRAIGHT GRAB RAIL	60	FM 070 BE	BASIN FLOW MEASURING CUP	47
CF 700 *	CLAM FLANGE 700mm STRAIGHT GRAB RAIL	60	FM 075 BE	SHOWER FLOW MEASURING JUG	47
CF 711 *	CLAM FLANGE 760x1000x1100mm CORNER GRAB RAIL	62	FS 038	FLOOD STOP VALVE	46
CF 761 *	CLAM FLANGE 760x1000mm CORNER GRAB RAIL	61	GS 071J *	HOME CARE STREAMJET	73
CF 818 *	CLAM FLANGE 800mm FREE STANDING	91	GS 071P	HOME CARE PRINCESS	73
CF 877 *	CLAM FLANGE 870x700mm ASSIST GRAB RAIL	60	GS 071S	HOME CARE STREAMJET XL TURBO	73
CF 900 *	CLAM FLANGE 900mm STRAIGHT GRAB RAIL	60	GS 071T	HOME CARE STREAMJET TURBO	73
CF 966 *	CLAM FLANGE 960x600mm ASSIST	61	GS 071X	HOME CARE STREAMJET XL	73
CR 300 *	COMFORT BATHROOM RAIL 300mm	11	GS 071Z	HOME CARE BREEZE	73
CR 450 *	COMFORT BATHROOM RAIL 300mm	11	GS 900J *	HOME CARE STREAMJET	72
CR 600 *	COMFORT BATHROOM RAIL 600mm	11	GS 900P	HOME CARE PRINCESS	72
CR 900 *	COMFORT BATHROOM RAIL 900mm	11	GS 900S	HOME CARE STREAMJET XL TURBO	72
CR 900J *	STREAMJET/900mm COMFORT RAIL	22	GS 900T	HOME CARE STREAMJET TURBO	72
CR 900P	PRINCESS/900mm COMFORT RAIL	22	GS 900X *	HOME CARE STREAMJET XL	72
CR 900S	STREAMJET XL TURBO/900mm COMFORT RAIL	22	GS 900Z	HOME CARE BREEZE	72
CR 900T	STREAMJET TURBO/900mm COMFORT RAIL	22	HC 010 *	BRASS FRICTION SLIDE CRADLE	35
CR 900X *	STREAMJET XL/900mm COMFORT RAIL	22	HC 020 *	BRASS SLIDE RAIL H/P CRADLE	35
CR 900Z	BREEZE PULS/900mm COMFORT RAIL	22	HC 024 *	GRAB RAIL GLIDE SLIDE HANDSET CRADLE	52, 94
CS 007	COBRA VANDAL PROOF	21	HC 025 *	ABS PUSH BUTTON SLIDE CRADLE	35
CS 008	PIONEER TAMPER PROOF	21	HC 932 *	32mm FRICTION SLIDE CRADLE	94
CS 009	VANGUARD VANDAL PROOF	21	HF 071J *	PREMIUM STREAMJET	75
CS 061	ZODIAC TAMPER PROOF/55mm ARM	21	HF 071P	PREMIUM PRINCESS	75
DC 042	DUAL CHECK/FLOW REG 1/2 M&F	46	HF 071S	PREMIUM STREAMJET XL TURBO	75
DC 043 *	DUAL CHECK/NON RETURN 1/2 F&M	46	HF 071T	PREMIUM STREAMJET TURBO	75
DC 057	DUAL CHECK/NON RETURN 1/2 M&M	46	HF 071X *	PREMIUM STREAMJET XL	75
DV 021	SWITCHCOCK VALVE	39	HF 071Z	PREMIUM BREEZE	75
DV 044	ON/OFF BUTTON CONTROL VALVE	32	HF 900J *	PREMIUM STREAMJET	74
EB 044	ANTI LIGATURE WALL OUTLET	32	HF 900T	PREMIUM STREAMJET TURBO	74
EB 045	WALL OUTLET ELBOW/DUAL CHECK	32	HF 900X *	PREMIUM STREAMJET XL	74
EB 046 *	WALL OUTLET ELBOW/DUAL CHECK	32	HF 900Z	PREMIUM BREEZE	74
EB 073 *	WALL OUTLET BRACKET/DUAL CHECK	32	HF 932 *	HYGIENIC SEAL 900mm RAIL SLIDE CRADLE	95
EB 074	WALL MOUNT HANDSET BRACKET	32	HM 019 *	HOB MOUNT SET	39
EB 085	WALL MOUNT ABS HANDSET BRACKET	32	HP 025 *	KLIPPER ON/OFF HANDPIECE	37

Code A-Z	Description	Page	Code A-Z	Description	Page
HP 030 *	HOSCARE HANDPIECE	37	HS 01804S	STREAMJET XL TURBO KIT 4	98
HP 034	PRINCESS HANDPIECE	37	HS 01804T	STREAMJET TURBO KIT 4	98
HP 035 *	HOSFAB HANDPIECE	37	HS 01804X *	STREAMJET XL KIT 4	98
HP 037	BREEZE PULSATOR HANDPIECE	37	HS 01805 *	COMMERCIAL KIT 5	78
HP 038 *	STREAMJET HANDPIECE	36	HS 01806 *	ANTIMICROBIAL KIT 6	53
HP 041	QUEWB HANDPIECE	36	HS 01806H *	COMMERCIAL HOSCARE KIT 6	96
HP 042	STREAMJET TURBO HANDPIECE	36	HS 01806J *	STREAMJET KIT 6	96
HP 130 *	STREAMJET XL HANDPIECE	36	HS 01806P	PRINCESS KIT 6	96
HP 142	STREAMJET XL TURBO PULSATOR HANDPIECE	36	HS 01806S	STREAMJET XL TURBO KIT 6	96
HR 015 *	HOSE RESTRICTOR BRACKET	94/107	HS 01806T	STREAMJET TURBO PULSATOR KIT 6	96
HS 010J *	STREAMJET/CRYSTAL SLIDE RAIL	23	HS 01806X	STREAMJET XL KIT 6	96
HS 010P	PRINCESS/CRYSTAL SLIDE RAIL	23	HS 01808H *	COMMERCIAL HOSCARE KIT 8	99
HS 010S	STREAMJET XL TURBO/CRYSTAL SLIDE RAIL	23	HS 01808J *	STREAMJET KIT 8	99
HS 010T	STREAMJET TURBO/CRYSTAL SLIDE RAIL	23	HS 01808P	PRINCESS KIT 8	99
HS 010U	QUEWB/SQUARE EDGE SLIDE RAIL	29	HS 01808S	STREAMJET XL TURBO KIT 8	99
HS 010X	STREAMJET XL/CRYSTAL SLIDE RAIL	23	HS 01808T	STREAMJET TURBO KIT 8	99
HS 010Z	BREEZE PULS/CRYSTAL SLIDE RAIL	23	HS 01808X *	STREAMJET XL KIT 8	99
HS 011J *	STREAMJET/WALL OUTLET BRACKET	24	HS 01809 *	ANTIMICROBIAL KIT 9	53
HS 011P	PRINCESS/WALL OUTLET BRACKET	24	HS 01810H *	COMMERCIAL HOSCARE KIT 10	97
HS 011S	STREAMJET XL TURBO/WALL OUTLET BRACKET	24	HS 01810J *	STREAMJET KIT 10	97
HS 011T	STREAMJET TURBO/WALL OUTLET BRACKET	24	HS 01810P	PRINCESS KIT 10	97
HS 011X *	STREAMJET XL/WALL OUTLET BRACKET	24	HS 01810S	STREAMJET XL TURBO KIT 10	97
HS 011Z *	BREEZE PULSATOR/WALL OUTLET BRACKET	24	HS 01810T	STREAMJET TURBO KIT 10	97
HS 017H *	HOSCARE HANDHELD KIT FOR RAILS	25	HS 01810X	STREAMJET XL KIT 10	97
HS 017J *	STREAMJET HANDHELD KIT FOR RAILS	25	HS 01812 *	ANTIMICROBIAL KIT 12	53
HS 017P	PRINCESS HANDHELD KIT FOR RAILS	25	HS 01813 *	COMMERCIAL KIT 13	78
HS 017S	STREAMJET XL TURBO HANDHELD KIT FOR RAILS	25	HS 01816 *	COMMERCIAL KIT 16	79
HS 017T	STREAMJET TURBO HANDHELD KIT FOR RAILS	25	HS 01820 *	COMMERCIAL KIT 20	79
HS 017X *	STREAMJET XL HANDHELD KIT FOR RAILS	25	HS 020J *	STREAMJET/POLAR RAIL	26
HS 01803 *	COMMERCIAL KIT 3	77	HS 020P	PRINCESS/POLAR RAIL	26
HS 01804H *	HOSCARE KIT 4	98	HS 020S	STREAMJET XL TURBO/POLAR RAIL	26
HS 01804J *	STREAMJET KIT 4	98	HS 020T	STREAMJET TURBO/POLAR RAIL	26
HS 01804P	PRINCESS KIT 4	98	HS 020X *	STREAMJET XL/POLAR RAIL	26

* The asterisk represent code variations when there are multiple options available for finishes and/or orientation.

Code A-Z	Description	Page	Code A-Z	Description	Page
HS 020Z C	BREEZE PULS/POLAR RAIL	26	HS 1100 *	HYGIENIC SEAL 1100mm STRAIGHT GRAB RAIL	67
HS 026J *	STREAMJET/RIVIERA SLIDE RAIL	27	HS 116 *	HYGIENIC SEAL 1110x1030x600mm ASSIST	69
HS 026P	PRINCESS/RIVIERA SLIDE RAIL	27	HS 1200 *	HYGIENIC SEAL 1200mm STRAIGHT GRAB RAIL	67
HS 026S	STREAMJET XL TURBO/RIVIERA SLIDE RAIL	27	HS 200 *	HYGIENIC SEAL 200mm STRAIGHT GRAB RAIL	66
HS 026T	STREAMJET TURBO/RIVIERA SLIDE RAIL	27	HS 300 *	HYGIENIC SEAL 300mm STRAIGHT GRAB RAIL	66
HS 026X *	STREAMJET XL/RIVIERA SLIDE RAIL	27	HS 300 **	HYGIENIC SEAL 300mm WITH TOILET ROLL	67
HS 026Z *	BREEZE PULS/RIVIERA SLIDE RAIL	27	HS 400 *	HYGIENIC SEAL 400mm STRAIGHT GRAB RAIL	66
HS 030J *	STREAMJET/ANTONIO RAIL	28	HS 432 * BF	RETROFIT BACKREST KIT - SET OF 4	93
HS 030P	PRINCESS/ANTONIO RAIL	28	HS 432 * SF	RETROFIT SHOWER SEAT KIT - SET OF 4	93
HS 030S	STREAMJET XL TURBO/ANTONIO RAIL	28	HS 450 *	HYGIENIC SEAL 450mm STRAIGHT GRAB RAIL	66
HS 030T	STREAMJET TURBO/ANTONIO RAIL	28	HS 450 **	HYGIENIC SEAL 450mm WITH TOILET ROLL	67
HS 030X	STREAMJET XL/ANTONIO RAIL	28	HS 454 *	HYGIENIC SEAL 450x450mm ASSIST	68
HS 030Z	BREEZE/ANTONIO RAIL	28	HS 500 *	HYGIENIC SEAL 500mm STRAIGHT GRAB RAIL	66
HS 032 * FC	HYGIENIC SEAL FLANGE COVER	92	HS 600 *	HYGIENIC SEAL 600mm STRAIGHT GRAB RAIL	66
HS 032 B BB10	HYGIENIC SEAL BACK/BACK SYSTEM - 10mm	93	HS 700 *	HYGIENIC SEAL 700mm STRAIGHT GRAB RAIL	66
HS 032 B BB15	HYGIENIC SEAL BACK/BACK SYSTEM - 15mm	93	HS 711 *	HYGIENIC SEAL 760x1000x1100mm SHOWER RECESS	70
HS 032 B BB30	HYGIENIC SEAL BACK/BACK SYSTEM - 30mm	93	HS 750 *	HYGIENIC SEAL 750mm STRAIGHT GRAB RAIL	66
HS 032 B MP	HYGIENIC SEAL WALL MOUNT PLATE	92	HS 761 *	HYGIENIC SEAL 760x1000mm CORNER	69
HS 032 BS BM	SHOWER SEAT WALL MOUNT PLATE	92	HS 775 *	HYGIENIC SEAL 750x750mm WITH TOILET ASSIST	68
HS 032 C BE10	HYGIENIC SEAL SINGLE SIDED SYSTEM	93	HS 800 *	HYGIENIC SEAL 800mm STRAIGHT GRAB RAIL	67
HS 032 C BE15	HYGIENIC SEAL SINGLE SIDED SYSTEM	93	HS 877 *	HYGIENIC SEAL 870x700mm ASSIST	68
HS 032 C BE30	HYGIENIC SEAL SINGLE SIDED SYSTEM	93	HS 880 *	HYGIENIC SEAL 800x800mm CORNER	69
HS 032 * BF	HYGIENIC SEAL BLANK END FLANGE	92	HS 900 *	HYGIENIC SEAL 900mm STRAIGHT GRAB RAIL	67
HS 032 PS SP	HYGIENIC SEAL STAND OFF PLATE	92	HS 966 *	HYGIENIC SEAL 960x600mm ASSIST	68
HS 036J *	STREAMJET/RIVIERA RAIL BOTTOM INLET	27	HT 600 * D	HYGIENIC SEAL 600mm/D TOWEL RAIL	71
HS 036P	PRINCESS/RIVIERA RAIL BOTTOM INLET	27	HT 600 * U	HYGIENIC SEAL 600mm/U TOWEL RAIL	71
HS 036S	STREAMJET XL TURBO/RIVIERA RAIL BOTTOM INLET	27	HT 800 * D	HYGIENIC SEAL 800mm/D TOWEL RAIL	71
HS 036T	STREAMJET/RIVIERA RAIL BOTTOM INLET	27	HT 800 * U	HYGIENIC SEAL 800mm/U TOWEL RAIL	71
HS 036X *	STREAMJET XL/RIVIERA RAIL BOTTOM INLET	27	IC 01803 *	CLAM FLANGE ACCESSIBLE KIT 3	63
HS 036Z	BREEZE/RIVIERA RAIL BOTTOM INLET	27	IC 01820 *	CLAM FLANGE ACCESSIBLE KIT 20	63
HS 045 *	HYGIENIC SEAL 450x450mm	68	ID 01803 *	INDEPENDENT ACCESSIBLE KIT 3	76
HS 071 *	HYGIENIC SEAL 700x1100mm SHOWER RECESS	70	ID 01804H *	ACCESSIBLE HOSCARE KIT 4	100
HS 1000 *	HYGIENIC SEAL 1000mm STRAIGHT GRAB RAIL	67	ID 01804J *	ACCESSIBLE STREAMJET KIT 4	100

Code A-Z	Description	Page	Code A-Z	Description	Page
ID 01804P	ACCESSIBLE PRINCESS KIT 4	100	LR 877 *	LINEAR 870x700mm ASSIST GRAB RAIL	81
ID 01804S	ACCESSIBLE STREAMJET XL TURBO KIT 4	100	LR 900 *	LINEAR 900mm STRAIGHT GRAB RAIL	80
ID 01804T	ACCESSIBLE STREAMJET TURBO KIT 4	100	LR 966 *	LINEAR 960x600mm ASSIST GRAB RAIL	81
ID 01804X	ACCESSIBLE STREAMJET XL KIT 4	100	LT 071CJ *	LINEAR TWIN COSMIC/STREAMJET 700x1100mm	86-87
ID 01808H AC	ACCESSIBLE HOSCARE KIT 8	101	LT 071CP *	LINEAR TWIN COSMIC/PRINCESS 700x1100mm	86-87
ID 01808J	ACCESSIBLE STREAMJET KIT 8	101	LT 071CS *	LINEAR TWIN COSMIC/STREAMJET XL TURBO 700x1100mm	86-87
ID 01808P	ACCESSIBLE PRINCESS KIT 8	101	LT 071CT *	LINEAR TWIN COSMIC/STREAMJET TURBO 700x1100mm	86-87
ID 01808S	ACCESSIBLE STREAMJET XL TURBO KIT 8	101	LT 071CX *	LINEAR TWIN COSMIC/STREAMJET XL 700x1100mm	86-87
ID 01808T	ACCESSIBLE STREAMJET TURBO KIT 8	101	LT 071CZ *	LINEAR TWIN COSMIC/BREEZE 700x1100mm	86-87
ID 01808X	ACCESSIBLE STREAMJET XL KIT 8	101	LT 110CJ *	LINEAR TWIN COSMIC/STREAMJET 1100mm	84-85
ID 01820 *	INDEPENDENT ACCESSIBLE KIT 20	76	LT 110CP *	LINEAR TWIN COSMIC/PRINCESS 1100mm	84-85
LF 079J *	LINEAR KIT/STREAMJET 700mm+900mm	83	LT 110CS *	LINEAR TWIN COSMIC/STREAMJET XL TURBO 1100mm	84-85
LF 079P	LINEAR KIT/PRINCESS 700mm+900mm	83	LT 110CT *	LINEAR TWIN COSMIC/STREAMJET TURBO 1100mm	84-85
LF 079S	LINEAR KIT/STREAMJET XL TURBO 700mm+900mm	83	LT 110CX *	LINEAR TWIN COSMIC/STREAMJET XL 1100mm	84-85
LF 079T	LINEAR KIT/STREAMJET TURBO 700mm+900mm	83	LT 110CZ *	LINEAR TWIN COSMIC/BREEZE 1100mm	84-85
LF 079X *	LINEAR KIT/STREAMJET XL 700mm+900mm	83	LT 111CJ *	LINEAR TWIN COSMIC/STREAMJET 1100mm	84-85
LF 079Z	LINEAR KIT/BREEZE 700mm+900mm	83	LT 111CP *	LINEAR TWIN COSMIC/PRINCESS 1100mm	84-85
LF 900J *	LINEAR STREAMJET	82	LT 111CS *	LINEAR TWIN COSMIC/STREAMJET XL TURBO 1100mm	84-85
LF 900P	LINEAR PRINCESS	82	LT 111CT *	LINEAR TWIN COSMIC/STREAMJET TURBO 1100mm	84-85
LF 900S	LINEAR STREAMJET XL TURBO	82	LT 111CX *	LINEAR TWIN COSMIC/STREAMJET XL 1100mm	84-85
LF 900T	LINEAR STREAMJET TURBO	82	LT 111CZ *	LINEAR TWIN COSMIC/BREEZE 1100mm	84-85
LF 900X *	LINEAR STREAMJET XL	82	LT 600 * D	LINEAR 600MM/D TOWEL RAIL	81
LF 900Z	LINEAR BREEZE	82	LT 600 * U	LINEAR 600mm/U TOWEL RAIL	81
LF 932 *	LINEAR 900mm RAIL SLIDE CRADLE	95	LT 800 * D	LINEAR 800mm/D TOWEL RAIL	81
LL 850	850mm LIFT-N-LOCK GRAB RAIL	91	LT 800 * U	LINEAR 800mm/U TOWEL RAIL	81
LR 045 *	LINEAR 450x450mm ASSIST	81	MB 043 FP	SPINDLE FLUSH PLUG	47
LR 079 *	LINEAR SHOWER RECESS KIT: 700mm+900mm	80	MB 043 IK	METER-BEATER INSTALLATION KIT	47
LR 300 *	LINEAR 300mm STRAIGHT GRAB RAIL	80	MB 043 RT	METER-BEATER REAMER TOOL	47
LR 450 *	LINEAR 450mm STRAIGHT GRAB RAIL	80	MB 043 TT	METER-BEATER TAPPING TOOL	47
LR 454 *	LINEAR 450x450mm ASSIST GRAB	81	MB 045 OR*	METER-BEATER O-RING SEAL	47
LR 600 *	LINEAR 600mm STRAIGHT GRAB RAIL	80	MB 045	METER-BEATER 1/2 SCREW DOWN	47
LR 700 *	LINEAR 700mm STRAIGHT GRAB RAIL	80	MB 047	METER-BEATER 1/2 CERAMIC DISC	47
LR 800 *	LINEAR 800mm STRAIGHT GRAB RAIL	80	OH 005A	PADDINGTON ROSE ONLY	13

* The asterisk represent code variations when there are multiple options available for finishes and/or orientation.

Code A-Z	Description	Page	Code A-Z	Description	Page
OH 005D	PADDINGTON/300mm CLICKLOCK ARM	13	OH 038T *	RAINSTORM 150MM VERTICAL ARM	20
OH 005E	PADDINGTON/290mm SWAN NECK ARM	13	OH 038U *	RAINSTORM 300MM VERTICAL ARM	20
OH 005H	PADDINGTON/450mm HORIZONTAL ARM	13	OH 038W *	RAINSTORM 450MM VERTICAL ARM	20
OH 005T	PADDINGTON/150mm VERTICAL ARM	13	OH 038X *	RAINSTORM 600MM VERTICAL ARM	20
OH 005U	PADDINGTON/300mm VERTICAL ARM	13	OR 080C *	COSMIC/OVERHEAD RAIL 800MM	17
OH 005W	PADDINGTON/450mm VERTICAL ARM	13	OR 080Q	QUEWB/OVERHEAD RAIL 800MM	19
OH 005X	PADDINGTON/600mm VERTICAL ARM	13	PM 932	32mm PUSH PULL ME CRADLE ROD	94
OH 006A *	STREAMJET ROSE ONLY	14	SA 005	55mm LIMITED PROJECTION ARM	34
OH 006B *	STREAMJET/150mm FIXED ARM	14	SA 030 *	150mm UPSWEPT FIXED ARM	35
OH 006D *	STREAMJET/300mm CLICKLOCK ARM	14	SA 060 *	300mm CLICKLOCK ORB/ADJ ARM	34
OH 006E *	STREAMJET/290mm SWAN NECK ARM	14	SA 070 *	260MM UPSWEPT ADJUSTABLE ARM	35
OH 006G *	STREAMJET/165mm GRAND ARM	14	SA 090 *	290mm SWAN NECK ARM	34
OH 008A *	STREAMJET XL ROSE ONLY	15	SA 140 *	140mm SWIVEL CRANE NECK ARM	34
OH 008B *	STREAMJET XL/150mm FIXED ARM	15	SA 150 *	150MM VERTICAL ARM	35
OH 008D *	STREAMJET XL/300mm CLICKLOCK	15	SA 165 *	165mm GRAND ARM	34
OH 008E *	STREAMJET XL/290mm SWAN NECK	15	SA 300 *	300MM VERTICAL ARM	35
OH 008G	STREAMJET XL/165mm GRAND ARM	15	SA 310 *	310mm HORIZONTAL ARM	34
OH 028A *	COSMIC ROSE ONLY	16	SA 345 *	345mm SWIVEL SWAN NECK ARM	34
OH 028H *	COSMIC/310mm HORIZONTAL ARM	16	SA 380 *	380mm SWIVEL CRANE NECK ARM	34
OH 028K *	COSMIC/450mm HORIZONTAL ARM	16	SA 450 *	450MM VERTICAL ARM	35
OH 028Q *	COSMIC/380mm CRANE NECK ARM	16	SA 600 *	600MM VERTICAL ARM	35
OH 028T *	COSMIC/150mm VERTICAL ARM	17	SD 025 CL	25mm ABS SOAP DISH	35
OH 028U *	COSMIC/150mm VERTICAL ARM	17	SD 032 *	GRAB RAIL SOAP DISH HOLDER	94
OH 028W *	COSMIC/450mm VERTICAL ARM	17	SH 0025 *	25M BULK HOSE	38
OH 028X *	COSMIC/600mm VERTICAL ARM	17	SH 027 BL HW	20 WASHERS - NITRIL N70	39
OH 030A	QUEWB ROSE ONLY	18	SH 027 C CN-10	10 CONICAL END NUTS	39
OH 030H	QUEWB/310mm HORIZONTAL ARM	18	SH 027 C LV-20	20 HOSE SLEEVES - 15mm	39
OH 030Q	QUEWB/380mm CRANE NECK ARM	18	SH 027 C SV-20	20 HOSE SLEEVES - 14mm	39
OH 030T	QUEWB/150mm VERTICAL ARM	19	SH 027 GR EG-20	20 EEL GRIP SEALS - DELRIN	39
OH 030U	QUEWB/300mm VERTICAL ARM	19	SH 027 TR	TRADESMAN HOSE REPAIR KIT	39
OH 030W	QUEWB/450mm VERTICAL ARM	19	SH 0900 *	900MM HOSE	38
OH 030X	QUEWB/600mm VERTICAL ARM	19	SH 1200 *	1200MM HOSE	38
OH 038A *	RAINSTORM ROSE ONLY	20	SH 1500 *	1500MM HOSE	38

Code A-Z	Description	Page	Code A-Z	Description	Page
SH 2000 *	2000MM HOSE	38	TW 029CS	COSMIC/STREAMJET XL TURBO TWIN WATERS/CRANE	31
SH 3000 AW	3000MM ANTIMICROBIAL HOSE	52	TW 029CT	COSMIC/STREAMJET PULS TWIN WATERS/CRANE	31
SH 4000 AW	4000MM ANTIMICROBIAL HOSE	52	TW 029CX *	COSMIC/STREAMJET XL TWIN WATERS/CRANE	31
SL 850 *	850mm SWINGLOCK	91	TW 029CZ	COSMIC/BREEZE TWIN WATERS/CRANE	31
SP 063	ADJUSTABLE ARM OLIVE (2 PACK)	35	TW 035CJ *	COSMIC/STREAMJET TWIN WATERS BOTTOM INLET	30
SP 140 * TO	140mm SWIVEL CRANE TUBE ONLY	33	TW 035CP	COSMIC/PRINCESS TWIN WATERS BOTTOM INLET	30
SR 010 *	CRYSTAL SLIDE RAIL	33	TW 035CS	COSMIC/STREAMJET XL TURBO TWIN WATERS BOTTOM INLET	30
SR 020 *	POLAR SLIDE RAIL	33	TW 035CT	COSMIC/STREAMJET TURBO TWIN WATERS BOTTOM INLET	30
SR 025 *	SWAN NECK TWIN WATERS RAIL	33	TW 035CX *	COSMIC/STREAMJET XL TWIN WATERS BOTTOM INLET	30
SR 025 * OL	300mm OVERHEAD EXTENSION	33	TW 035CZ	COSMIC/BREEZE TWIN WATERS BOTTOM INLET	30
SR 025 * OM	200mm OVERHEAD EXTENSION	33	TW 039CJ *	COSMIC/STREAMJET TWIN WATERS BOTTOM INLET	31
SR 025 * OS	100mm OVERHEAD EXTENSION	33	TW 039CP	COSMIC/PRINCESS TWIN WATERS BOTTOM INLET	31
SR 026 *	RIVIERA SLIDE RAIL	33	TW 039CS	COSMIC/STREAMJET XL TURBO TWIN WATERS BOTTOM INLET	31
SR 028 C	QUEWB SLIDE RAIL	33	TW 039CT	COSMIC/STREAMJET TURBO TWIN WATERS BOTTOM INLET	31
SR 029 *	CRANE NECK TWIN WATERS RAIL	33	TW 039CX *	COSMIC/STREAMJET XL TWIN WATERS BOTTOM INLET	31
SR 400 C RA	400mm RAIL TUBE ONLY	33	TW 039CZ	COSMIC/BREEZE TWIN WATERS BOTTOM INLET	31
SR 700 *	700mm FRICT SLID/CRADLE/COLLAR	95	WB 001	COMFORT RECTANGULAR BASKET - LARGE	12
SS 604 *	600x400mm SAFE-ASSIST SHOWER SEAT	89	WB 002	COMFORT RECTANGULAR BASKET - MEDIUM	12
SS 645	450x600mm SEAT/LIMITED WALL	89	WB 003	COMFORT RECTANGULAR BASKET - SMALL	12
SS 845	800x450mm SHOWER SEAT	89	WB 004	COMFORT RECTANGULAR BASKET OPEN - MEDIUM	12
SS 945	960x450mm SAFE-ASSIST SHOWER SEAT	89	WB 005	COMFORT RECTANGULAR BASKET OPEN - SMALL	12
SS 964 *	960x400mm SAFE-ASSIST SHOWER SEAT	88	WB 006	COMFORT CORNER BASKET WITH HOOK	12
SS 965 *	960x500mm BARIATRIC SEAT	88	WB 008	COMFORT CORNER BASKET - MEDIUM	12
TL 850 *	TILTLOCK 850mm GRAB RAIL	90	WF 057 * DO	57mm BRASS DOMED FLANGE	33
TR 031 *	GRAB RAIL TOILET ROLL HOLDER	92	WF 057 * FL	57mm BRASS HD FLAT FLANGE	33
TW 025CJ *	COSMIC/STREAMJET TWIN WATERS	30	WF 057 * QU	57mm SQUARE WALL FLANGE	33
TW 025CP	COSMIC/PRINCESS TWIN WATERS	30			
TW 025CS	COSMIC/STREAMJET XL TURBO TWIN WATERS	30			
TW 025CT	COSMIC/STREAMJET PULS TWIN WATERS	30			
TW 025CX *	COSMIC/STREAMJET XL TWIN WATERS	30			
TW 025CZ	COSMIC/BREEZE TWIN WATERS	30			
TW 029CJ *	COSMIC/STREAMJET TWIN WATERS/CRANE	31			
TW 029CP	COSMIC/PRINCESS TWIN WATERS/CRANE	31			

* The asterisk represent code variations when there are multiple options available for finishes and/or orientation.

1. TERMS AND CONDITIONS TO APPLY

Con-Serv Corporation Australia Pty Ltd (ACN 010 372 639) (“**Con-Serv**”) and the buyer (“**Buyer**”) agree that these terms and conditions (“**Terms & Conditions**”) shall apply to the supply of all goods sold (“**Goods**”) by Con-Serv to the Buyer despite any prior agreements, prior offers, dealings or trade usage, or any terms communicated by the Buyer to Con-Serv. These Terms & Conditions supersede those in any previous form. The Buyer acknowledges and agrees that these Terms & Conditions may be varied from time to time and agrees to be bound by such varied Terms & Conditions.

2. QUOTATIONS

If Con-Serv has provided any quotation specifically for Goods, whether in writing or orally (“**Quotation**”):

- (a) These Terms & Conditions shall apply to the Quotation;
- (b) The Quotation shall remain valid for acceptance by the Buyer in writing for six (6) months after the date of the Quotation;
- (c) The Quotation will detail any charges for delivery of the Goods; and
- (d) The price in the Quotation shall be Con-Serv’s current price as at the date of Quotation and the price actually payable for the Goods shall be Con-Serv’s current price as at the date of the Buyer’s acceptance of the Quotation.

3. ORDERS

If the Buyer has made an order for Goods without there being a Quotation provided by Con-Serv (“**Order**”) the Order is subject to acceptance in writing by Con-Serv.

4. VARIATION OR CANCELLATION

After the Buyer’s acceptance of the Quotation or Con-Serv’s acceptance of the Order:

- (a) no change in the specification of Goods shall bind Con-Serv, unless Con-Serv expressly agrees to the change in writing; and
- (b) if the Buyer cancels or suspends the Order or Quotation after acceptance, the Buyer will pay Con-Serv any loss, damage or expenses incurred by Con-Serv in relation to the supply or proposed supply of the Goods.

5. CHARGE AND TAXES

- (a) The Buyer shall pay all taxes, levies, duties and assessments of every nature due in connection with the Goods supplied and hereby indemnifies and holds harmless Con-Serv from any liability on account of any and all such taxes, levies, duties, assessments and deductions; and
- (b) Unless otherwise expressly agreed by, or shown on an invoice issued by Con-Serv, the prices specified include GST. The Buyer must bear and pay all GST or any other tax or duty that may be imposed on or in relation to any supply.

6. PAYMENT

- (a) The Buyer shall pay for Goods within thirty (30) days from the date of the invoice issued by Con-Serv for the Goods. Time shall be of the essence in respect of payment for the Goods.
- (b) If payment is not made by the due date for payment, the Buyer shall pay to Con-Serv on demand interest at the rate of two percent (2%) per month until paid. This will not affect the other rights of Con-Serv.
- (c) The Buyer is not entitled to set off or withhold any payments to Con-Serv.
- (d) Con-Serv is entitled to recover from the Buyer, in addition to the price, any GST on the supply of the Goods except to the extent that the prices expressly include GST.
- (e) Con-Serv is entitled to recover from the Buyer, in addition to the price all losses, expenses, costs (including legal fees) on an indemnity basis and disbursements, consequent upon the Buyer’s failure to pay on the due date, are recoverable from the Buyer by Con-Serv as a liquidated debt.

7. DELIVERY/FREIGHT

- (a) Con-Serv will use all reasonable endeavours to deliver the Goods on or before the agreed date for delivery (“**Delivery Date**”), but:
 - (i) the Delivery Date is subject to extension for any delay caused by strikes, lockouts, war, breakdowns, accidents, delays in transport, fire or any cause beyond the reasonable control of Con-Serv; and
 - (ii) Con-Serv will not be liable for any loss, damage or other liability whether in contract, tort, negligence or otherwise and whether directly or indirectly arising from the Goods not being delivered by the Delivery Date for any reason.
- (b) The Buyer will be charged for all costs related to delivery and such costs will be detailed on the tax invoice provided to the Buyer.
- (c) The Buyer must ensure that sufficient access (including road surfaces capable of withstanding heavy loads) is provided at the place of delivery to enable the Goods to be delivered.
- (d) Con-Serv may, with the agreement of the Buyer, deliver Goods to the Buyer in instalments and in which case Con-Serv may separately invoice the Buyer for payment for each delivery instalment (which shall be taken to be the subject of a separate and distinct contract between the parties).

- (e) Any Goods returned are only accepted with the prior written approval of Con-Serv and may be subject to a 15% handling/restocking fee. “Freight collect” charges for returned Goods will be deducted from any credit note issued to the Buyer unless Con-Serv has agreed in writing in advance to accept the Freight collect charges.
- (f) Stock will only be accepted for return if it is undamaged and in its original packaging and condition.
- (g) The Buyer agrees to provide, at the Buyer’s expense (if requested by Con-Serv) assistance in unloading heavy Goods during delivery.
- (h) Goods which have been specifically manufactured by Con-Serv or altered by the Buyer cannot be returned simply because the Buyer has changed their mind;
- (i) The Buyer will be responsible for the offloading of Goods and the Buyer indemnifies Con-Serv against all claims whatsoever arising from the unloading of Goods.

8. RISK AND PROPERTY IN GOODS

- (a) For the purposes of the Personal Property Securities Act 2009 (as amended from time to time) (the “PPSA”) “Goods” means any and all present and after acquired goods supplied by Con-Serv to the Buyer;
- (b) The Goods shall be entirely at the risk (including loss, damage or deterioration) of the Buyer from the time of dispatch of the Goods (the carrier of the Goods shall be taken to be the agent of the Buyer).
- (c) Con-Serv retains full title to the Goods until Con-Serv receives payment in full for the Goods and all other amounts owed by the Buyer to Con-Serv.
- (d) Until all such monies have been paid:
 - (i) Con-Serv has the right to call for or recover possession of the Goods (for which purpose Con-Serv’s employees or agents may enter onto the Buyer’s premises) and the Buyer must deliver up the Goods if so directed by Con-Serv;
 - (ii) the Buyer:
 - (A) agrees that the relationship between the Buyer and Con-Serv shall be fiduciary and the Buyer shall keep the Goods safely, securely and separately stored and marked in a manner which clearly indicates that they belong to Con-Serv;
 - (B) shall not resell, encumber or dispose of the Goods;
 - (C) shall not mix the Goods or otherwise make them unable to be returned to Con-Serv in their original state;
 - (D) agrees that if, in breach of this clause, the Goods are incorporated with goods of the Buyer, the resultant product shall become and be deemed to be the sole property of Con-Serv. If the Goods are incorporated in any way with the property of a party other than the Buyer, the resultant product shall become and be deemed to be owned in common by Con-Serv with that other party (or parties) on a pro-rata basis to be calculated by reference to the cost to the Buyer of the incorporated materials; and
 - (E) will hold any proceeds (as that term is defined in the PPSA) of any resale, disposal or other dealing with the Goods or any product incorporating the Goods (including sale or supply to a party other than the Buyer) in breach of this clause in trust for Con-Serv and shall pay the proceeds into a separate fiduciary account to be held in trust for Con-Serv until accounted for to Con-Serv at the demand of Con-Serv.

- (e) To avoid any doubt, for the purposes of the PPSA, it is the intention of the parties by this clause 7 that there is created for the benefit of Con-Serv a security interest and a Purchase Money Security interest in the Goods;
- (f) The Buyer agrees that Con-Serv may register any personal property security interest created by the Terms & Conditions on the Personal Property Securities Register and the Buyer waives its rights to receive a verification statement (as that term is defined in the PPSA) in respect of any financing statement or financing change statement (as those terms are defined in the PPSA) registered by Con-Serv in respect of any personal property of the Buyer. Con-Serv and the Buyer agree that, insofar as the provisions of Chapter 4 of the PPSA are for the benefit of the Buyer or place an obligation on Con-Serv, those provisions will apply only to the extent that they cannot be contracted out of or to the extent that Con-Serv otherwise agrees in writing.

9. LIABILITY

The Buyer agrees that:

- (a) the Buyer must satisfy itself as to the truth and accuracy of and may not rely for any purpose upon, any advice description of Goods or information provided by or on behalf of Con-Serv in connection with Goods or the Terms & Conditions;
- (b) except to the extent prohibited by law, the only remedy of the Buyer against Con-Serv for any loss, damage or liability whether in contract, tort, negligence or otherwise of the Buyer in connection with the Terms & Conditions, the Goods, Con-Serv’s supply of the Goods or Con-Serv’s failure to supply the Goods to the Buyer in accordance with the Terms & Conditions shall be limited to Con-Serv, at its option, replacing the Goods; and

- (c) Con-Serv shall otherwise have no liability to the Buyer whether in contract, tort, negligence or otherwise.
- (d) Water board requirements are not uniform throughout Australia. Con-Serv do not accept any responsibility for any damage or claims resulting from the installation of Goods where the installation does not conform with Water board requirements for the Australian state in which the installation was performed.

10. DEFECTIVE GOODS

- (a) Within seven (7) days after the delivery of the Goods the Buyer shall both complete any inspection required by it to confirm the Goods comply with the Terms & Conditions and notify Con-Serv in writing (detailed the tax invoice number and date) of the extent to which the Goods do not comply with the Terms & Conditions.
- (b) The Buyer shall not use the Goods (other than to the extent reasonably necessary for the inspection) before the Buyer completes the inspection and testing and satisfies itself that the Goods comply with the Terms & Conditions, or, if the Buyer notifies Con-Serv in writing that the Goods do not comply with the Terms & Conditions, Con-Serv has had a reasonable opportunity to inspect and test the Goods after Con-Serv receives that notice.
- (c) If the Buyer does not comply with clause 9(a), the Buyer shall be taken to have unconditionally accepted the Goods and the Buyer must comply with the Terms & Conditions.

11. CHARGING CLAUSE

- (a) To secure payment of all monies which are or may become payable by the Buyer to Con-Serv under these Terms & Conditions the Buyer (or where the Buyer is comprised of two or more persons or other entities then each person and other entity jointly and severally) hereby charges as beneficial owner and as trustee of any trust in favour of Con-Serv all the Buyers' right, title and interest in land (held now or in the future) with the due payment of all of those monies. The Buyer acknowledges that Con-Serv may register a caveat or caveats over the Buyer's land in respect of this charge.
- (b) If the Buyer is a trustee of any trust:
 - (i) it is bound by these Terms & Conditions and charges the Buyer's land as trustee;
 - (ii) warrants that it is a proper exercise of the Buyer's authority and power under the trust instrument and at law to trade with Con-Serv and to charge the Buyer's land in accordance with these Terms & Conditions.
- (c) Upon demand by Con-Serv, the Buyer agrees to immediately execute a mortgage or other instrument in terms satisfactory to Con-Serv to further secure the Buyer's indebtedness to the Con-Serv.
- (d) Should the Buyer fail within a reasonable time of such demand to execute such mortgage or other instrument then the Buyer appoints irrevocably the credit manager or a duly authorised officer of Con-Serv to be the Buyer's lawful attorney to execute any such mortgage or other instrument.

12. TRUST AND TRUSTEES

Where the Buyer is a trustee of any trust:-

- (a) The Buyer agrees to produce immediately to Con-Serv a stamped copy of the trust deed (including all amendments) upon written notice from Con-Serv.
- (b) The Buyer warrants that it has full power and authority to enter into these Terms & Conditions on behalf of the trust and that it shall be bound by these Terms & Conditions both personally and as trustee and clauses 10 and 11 extend to any land held by the Buyer as trustee.

13. BUYER SPECIFICATION/SPECIAL ORDERS/INTELLECTUAL PROPERTY

- (a) If any Goods are manufactured by Con-Serv to the design or specification of the Customer, the Buyer warrants to Con-Serv that any drawings, plans, specifications and other design information provided to Con-Serv for the manufacture of such Goods are accurate and correct in all respects and do not infringe upon the intellectual property rights of any third party including any copyright, patents, designs or trademarks of the third party;
- (b) Where the design of Goods supplied by Con-Serv to the Buyer is provided by the Buyer (or its nominee) to Con-Serv, or the design is provided by Con-Serv in accordance with specifications provided by the Customer, the Buyer will accept sole responsibility for the design and is responsible for the suitability for the Goods for the purposes for which they were designed and acquired;
- (c) "Proprietary Information" means any and all information relating to Goods and/or the installation or operation of Goods (including all intellectual property therein) supplied by Con-Serv to the Buyer and the Buyer acknowledges that all Proprietary Information and all right title and interest therein are the sole property of or licensed by Con-Serv and the Buyer shall gain no right title or interest in the Proprietary Information whatsoever.

The Buyer specifically acknowledges Con-Serv's exclusive rights to ownership of any modification, translation or adaptation of the Proprietary Information and any other improvement or development based thereon which is developed supplied installed or paid for by or on behalf of the Customer;

- (d) The Buyer agrees to indemnify Con-Serv in respect of any loss, damage, expense, claim or liability suffered or incurred by Con-Serv as a result of any claim by a third party asserting infringement of any intellectual property rights in relation to such Goods or any breach by the Buyer of this clause 18 or any claims against Con-Serv arising out of any matters referred to in this clause 18.

14. NO EXPORT

- (a) Unless otherwise agreed in writing by Con-Serv, any Goods supplied to the Buyer are intended for use in Australia only such that if any such Goods are exported by the Buyer, it is the responsibility of the Buyer to ensure those Goods comply with the laws of any foreign country to which the Goods are exported.
- (b) The Buyer agrees to indemnify Con-Serv in respect of any loss, damage, expense, claim or liability suffered or incurred by Con-Serv as a result of any breach by the Buyer of this section 14 or any claims against Con-Serv arising out of any matters referred to in this section 14.

15. DEFAULT, INSOLVENCY AND TERMINATION

If the Buyer:

- (a) commits a substantial breach of the Terms & Conditions including unreasonably refusing to accept any Goods or failing to pay for any Goods, in accordance with the Terms & Conditions; or
 - (b) informs any person it is insolvent, commits an act of bankruptcy, has a bankruptcy petition presented against it, becomes bankrupt, becomes subject to or bound by any arrangement, assignment, composition or moratorium of debts with its creditors, official management, receivership, liquidation, voluntary administration, winding up or other external administration,
- Con-Serv may, without affecting Con-Serv 's other rights:
- (c) immediately terminate the supply of the Goods, by notice in writing to the Buyer;
 - (d) refuse, suspend or withhold any further Goods;
 - (e) enter upon (personally or by its employees or agents) any premises in the possession or control of the Buyer and use reasonable force for the purposes of retaking possession of any of the Goods (title to which has not passed to the Buyer), in which case the sale of those Goods shall be taken to be terminated and Con-Serv shall have no liability to the Buyer whether for trespass, negligence, payment of damages or compensation or otherwise;
 - (f) terminate any credit arrangement with the Buyer, by notice in writing to the Buyer (in which case outstanding amounts will become immediately due and payable);

16. GOVERNING LAW

The laws of the State of Queensland shall apply to the Terms & Conditions and the parties submit to the exclusive jurisdiction of the Courts in Brisbane.

17. NON-WAIVER

Con-Serv's failure to exercise any right under the Terms & Conditions or failure to insist on strict performance of any part of the Terms & Conditions does not operate as a waiver and a partial exercise of a right does not preclude any further or fuller exercise of that right.

18. SEVERANCE

If any part of these Terms and Conditions or any related document is or becomes void or unenforceable that part is severed so that all parts which are not void or unenforceable remain in full force and effect and are unaffected by the severance.

19. NOTICES

- (a) Notices required to be given by the Buyer to Con-Serv pursuant to these Terms and Conditions may be delivered to Con-Serv:
 - (i) personally or by post to Con-Serv at 17 Glentanna Street, Kedron, Queensland 4031; or
 - (ii) by email to Con-Serv at mail@con-serv.com.au.
- (b) Notices will be taken as delivered when received by Con-Serv.
- (c) Notices required to be given by Con-Serv to the Buyer pursuant to these Terms and Conditions may be delivered:
 - (i) by post to the Buyer's last known address (and shall be taken as delivered on the second business day following posting); or
 - (ii) by email to the Buyer's last known email address.



CON-SERV CORPORATION AUSTRALIA PTY. LTD.
17 Glentanna Street, Kedron Qld. 4031 Australia
Phone: +61 (0)7 3630 5744 · Fax: +61 (0)7 3630 5755
Email: mail@con-serv.com.au · www.con-serv.com.au